

Appendix D
Slope Stability Analyses

A-A' / Existing Grade / Search Along Clay / Caissons and Tiebacks

z:\2010\10132-01 south shores church - dana point\engineering\2012_10\proposed design\aa'_4c.pl2 Run By: Username 10/24/2012 03:27PM

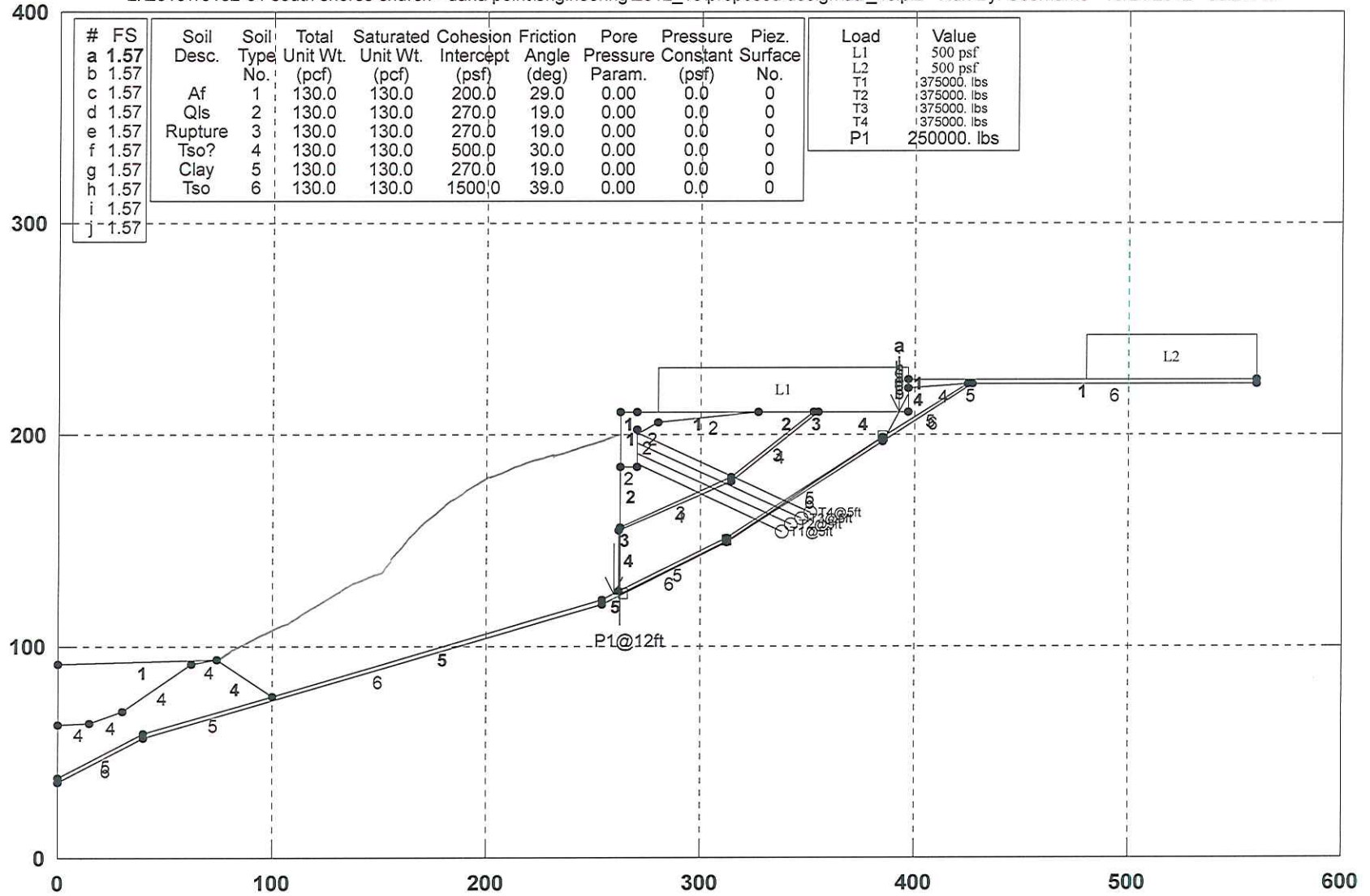

#	FS	Soil Desc.	Soil Type No.	Total Unit Wt. (pcf)	Saturated Unit Wt. (pcf)	Cohesion Intercept (psf)	Friction Angle (deg)	Pore Pressure Param.	Pressure Constant (psf)	Piez. Surface No.
a	1.57									
b	1.57									
c	1.57	Af	1	130.0	130.0	200.0	29.0	0.00	0.0	0
d	1.57	Qls	2	130.0	130.0	270.0	19.0	0.00	0.0	0
e	1.57	Rupture	3	130.0	130.0	270.0	19.0	0.00	0.0	0
f	1.57	Tso?	4	130.0	130.0	500.0	30.0	0.00	0.0	0
g	1.57	Clay	5	130.0	130.0	270.0	19.0	0.00	0.0	0
h	1.57	Tso	6	130.0	130.0	1500.0	39.0	0.00	0.0	0
i	1.57									
j	1.57									

Load	Value
L1	500 psf
L2	500 psf
T1	375000. lbs
T2	375000. lbs
T3	375000. lbs
T4	375000. lbs
P1	250000. lbs

GSTABL7 v.2 FSmin=1.57

Safety Factors Are Calculated By The Simplified Janbu Method for the case of c & phi both > 0

*** GSTABL7 ***

** GSTABL7 by Dr. Garry H. Gregory, Ph.D.,P.E.,D.GE **

** Original Version 1.0, January 1996; Current Ver. 2.005.2, Jan. 2011 **
(All Rights Reserved-Unauthorizd Use Prohibited)

SLOPE STABILITY ANALYSIS SYSTEM

Modified Bishop, Simplified Janbu, or GLE Method of Slices.
(Includes Spencer & Morgenstern-Price Type Analysis)
Including Pier/Pile, Reinforcement, Soil Nail, Tieback,
Nonlinear Undrained Shear Strength, Curved Phi Envelope,
Anisotropic Soil, Fiber-Reinforced Soil, Boundary Loads, Water
Surfaces, Pseudo-Static & Newmark Earthquake, and Applied Forces.

Analysis Run Date: 10/24/2012
Time of Run: 03:27PM
Run By: Username
Input Data Filename: Z:\2010\10132-01 South Shores Church - Dana Point\Engineerin
g\2012_10\Proposed Design\aa'_4c.
Output Filename: Z:\2010\10132-01 South Shores Church - Dana Point\Engineerin
g\2012_10\Proposed Design\aa'_4c.OUT
Unit System: English
Plotted Output Filename: Z:\2010\10132-01 South Shores Church - Dana Point\Engineerin
g\2012_10\Proposed Design\aa'_4c.PLT
PROBLEM DESCRIPTION: A-A' / Existing Grade / Search Along
Clay / Caissons and Tiebacks

BOUNDARY COORDINATES

Boundary No.	X-Left (ft)	Y-Left (ft)	X-Right (ft)	Y-Right (ft)	Soil Type
16 Top Boundaries					
41 Total Boundaries					
1	0.00	92.00	74.00	94.00	1
2	74.00	94.00	100.00	76.60	4
3	100.00	76.60	254.00	122.00	5
4	254.00	122.00	262.00	126.00	5
5	262.00	126.00	262.10	154.40	4
6	262.10	154.40	262.20	156.40	3
7	262.20	156.40	262.30	185.00	2
8	262.30	185.00	262.40	211.00	1
9	262.40	211.00	270.20	211.00	1
10	270.20	211.00	327.00	211.00	1
11	327.00	211.00	353.00	211.00	2
12	353.00	211.00	355.00	211.00	3
13	355.00	211.00	397.00	211.00	4
14	397.00	211.00	397.10	222.00	4
15	397.10	222.00	397.20	226.00	1
16	397.20	226.00	560.00	226.00	1
17	397.10	222.00	425.00	224.00	4
18	425.00	224.00	427.00	224.00	5
19	427.00	224.00	560.00	224.00	6
20	262.30	185.00	270.00	185.00	2
21	270.00	185.00	270.10	202.00	2
22	270.10	200.00	280.00	206.00	2
23	280.00	206.00	327.00	211.00	2
24	0.00	63.00	15.00	64.00	4
25	15.00	64.00	30.00	69.00	4
26	30.00	69.00	62.00	92.00	4
27	62.00	92.00	74.00	94.00	4
28	262.20	156.40	314.00	180.00	3
29	314.00	180.00	353.00	211.00	3
30	262.10	154.40	314.00	178.00	4
31	314.00	178.00	355.00	211.00	4
32	0.00	38.00	40.00	59.00	5
33	40.00	59.00	100.00	76.60	5
34	262.00	126.00	312.00	151.00	5
35	312.00	151.00	385.00	199.00	5
36	385.00	199.00	425.00	224.00	5
37	0.00	36.00	40.00	57.00	6
38	40.00	57.00	254.00	120.00	6
39	254.00	120.00	312.00	149.00	6
40	312.00	149.00	385.00	197.00	6

41 385.00 197.00 427.00 224.00 6

Default Y-Origin = 0.00(ft)
Default X-Plus Value = 0.00(ft)
Default Y-Plus Value = 0.00(ft)

ISOTROPIC SOIL PARAMETERS

Soil No.	Total (pcf)	Saturated (pcf)	Cohesion (psf)	Friction (deg)	Pore Pressure Param. (psf)	Piez. Constant Surface
1	130.0	130.0	200.0	29.0	0.00	0.0
2	130.0	130.0	270.0	19.0	0.00	0.0
3	130.0	130.0	270.0	19.0	0.00	0.0
4	130.0	130.0	500.0	30.0	0.00	0.0
5	130.0	130.0	270.0	19.0	0.00	0.0
6	130.0	130.0	1500.0	39.0	0.00	0.0

BOUNDARY LOAD(S)

Load No.	X-Left (ft)	X-Right (ft)	Intensity (psf)	Deflection (deg)
1	280.00	397.00	500.0	0.0
2	480.00	560.00	500.0	0.0

NOTE - Intensity Is Specified As A Uniformly Distributed Force Acting On A Horizontally Projected Surface.

TIEBACK LOAD(S)

Tieback No.	X-Pos (ft)	Y-Pos (ft)	Load (lbs)	Spacing (ft)	Inclination (deg)	Length (ft)	Force Method
1	270.01	186.00	375000.0	5.0	25.00	75.0	2
2	270.04	191.00	375000.0	5.0	25.00	80.0	2
3	270.06	196.00	375000.0	5.0	25.00	85.0	2
4	270.09	201.00	375000.0	5.0	25.00	90.0	2

NOTE - An Equivalent Line Load Is Calculated For Each Row Of Tiebacks Assuming A Uniform Distribution Of Load Horizontally Between Individual Tiebacks. Force Method 1 Considers Only Tangential Tieback Forces. Force Method 2 Considers Both Tangential and Normal Tieback Forces. Force Method 3 Considers Only Normal Tieback Forces. Force Method 4 Limits Normal and Tangential Tieback-Force Distribution to 1.5 Times the Tieback Inclination, or to 30 Degrees Below (Left of) the Tieback-Failure Surface Intersection, Whichever is Greater.

PIER/PILE LOAD(S)

Pier/Pile No.	X-Pos (ft)	Y-Pos (ft)	Load (lbs)	Spacing (ft)	Inclination (deg)	Length (ft)
1	262.40	185.00	250000.0	12.0	90.00	75.0

NOTE - An Equivalent Line Load Is Calculated For Each Row Of Piers/Piles Assuming A Uniform Distribution Of Load Horizontally Between Individual Piers/Piles.

Janbus Empirical Coef is being used for the case of c & phi both > 0
A Critical Failure Surface Searching Method, Using A Random Technique For Generating Sliding Block Surfaces, Has Been Specified.

5000 Trial Surfaces Have Been Generated.
3 Boxes Specified For Generation Of Central Block Base
Length Of Line Segments For Active And Passive Portions Of Sliding Block Is 80.0

Box No.	X-Left (ft)	Y-Left (ft)	X-Right (ft)	Y-Right (ft)	Height (ft)
1	262.10	125.00	266.10	125.00	5.00
2	310.00	150.00	314.00	150.00	5.00
3	383.00	199.00	387.00	199.00	5.00

The Factor Of Safety For The Trial Failure Surface Defined By The Coordinates Listed Below Is Misleading.

Point No.	X-Surf (ft)	Y-Surf (ft)
1	262.01	128.57
2	265.59	126.49
3	312.13	149.29
4	383.44	197.63
5	383.48	211.00

Factor Of Safety For The Preceding Specified Surface = -2.247
 The Factor Of Safety For The Trial Failure Surface Defined
 By The Coordinates Listed Below Is Misleading.
 Failure Surface Defined By 5 Coordinate Points

Point No.	X-Surf (ft)	Y-Surf (ft)
1	262.01	128.57
2	265.59	126.49
3	312.13	149.29
4	383.44	197.63
5	383.48	211.00

Factor Of Safety For The Preceding Specified Surface = -2.247
 The Factor Of Safety For The Trial Failure Surface Defined
 By The Coordinates Listed Below Is Misleading.
 Failure Surface Defined By 5 Coordinate Points

Point No.	X-Surf (ft)	Y-Surf (ft)
1	262.01	128.57
2	265.59	126.49
3	312.13	149.29
4	383.44	197.63
5	383.48	211.00

Factor Of Safety For The Preceding Specified Surface = -2.247
 The Factor Of Safety For The Trial Failure Surface Defined
 By The Coordinates Listed Below Is Misleading.
 Failure Surface Defined By 5 Coordinate Points

Point No.	X-Surf (ft)	Y-Surf (ft)
1	262.01	128.57
2	265.59	126.49
3	312.13	149.29
4	383.44	197.63
5	383.48	211.00

Factor Of Safety For The Preceding Specified Surface = -2.247
 The Factor Of Safety For The Trial Failure Surface Defined
 By The Coordinates Listed Below Is Misleading.
 Failure Surface Defined By 5 Coordinate Points

Point No.	X-Surf (ft)	Y-Surf (ft)
1	262.01	128.57
2	265.59	126.49
3	312.13	149.29
4	383.44	197.63
5	383.48	211.00

Factor Of Safety For The Preceding Specified Surface = -2.247
 The Factor Of Safety For The Trial Failure Surface Defined
 By The Coordinates Listed Below Is Misleading.
 Failure Surface Defined By 5 Coordinate Points

Point No.	X-Surf (ft)	Y-Surf (ft)
1	262.01	128.57
2	265.59	126.49
3	312.13	149.29
4	383.44	197.63
5	383.48	211.00

Factor Of Safety For The Preceding Specified Surface = -2.247
 The Factor Of Safety For The Trial Failure Surface Defined
 By The Coordinates Listed Below Is Misleading.
 Failure Surface Defined By 5 Coordinate Points

Point No.	X-Surf (ft)	Y-Surf (ft)
1	262.01	128.57
2	265.59	126.49
3	312.13	149.29
4	383.44	197.63
5	383.48	211.00

Factor Of Safety For The Preceding Specified Surface = -2.247
 The Factor Of Safety For The Trial Failure Surface Defined
 By The Coordinates Listed Below Is Misleading.
 Failure Surface Defined By 5 Coordinate Points

Point No.	X-Surf (ft)	Y-Surf (ft)
1	262.01	128.57
2	265.59	126.49
3	312.13	149.29
4	383.44	197.63
5	383.48	211.00

Factor Of Safety For The Preceding Specified Surface = -2.247
 The Factor Of Safety For The Trial Failure Surface Defined
 By The Coordinates Listed Below Is Misleading.
 Failure Surface Defined By 5 Coordinate Points

Point No.	X-Surf (ft)	Y-Surf (ft)
1	262.01	128.57
2	265.59	126.49
3	312.13	149.29
4	383.44	197.63
5	383.48	211.00

Factor Of Safety For The Preceding Specified Surface = -2.247
 The Factor Of Safety For The Trial Failure Surface Defined
 By The Coordinates Listed Below Is Misleading.
 Failure Surface Defined By 5 Coordinate Points

Point No.	X-Surf (ft)	Y-Surf (ft)
1	262.01	128.57
2	265.59	126.49
3	312.13	149.29
4	383.44	197.63
5	383.48	211.00

Factor Of Safety For The Preceding Specified Surface = -2.247
 Following Are Displayed The Ten Most Critical Of The Trial
 Failure Surfaces Evaluated. They Are
 Ordered - Most Critical First.

* * * Safety Factors Are Calculated By The Simplified Janbu Method * *

Total Number of Trial Surfaces Attempted = 5000

Number of Trial Surfaces With Misleading FS = 10

Number of Trial Surfaces With Valid FS = 4990

Percentage of Trial Surfaces With Non-Valid FS Solutions

of the Total Attempted = 0.2 %

Statistical Data On All Valid FS Values:

FS Max = 373.920 FS Min = 1.567 FS Ave = 3.427

Standard Deviation = 16.618 Coefficient of Variation = 484.89 %

Failure Surface Specified By 5 Coordinate Points

Point No.	X-Surf (ft)	Y-Surf (ft)
1	259.434	124.717
2	262.261	124.284
3	312.675	150.053
4	386.860	200.115
5	393.006	211.000

Factor of Safety
 *** 1.567 ***

Individual data on the 20 slices

Slice No.	Width (ft)	Weight (lbs)	Water Force		Tie Norm (lbs)	Tie Tan (lbs)	Earthquake Force		Surcharge Load (lbs)
			Top (lbs)	Bot (lbs)			Hor (lbs)	Ver (lbs)	
1	2.6	279.5	0.0	0.0	0.0	0.0	0.0	0.0	0.0
2	0.1	206.4	0.0	0.0	88.0	3.0	0.0	0.0	0.0
3	0.1	404.3	0.0	0.0	89.0	3.0	0.0	0.0	0.0
4	0.1	323.1	0.0	0.0	54.0	2.0	0.0	0.0	0.0
5	0.0	280.1	0.0	0.0	32.0	0.0	0.0	0.0	0.0
6	0.1	957.7	0.0	0.0	83.0	0.0	0.0	0.0	0.0
7	7.6	83685.8	0.0	0.0	7813.0	0.0	0.0	0.0	0.0
8	0.1	1075.6	0.0	0.0	125.0	0.0	0.0	0.0	0.0
9	0.1	1074.9	0.0	0.0	126.0	0.0	0.0	0.0	0.0
10	9.8	102114.7	0.0	0.0	15493.0	0.0	0.0	0.0	0.0
11	32.0	288994.5	0.0	0.0	93772.0	1721.0	0.0	0.0	16000.0
12	0.7	5359.7	0.0	0.0	2135.0	671.0	0.0	0.0	337.3
13	1.3	10424.5	0.0	0.0	4638.0	949.0	0.0	0.0	662.7

14	13.0	94075.2	0.0	0.0	43831.	15240.	0.0	0.0	6500.0
15	26.0	143673.0	0.0	0.0	64760.	47563.	0.0	0.0	13000.0
16	2.0	8595.4	0.0	0.0	3683.	3726.	0.0	0.0	1000.0
17	30.0	86822.4	0.0	0.0	38619.	51343.	0.0	0.0	15000.0
18	1.9	2783.8	0.0	0.0	1705.	2808.	0.0	0.0	930.1
19	0.0	58.0	0.0	0.0	102.	65.	0.0	0.0	20.6
20	6.1	4290.1	0.0	0.0	13957.	9768.	0.0	0.0	3052.3

Failure Surface Specified By 5 Coordinate Points

Point No.	X-Surf (ft)	Y-Surf (ft)
1	259.434	124.717
2	262.261	124.284
3	312.675	150.053
4	386.860	200.115
5	393.006	211.000

Factor of Safety
*** 1.567 ***

Failure Surface Specified By 5 Coordinate Points

Point No.	X-Surf (ft)	Y-Surf (ft)
1	259.434	124.717
2	262.261	124.284
3	312.675	150.053
4	386.860	200.115
5	393.006	211.000

Factor of Safety
*** 1.567 ***

Failure Surface Specified By 5 Coordinate Points

Point No.	X-Surf (ft)	Y-Surf (ft)
1	259.434	124.717
2	262.261	124.284
3	312.675	150.053
4	386.860	200.115
5	393.006	211.000

Factor of Safety
*** 1.567 ***

Failure Surface Specified By 5 Coordinate Points

Point No.	X-Surf (ft)	Y-Surf (ft)
1	259.434	124.717
2	262.261	124.284
3	312.675	150.053
4	386.860	200.115
5	393.006	211.000

Factor of Safety
*** 1.567 ***

Failure Surface Specified By 5 Coordinate Points

Point No.	X-Surf (ft)	Y-Surf (ft)
1	259.434	124.717
2	262.261	124.284
3	312.675	150.053
4	386.860	200.115
5	393.006	211.000

Factor of Safety
*** 1.567 ***

Failure Surface Specified By 5 Coordinate Points

Point No.	X-Surf (ft)	Y-Surf (ft)
1	259.434	124.717
2	262.261	124.284
3	312.675	150.053
4	386.860	200.115
5	393.006	211.000

Factor of Safety
*** 1.567 ***

Failure Surface Specified By 5 Coordinate Points

Point No.	X-Surf (ft)	Y-Surf (ft)
-----------	-------------	-------------

1	259.434	124.717
2	262.261	124.284
3	312.675	150.053
4	386.860	200.115
5	393.006	211.000

Factor of Safety
*** 1.567 ***

Failure Surface Specified By 5 Coordinate Points

Point No.	X-Surf (ft)	Y-Surf (ft)
1	259.434	124.717
2	262.261	124.284
3	312.675	150.053
4	386.860	200.115
5	393.006	211.000

Factor of Safety
*** 1.567 ***

Failure Surface Specified By 5 Coordinate Points

Point No.	X-Surf (ft)	Y-Surf (ft)
1	259.434	124.717
2	262.261	124.284
3	312.675	150.053
4	386.860	200.115
5	393.006	211.000

Factor of Safety
*** 1.567 ***

**** END OF GSTABL7 OUTPUT ****

A-A' / Existing Grade / Search Along Clay / Caissons and Tiebacks / Pseudo

z:\2010\10132-01 south shores church - dana point\engineering\2012_10\proposed design\aa'_4cp.pl2 Run By: Username 10/23/2012 11:17AM

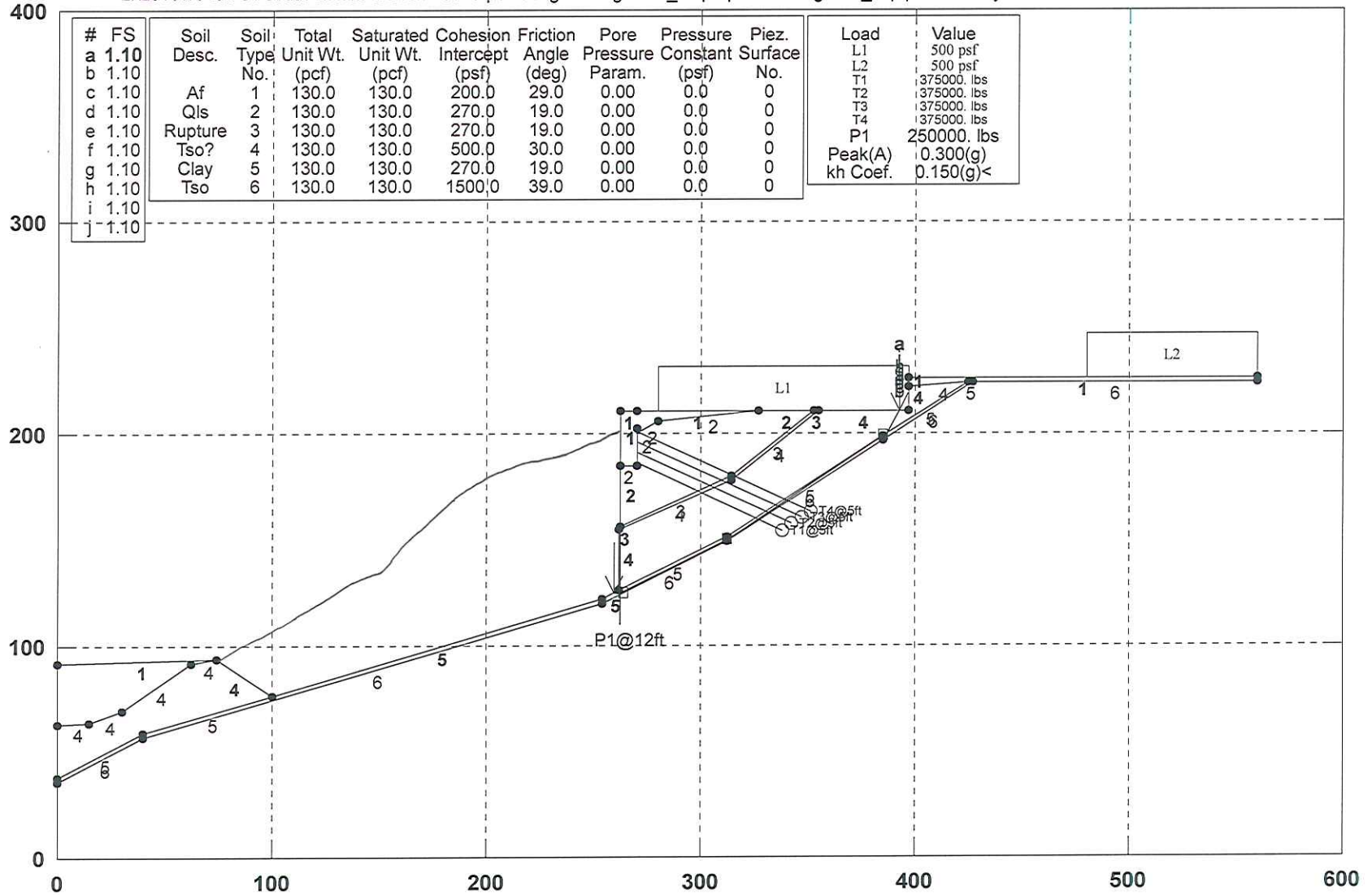

GSTABL7 v.2 FSmin=1.10

Safety Factors Are Calculated By The Simplified Janbu Method for the case of c & phi both > 0

*** GSTABL7 ***

** GSTABL7 by Dr. Garry H. Gregory, Ph.D., P.E., D.GE **

** Original Version 1.0, January 1996; Current Ver. 2.005.2, Jan. 2011 **
(All Rights Reserved-Unauthorized Use Prohibited)

SLOPE STABILITY ANALYSIS SYSTEM

Modified Bishop, Simplified Janbu, or GLE Method of Slices.

(Includes Spencer & Morgenstern-Price Type Analysis)

Including Pier/Pile, Reinforcement, Soil Nail, Tieback,

Nonlinear Undrained Shear Strength, Curved Phi Envelope,

Anisotropic Soil, Fiber-Reinforced Soil, Boundary Loads, Water

Surfaces, Pseudo-Static & Newmark Earthquake, and Applied Forces.

Analysis Run Date: 10/23/2012

Time of Run: 11:17AM

Run By: Username

Input Data Filename: Z:\2010\10132-01 South Shores Church - Dana Point\Engineerin
g\2012_10\Proposed Design\aa'_4cp.

Output Filename: Z:\2010\10132-01 South Shores Church - Dana Point\Engineerin
g\2012_10\Proposed Design\aa'_4cp.OUT

Unit System: English

Plotted Output Filename: Z:\2010\10132-01 South Shores Church - Dana Point\Engineerin
g\2012_10\Proposed Design\aa'_4cp.PLT

PROBLEM DESCRIPTION: A-A' / Existing Grade / Search Along
Clay / Caissons and Tiebacks / Pseudo

BOUNDARY COORDINATES

16 Top Boundaries

41 Total Boundaries

Boundary No.	X-Left (ft)	Y-Left (ft)	X-Right (ft)	Y-Right (ft)	Soil Type Below Bnd
1	0.00	92.00	74.00	94.00	1
2	74.00	94.00	100.00	76.60	4
3	100.00	76.60	254.00	122.00	5
4	254.00	122.00	262.00	126.00	5
5	262.00	126.00	262.10	154.40	4
6	262.10	154.40	262.20	156.40	3
7	262.20	156.40	262.30	185.00	2
8	262.30	185.00	262.40	211.00	1
9	262.40	211.00	270.20	211.00	1
10	270.20	211.00	327.00	211.00	1
11	327.00	211.00	353.00	211.00	2
12	353.00	211.00	355.00	211.00	3
13	355.00	211.00	397.00	211.00	4
14	397.00	211.00	397.10	222.00	4
15	397.10	222.00	397.20	226.00	1
16	397.20	226.00	560.00	226.00	1
17	397.10	222.00	425.00	224.00	4
18	425.00	224.00	427.00	224.00	5
19	427.00	224.00	560.00	224.00	6
20	262.30	185.00	270.00	185.00	2
21	270.00	185.00	270.10	202.00	2
22	270.10	200.00	280.00	206.00	2
23	280.00	206.00	327.00	211.00	2
24	0.00	63.00	15.00	64.00	4
25	15.00	64.00	30.00	69.00	4
26	30.00	69.00	62.00	92.00	4
27	62.00	92.00	74.00	94.00	4
28	262.20	156.40	314.00	180.00	3
29	314.00	180.00	353.00	211.00	3
30	262.10	154.40	314.00	178.00	4
31	314.00	178.00	355.00	211.00	4
32	0.00	38.00	40.00	59.00	5
33	40.00	59.00	100.00	76.60	5
34	262.00	126.00	312.00	151.00	5
35	312.00	151.00	385.00	199.00	5
36	385.00	199.00	425.00	224.00	5
37	0.00	36.00	40.00	57.00	6
38	40.00	57.00	254.00	120.00	6
39	254.00	120.00	312.00	149.00	6
40	312.00	149.00	385.00	197.00	6

41 385.00 197.00 427.00 224.00 6

Default Y-Origin = 0.00(ft)

Default X-Plus Value = 0.00(ft)

Default Y-Plus Value = 0.00(ft)

ISOTROPIC SOIL PARAMETERS

6 Type(s) of Soil

Soil Type	Total Unit Wt. (pcf)	Saturated Unit Wt. (pcf)	Cohesion (psf)	Friction Angle (deg)	Pore Pressure Param. (psf)	Pressure Constant (psf)	Piez. Surface No.
1	130.0	130.0	200.0	29.0	0.00	0.0	0
2	130.0	130.0	270.0	19.0	0.00	0.0	0
3	130.0	130.0	270.0	19.0	0.00	0.0	0
4	130.0	130.0	500.0	30.0	0.00	0.0	0
5	130.0	130.0	270.0	19.0	0.00	0.0	0
6	130.0	130.0	1500.0	39.0	0.00	0.0	0

BOUNDARY LOAD(S)

2 Load(s) Specified

Load No.	X-Left (ft)	X-Right (ft)	Intensity (psf)	Deflection (deg)
1	280.00	397.00	500.0	0.0
2	480.00	560.00	500.0	0.0

NOTE - Intensity Is Specified As A Uniformly Distributed

Force Acting On A Horizontally Projected Surface.

Specified Peak Ground Acceleration Coefficient (A) = 0.300(g)

Specified Horizontal Earthquake Coefficient (kh) = 0.150(g)

Specified Vertical Earthquake Coefficient (kv) = 0.000(g)

Specified Seismic Pore-Pressure Factor = 0.000

TIEBACK LOAD(S)

4 Tieback Load(s) Specified

Tieback No.	X-Pos (ft)	Y-Pos (ft)	Load (lbs)	Spacing (ft)	Inclination (deg)	Length (ft)	Force Method
1	270.01	186.00	375000.0	5.0	25.00	75.0	2
2	270.04	191.00	375000.0	5.0	25.00	80.0	2
3	270.06	196.00	375000.0	5.0	25.00	85.0	2
4	270.09	201.00	375000.0	5.0	25.00	90.0	2

NOTE - An Equivalent Line Load Is Calculated For Each Row Of Tiebacks

Assuming A Uniform Distribution Of Load Horizontally Between Individual

Tiebacks. Force Method 1 Considers Only Tangential Tieback Forces.

Force Method 2 Considers Both Tangential and Normal Tieback Forces.

Force Method 3 Considers Only Normal Tieback Forces.

Force Method 4 Limits Normal and Tangential Tieback-Force Distribution

to 1.5 Times the Tieback Inclination, or to 30 Degrees Below (Left of)

the Tieback-Failure Surface Intersection, Whichever is Greater.

PIER/PILE LOAD(S)

1 Pier/Pile Load(s) Specified

Pier/Pile No.	X-Pos (ft)	Y-Pos (ft)	Load (lbs)	Spacing (ft)	Inclination (deg)	Length (ft)
1	262.40	185.00	250000.0	12.0	90.00	75.0

NOTE - An Equivalent Line Load Is Calculated For Each Row Of Piers/Piles

Assuming A Uniform Distribution Of Load Horizontally Between

Individual Piers/Piles.

Janbus Empirical Coef is being used for the case of c & phi both > 0

A Critical Failure Surface Searching Method, Using A Random

Technique For Generating Sliding Block Surfaces, Has Been

Specified.

5000 Trial Surfaces Have Been Generated.

3 Boxes Specified For Generation Of Central Block Base

Length Of Line Segments For Active And Passive Portions Of

Sliding Block Is 80.0

Box No.	X-Left (ft)	Y-Left (ft)	X-Right (ft)	Y-Right (ft)	Height (ft)
1	262.10	125.00	266.10	125.00	5.00
2	310.00	150.00	314.00	150.00	5.00
3	383.00	199.00	387.00	199.00	5.00

The Factor Of Safety For The Trial Failure Surface Defined

By The Coordinates Listed Below Is Misleading.

Failure Surface Defined By 5 Coordinate Points

Point No.	X-Surf (ft)	Y-Surf (ft)
1	262.01	128.57

2 265.59 126.49
 3 312.13 149.29
 4 383.44 197.63
 5 383.48 211.00

Factor Of Safety For The Preceding Specified Surface = -3.735
 The Factor Of Safety For The Trial Failure Surface Defined
 By The Coordinates Listed Below Is Misleading.
 Failure Surface Defined By 5 Coordinate Points

Point No.	X-Surf (ft)	Y-Surf (ft)
1	262.01	128.57
2	265.59	126.49
3	312.13	149.29
4	383.44	197.63
5	383.48	211.00

Factor Of Safety For The Preceding Specified Surface = -3.735
 The Factor Of Safety For The Trial Failure Surface Defined
 By The Coordinates Listed Below Is Misleading.
 Failure Surface Defined By 5 Coordinate Points

Point No.	X-Surf (ft)	Y-Surf (ft)
1	262.01	128.57
2	265.59	126.49
3	312.13	149.29
4	383.44	197.63
5	383.48	211.00

Factor Of Safety For The Preceding Specified Surface = -3.735
 The Factor Of Safety For The Trial Failure Surface Defined
 By The Coordinates Listed Below Is Misleading.
 Failure Surface Defined By 5 Coordinate Points

Point No.	X-Surf (ft)	Y-Surf (ft)
1	262.01	128.57
2	265.59	126.49
3	312.13	149.29
4	383.44	197.63
5	383.48	211.00

Factor Of Safety For The Preceding Specified Surface = -3.735
 The Factor Of Safety For The Trial Failure Surface Defined
 By The Coordinates Listed Below Is Misleading.
 Failure Surface Defined By 5 Coordinate Points

Point No.	X-Surf (ft)	Y-Surf (ft)
1	262.01	128.57
2	265.59	126.49
3	312.13	149.29
4	383.44	197.63
5	383.48	211.00

Factor Of Safety For The Preceding Specified Surface = -3.735
 The Factor Of Safety For The Trial Failure Surface Defined
 By The Coordinates Listed Below Is Misleading.
 Failure Surface Defined By 5 Coordinate Points

Point No.	X-Surf (ft)	Y-Surf (ft)
1	262.01	128.57
2	265.59	126.49
3	312.13	149.29
4	383.44	197.63
5	383.48	211.00

Factor Of Safety For The Preceding Specified Surface = -3.735
 The Factor Of Safety For The Trial Failure Surface Defined
 By The Coordinates Listed Below Is Misleading.
 Failure Surface Defined By 5 Coordinate Points

Point No.	X-Surf (ft)	Y-Surf (ft)
1	262.01	128.57
2	265.59	126.49
3	312.13	149.29
4	383.44	197.63
5	383.48	211.00

Factor Of Safety For The Preceding Specified Surface = -3.735
 The Factor Of Safety For The Trial Failure Surface Defined
 By The Coordinates Listed Below Is Misleading.
 Failure Surface Defined By 5 Coordinate Points

Point No.	X-Surf (ft)	Y-Surf (ft)
1	262.01	128.57
2	265.59	126.49
3	312.13	149.29
4	383.44	197.63
5	383.48	211.00

Factor Of Safety For The Preceding Specified Surface = -3.735
 The Factor Of Safety For The Trial Failure Surface Defined
 By The Coordinates Listed Below Is Misleading.
 Failure Surface Defined By 5 Coordinate Points

Point No.	X-Surf (ft)	Y-Surf (ft)
1	262.01	128.57
2	265.59	126.49
3	312.13	149.29
4	383.44	197.63
5	383.48	211.00

Factor Of Safety For The Preceding Specified Surface = -3.735
 The Factor Of Safety For The Trial Failure Surface Defined
 By The Coordinates Listed Below Is Misleading.
 Failure Surface Defined By 5 Coordinate Points

Point No.	X-Surf (ft)	Y-Surf (ft)
1	262.01	128.57
2	265.59	126.49
3	312.13	149.29
4	383.44	197.63
5	383.48	211.00

Factor Of Safety For The Preceding Specified Surface = -3.735
 The Factor Of Safety For The Trial Failure Surface Defined
 By The Coordinates Listed Below Is Misleading.
 Failure Surface Defined By 5 Coordinate Points

Point No.	X-Surf (ft)	Y-Surf (ft)
1	262.01	128.57
2	265.59	126.49
3	312.13	149.29
4	383.44	197.63
5	383.48	211.00

Factor Of Safety For The Preceding Specified Surface = -3.735
 Following Are Displayed The Ten Most Critical Of The Trial
 Failure Surfaces Evaluated. They Are
 Ordered - Most Critical First.
 * * Safety Factors Are Calculated By The Simplified Janbu Method * *
 Total Number of Trial Surfaces Attempted = 5000
 Number of Trial Surfaces with Misleading FS = 10
 Number of Trial Surfaces With Valid FS = 4990
 Percentage of Trial Surfaces With Non-Valid FS Solutions
 of the Total Attempted = 0.2 %
 Statistical Data On All Valid FS Values:
 FS Max = 7.868 FS Min = 1.102 Tie FS Ave = 1.863
 Standard Deviation = 0.519 Coefficient of Variation = 27.85 %

Failure Surface Specified By 5 Coordinate Points

Point No.	X-Surf (ft)	Y-Surf (ft)
1	259.434	124.717
2	262.261	124.284
3	312.675	150.053
4	386.860	200.115
5	393.006	211.000

Factor of Safety
 *** 1.102 ***

Individual data on the 20 slices

Slice No.	Width (ft)	Weight (lbs)	Water Force		Tie Force Norm (lbs)	Tie Force Tan (lbs)	Earthquake Force		Surcharge Load (lbs)
			Top (lbs)	Bot (lbs)			Hor (lbs)	Ver (lbs)	
1	2.6	279.5	0.0	0.0	0.	0.	41.9	0.0	0.0
2	0.1	206.4	0.0	0.0	88.	3.	31.0	0.0	0.0
3	0.1	404.3	0.0	0.0	89.	3.	60.6	0.0	0.0
4	0.1	323.1	0.0	0.0	54.	2.	48.5	0.0	0.0
5	0.0	280.1	0.0	0.0	32.	0.	42.0	0.0	0.0
6	0.1	957.7	0.0	0.0	83.	0.	143.7	0.0	0.0
7	7.6	83685.8	0.0	0.0	7813.	0.	12552.9	0.0	0.0
8	0.1	1075.6	0.0	0.0	125.	0.	161.3	0.0	0.0
9	0.1	1074.9	0.0	0.0	126.	0.	161.2	0.0	0.0

10	9.8	102114.7	0.0	0.0	15493.	0.	15317.2	0.0	0.0
11	32.0	288994.5	0.0	0.0	93772.	1721.	43349.2	0.0	16000.0
12	0.7	5359.7	0.0	0.0	2135.	671.	804.0	0.0	337.3
13	1.3	10424.5	0.0	0.0	4638.	949.	1563.7	0.0	662.7
14	13.0	94075.2	0.0	0.0	43831.	15240.	14111.3	0.0	6500.0
15	26.0	143673.0	0.0	0.0	64760.	47563.	21550.9	0.0	13000.0
16	2.0	8595.4	0.0	0.0	3683.	3726.	1289.3	0.0	1000.0
17	30.0	86822.4	0.0	0.0	38619.	51343.	13023.4	0.0	15000.0
18	1.9	2783.8	0.0	0.0	1705.	2808.	417.6	0.0	930.1
19	0.0	58.0	0.0	0.0	102.	65.	8.7	0.0	20.6
20	6.1	4290.1	0.0	0.0	13957.	9768.	643.5	0.0	3052.3

Failure Surface Specified By 5 Coordinate Points

Point No.	X-Surf (ft)	Y-Surf (ft)
1	259.434	124.717
2	262.261	124.284
3	312.675	150.053
4	386.860	200.115
5	393.006	211.000

Factor of Safety
*** 1.102 ***

Failure Surface Specified By 5 Coordinate Points

Point No.	X-Surf (ft)	Y-Surf (ft)
1	259.434	124.717
2	262.261	124.284
3	312.675	150.053
4	386.860	200.115
5	393.006	211.000

Factor of Safety
*** 1.102 ***

Failure Surface Specified By 5 Coordinate Points

Point No.	X-Surf (ft)	Y-Surf (ft)
1	259.434	124.717
2	262.261	124.284
3	312.675	150.053
4	386.860	200.115
5	393.006	211.000

Factor of Safety
*** 1.102 ***

Failure Surface Specified By 5 Coordinate Points

Point No.	X-Surf (ft)	Y-Surf (ft)
1	259.434	124.717
2	262.261	124.284
3	312.675	150.053
4	386.860	200.115
5	393.006	211.000

Factor of Safety
*** 1.102 ***

Failure Surface Specified By 5 Coordinate Points

Point No.	X-Surf (ft)	Y-Surf (ft)
1	259.434	124.717
2	262.261	124.284
3	312.675	150.053
4	386.860	200.115
5	393.006	211.000

Factor of Safety
*** 1.102 ***

Failure Surface Specified By 5 Coordinate Points

Point No.	X-Surf (ft)	Y-Surf (ft)
1	259.434	124.717
2	262.261	124.284
3	312.675	150.053
4	386.860	200.115
5	393.006	211.000

Factor of Safety

*** 1.102 ***

Failure Surface Specified By 5 Coordinate Points

Point No.	X-Surf (ft)	Y-Surf (ft)
1	259.434	124.717
2	262.261	124.284
3	312.675	150.053
4	386.860	200.115
5	393.006	211.000

Factor of Safety
*** 1.102 ***

Failure Surface Specified By 5 Coordinate Points

Point No.	X-Surf (ft)	Y-Surf (ft)
1	259.434	124.717
2	262.261	124.284
3	312.675	150.053
4	386.860	200.115
5	393.006	211.000

Factor of Safety
*** 1.102 ***

Failure Surface Specified By 5 Coordinate Points

Point No.	X-Surf (ft)	Y-Surf (ft)
1	259.434	124.717
2	262.261	124.284
3	312.675	150.053
4	386.860	200.115
5	393.006	211.000

Factor of Safety
*** 1.102 ***

**** END OF GSTABL7 OUTPUT ****

A-A' / Existing Grade / Search Along Clay

z:\2010\10132-01 south shores church - dana point\engineering\2012_10\proposed design\aa'_cl.pl2 Run By: Username 10/23/2012 11:01AM

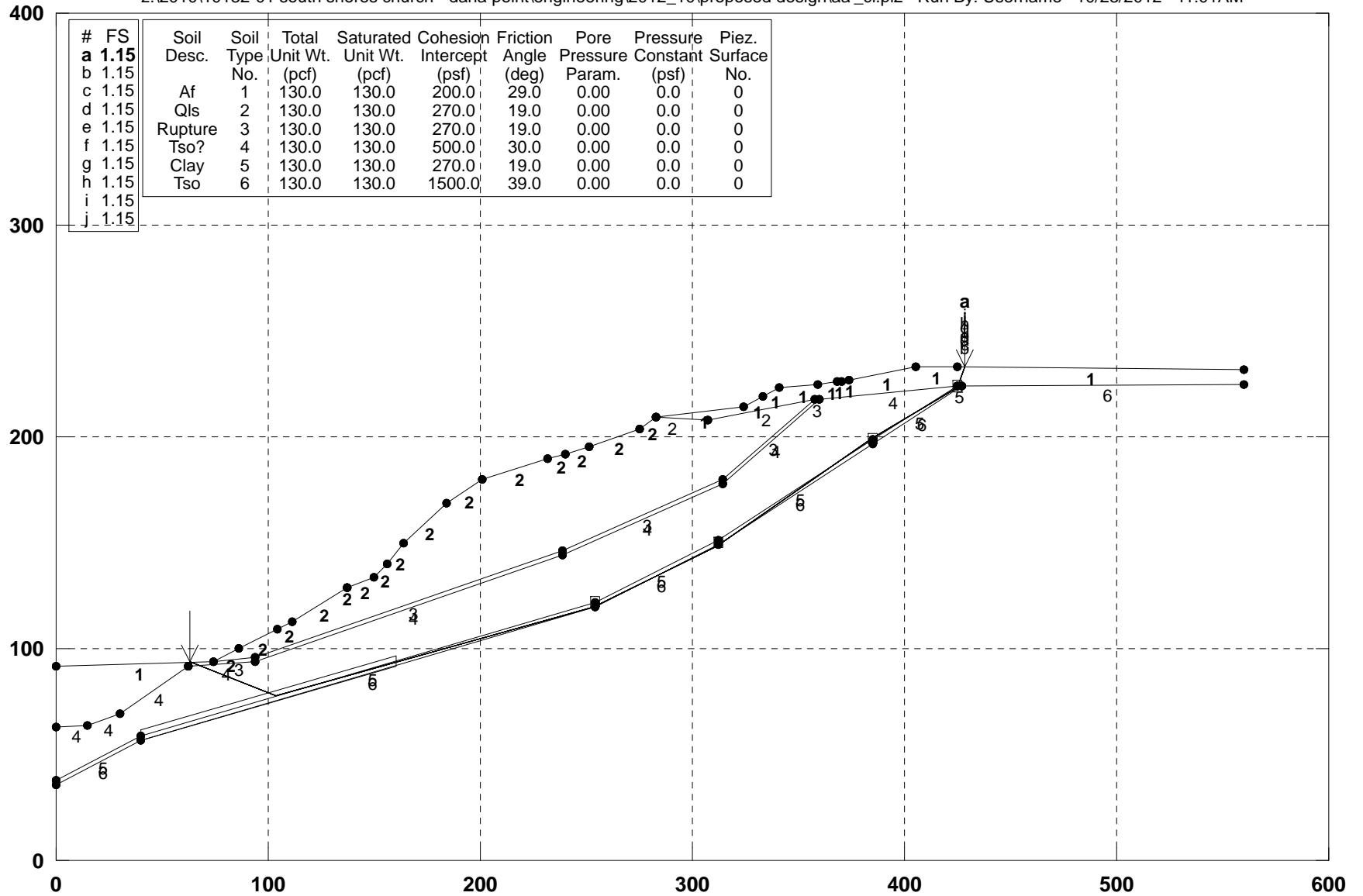

GSTABL7 v.2 FSmin=1.15

Safety Factors Are Calculated By The Simplified Janbu Method for the case of c & phi both > 0

*** GSTABL7 ***

** GSTABL7 by Dr. Garry H. Gregory, Ph.D., P.E., D.GE **

** Original Version 1.0, January 1996; Current Ver. 2.005.2, Jan. 2011 **
 (All Rights Reserved-Unauthorized Use Prohibited)

SLOPE STABILITY ANALYSIS SYSTEM

Modified Bishop, Simplified Janbu, or GLE Method of Slices.

(Includes Spencer & Morgenstern-Price Type Analysis)

Including Pier/Pile, Reinforcement, Soil Nail, Tieback,

Nonlinear Undrained Shear Strength, Curved Phi Envelope,

Anisotropic Soil, Fiber-Reinforced Soil, Boundary Loads, Water

Surfaces, Pseudo-Static & Newmark Earthquake, and Applied Forces.

Analysis Run Date: 10/23/2012

Time of Run: 11:01AM

Run By: Username

Input Data Filename: Z:\2010\10132-01 South Shores Church - Dana Point\Engineerin

g\2012_10\Proposed Design\aa'_cl Output Filename: Z:\2010\10132-01 South Shores Church - Dana Point\Engineerin

g\2012_10\Proposed Design\aa'_cl.OUTPUT Unit System: English

Plotted Output Filename: Z:\2010\10132-01 South Shores Church - Dana Point\Engineerin

g\2012_10\Proposed Design\aa'_cl.PLT

PROBLEM DESCRIPTION: A-A' / Existing Grade / Search Along

Clay

BOUNDARY COORDINATES

26 Top Boundaries

53 Total Boundaries

Boundary No.	X-Left (ft)	Y-Left (ft)	X-Right (ft)	Y-Right (ft)	Soil Type Below Bnd
1	0.00	92.00	74.00	94.00	1
2	74.00	94.00	86.00	100.00	2
3	86.00	100.00	104.00	109.00	2
4	104.00	109.00	111.00	113.00	2
5	111.00	113.00	137.00	129.00	2
6	137.00	129.00	137.00	129.00	2
7	137.00	129.00	150.00	134.00	2
8	150.00	134.00	156.00	140.00	2
9	156.00	140.00	164.00	150.00	2
10	164.00	150.00	184.00	169.00	2
11	184.00	169.00	201.00	180.00	2
12	201.00	180.00	232.00	190.00	2
13	232.00	190.00	240.00	192.00	2
14	240.00	192.00	251.00	195.00	2
15	251.00	195.00	275.00	204.00	2
16	275.00	204.00	283.00	209.00	2
17	283.00	209.00	324.00	214.00	1
18	324.00	214.00	333.00	219.00	1
19	333.00	219.00	341.00	223.00	1
20	341.00	223.00	359.00	225.00	1
21	359.00	225.00	368.00	226.00	1
22	368.00	226.00	370.00	226.00	1
23	370.00	226.00	374.00	227.00	1
24	374.00	227.00	405.00	233.00	1
25	405.00	233.00	425.00	233.00	1
26	425.00	233.00	560.00	232.00	1
27	283.00	209.00	307.00	208.00	2
28	307.00	208.00	358.00	218.00	2
29	358.00	218.00	360.00	218.00	3
30	360.00	218.00	425.00	224.00	4
31	425.00	224.00	427.00	224.00	5
32	427.00	224.00	560.00	225.00	6
33	0.00	63.00	15.00	64.00	4
34	15.00	64.00	30.00	69.00	4
35	30.00	69.00	62.00	92.00	4
36	74.00	94.00	94.00	96.00	3
37	94.00	96.00	239.00	146.00	3
38	239.00	146.00	314.00	180.00	3
39	314.00	180.00	358.00	218.00	3
40	62.00	92.00	94.00	94.00	4

41	94.00	94.00	239.00	144.00	4
42	239.00	144.00	314.00	178.00	4
43	314.00	178.00	360.00	218.00	4
44	0.00	38.00	40.00	59.00	5
45	40.00	59.00	254.00	122.00	5
46	254.00	122.00	312.00	151.00	5
47	312.00	151.00	385.00	199.00	5
48	385.00	199.00	425.00	224.00	5
49	0.00	36.00	40.00	57.00	6
50	40.00	57.00	254.00	120.00	6
51	254.00	120.00	312.00	149.00	6
52	312.00	149.00	385.00	197.00	6
53	385.00	197.00	427.00	224.00	6

Default Y-Origin = 0.00(ft)

Default X-Plus Value = 0.00(ft)

Default Y-Plus Value = 0.00(ft)

ISOTROPIC SOIL PARAMETERS

6 Type(s) of Soil

Soil Type No.	Total (pcf)	Saturated (pcf)	Cohesion (psf)	Friction Angle (deg)	Pore Pressure Param. (psf)	Pressure Constant	Piez. Surface
1	130.0	130.0	200.0	29.0	0.00	0.0	0
2	130.0	130.0	270.0	19.0	0.00	0.0	0
3	130.0	130.0	270.0	19.0	0.00	0.0	0
4	130.0	130.0	500.0	30.0	0.00	0.0	0
5	130.0	130.0	270.0	19.0	0.00	0.0	0
6	130.0	130.0	1500.0	39.0	0.00	0.0	0

Janbus Empirical Coef is being used for the case of c & phi both > 0

A Critical Failure Surface Searching Method, Using A Random

Technique For Generating Sliding Block Surfaces, Has Been

Specified.

5000 Trial Surfaces Have Been Generated.

5 Boxes Specified For Generation Of Central Block Base

Length Of Line Segments For Active And Passive Portions Of

Sliding Block Is 80.0

Box No.	X-Left (ft)	Y-Left (ft)	X-Right (ft)	Y-Right (ft)	Height (ft)
1	40.00	59.00	160.00	94.30	5.00
2	252.00	122.00	256.00	122.00	5.00
3	310.00	150.00	314.00	150.00	5.00
4	383.00	199.00	387.00	199.00	5.00
5	423.00	224.00	427.00	224.00	5.00

Following Are Displayed The Ten Most Critical Of The Trial

Failure Surfaces Evaluated. They Are

Ordered - Most Critical First.

* * Safety Factors Are Calculated By The Simplified Janbu Method * *

Total Number of Trial Surfaces Attempted = 5000

Number of Trial Surfaces With Valid FS = 5000

Statistical Data On All Valid FS Values:

FS Max = 2.535 FS Min = 1.151 FS Ave = 1.622

Standard Deviation = 0.250 Coefficient of Variation = 15.41 %

Failure Surface Specified By 7 Coordinate Points

Point No.	X-Surf (ft)	Y-Surf (ft)
1	62.693	93.694
2	103.889	77.821
3	253.393	119.983
4	311.329	148.733
5	384.811	199.244
6	424.716	223.236
7	428.390	232.975

Factor of Safety

*** 1.151 ***

Individual data on the 43 slices

Slice No.	Width (ft)	Weight (lbs)	Water Force		Tie Force Norm (lbs)	Tie Force Tan (lbs)	Earthquake Force (lbs)	Surcharge Ver (lbs)	Load (lbs)
			Top	Bot					
1	3.7	364.3	0.0	0.0	0.0	0.0	0.0	0.0	0.0
2	7.6	3062.2	0.0	0.0	0.0	0.0	0.0	0.0	0.0

3	12.0	15559.9	0.0	0.0	0.	0.	0.0	0.0	0.0
4	8.0	19580.7	0.0	0.0	0.	0.	0.0	0.0	0.0
5	9.9	34384.9	0.0	0.0	0.	0.	0.0	0.0	0.0
6	0.1	448.6	0.0	0.0	0.	0.	0.0	0.0	0.0
7	0.9	3530.2	0.0	0.0	0.	0.	0.0	0.0	0.0
8	6.1	25736.4	0.0	0.0	0.	0.	0.0	0.0	0.0
9	26.0	126776.4	0.0	0.0	0.	0.	0.0	0.0	0.0
10	13.0	71839.4	0.0	0.0	0.	0.	0.0	0.0	0.0
11	6.0	35356.9	0.0	0.0	0.	0.	0.0	0.0	0.0
12	8.0	53409.5	0.0	0.0	0.	0.	0.0	0.0	0.0
13	20.0	160958.3	0.0	0.0	0.	0.	0.0	0.0	0.0
14	17.0	158434.4	0.0	0.0	0.	0.	0.0	0.0	0.0
15	31.0	303948.2	0.0	0.0	0.	0.	0.0	0.0	0.0
16	7.0	69103.7	0.0	0.0	0.	0.	0.0	0.0	0.0
17	1.0	9855.3	0.0	0.0	0.	0.	0.0	0.0	0.0
18	11.0	108312.4	0.0	0.0	0.	0.	0.0	0.0	0.0
19	2.4	23584.7	0.0	0.0	0.	0.	0.0	0.0	0.0
20	0.6	5984.4	0.0	0.0	0.	0.	0.0	0.0	0.0
21	21.0	203570.4	0.0	0.0	0.	0.	0.0	0.0	0.0
22	8.0	76762.4	0.0	0.0	0.	0.	0.0	0.0	0.0
23	24.0	217881.2	0.0	0.0	0.	0.	0.0	0.0	0.0
24	4.3	36315.6	0.0	0.0	0.	0.	0.0	0.0	0.0
25	0.7	5543.1	0.0	0.0	0.	0.	0.0	0.0	0.0
26	2.0	16322.1	0.0	0.0	0.	0.	0.0	0.0	0.0
27	10.0	77199.9	0.0	0.0	0.	0.	0.0	0.0	0.0
28	9.0	65478.0	0.0	0.0	0.	0.	0.0	0.0	0.0
29	8.0	56806.1	0.0	0.0	0.	0.	0.0	0.0	0.0
30	17.0	108231.0	0.0	0.0	0.	0.	0.0	0.0	0.0
31	1.0	5692.3	0.0	0.0	0.	0.	0.0	0.0	0.0
32	1.0	5617.4	0.0	0.0	0.	0.	0.0	0.0	0.0
33	8.0	42241.9	0.0	0.0	0.	0.	0.0	0.0	0.0
34	2.0	9782.4	0.0	0.0	0.	0.	0.0	0.0	0.0
35	2.5	11774.2	0.0	0.0	0.	0.	0.0	0.0	0.0
36	1.5	6978.3	0.0	0.0	0.	0.	0.0	0.0	0.0
37	10.8	45703.2	0.0	0.0	0.	0.	0.0	0.0	0.0
38	15.2	52922.8	0.0	0.0	0.	0.	0.0	0.0	0.0
39	5.0	14615.3	0.0	0.0	0.	0.	0.0	0.0	0.0
40	19.7	40217.1	0.0	0.0	0.	0.	0.0	0.0	0.0
41	0.3	347.1	0.0	0.0	0.	0.	0.0	0.0	0.0
42	0.0	4.7	0.0	0.0	0.	0.	0.0	0.0	0.0
43	3.4	1980.9	0.0	0.0	0.	0.	0.0	0.0	0.0

Failure Surface Specified By 7 Coordinate Points

Point No.	X-Surf (ft)	Y-Surf (ft)
1	62.693	93.694
2	103.889	77.821
3	253.393	119.983
4	311.329	148.733
5	384.811	199.244
6	424.716	223.236
7	428.390	232.975

Factor of Safety
*** 1.151 ***

Failure Surface Specified By 7 Coordinate Points

Point No.	X-Surf (ft)	Y-Surf (ft)
1	62.693	93.694
2	103.889	77.821
3	253.393	119.983
4	311.329	148.733
5	384.811	199.244
6	424.716	223.236
7	428.390	232.975

Factor of Safety
*** 1.151 ***

Failure Surface Specified By 7 Coordinate Points

Point No.	X-Surf (ft)	Y-Surf (ft)
1	62.693	93.694
2	103.889	77.821

3	253.393	119.983
4	311.329	148.733
5	384.811	199.244
6	424.716	223.236
7	428.390	232.975

Factor of Safety
*** 1.151 ***

Failure Surface Specified By 7 Coordinate Points

Point No.	X-Surf (ft)	Y-Surf (ft)
1	62.693	93.694
2	103.889	77.821
3	253.393	119.983
4	311.329	148.733
5	384.811	199.244
6	424.716	223.236
7	428.390	232.975

Factor of Safety
*** 1.151 ***

Failure Surface Specified By 7 Coordinate Points

Point No.	X-Surf (ft)	Y-Surf (ft)
1	62.693	93.694
2	103.889	77.821
3	253.393	119.983
4	311.329	148.733
5	384.811	199.244
6	424.716	223.236
7	428.390	232.975

Factor of Safety
*** 1.151 ***

Failure Surface Specified By 7 Coordinate Points

Point No.	X-Surf (ft)	Y-Surf (ft)
1	62.693	93.694
2	103.889	77.821
3	253.393	119.983
4	311.329	148.733
5	384.811	199.244
6	424.716	223.236
7	428.390	232.975

Factor of Safety
*** 1.151 ***

Failure Surface Specified By 7 Coordinate Points

Point No.	X-Surf (ft)	Y-Surf (ft)
1	62.693	93.694
2	103.889	77.821
3	253.393	119.983
4	311.329	148.733
5	384.811	199.244
6	424.716	223.236
7	428.390	232.975

Factor of Safety
*** 1.151 ***

Failure Surface Specified By 7 Coordinate Points

Point No.	X-Surf (ft)	Y-Surf (ft)
1	62.693	93.694
2	103.889	77.821
3	253.393	119.983
4	311.329	148.733
5	384.811	199.244
6	424.716	223.236
7	428.390	232.975

Factor of Safety
*** 1.151 ***

Failure Surface Specified By 7 Coordinate Points

Point No.	X-Surf (ft)	Y-Surf (ft)
1	62.693	93.694
2	103.889	77.821

1	62.693	93.694
2	103.889	77.821
3	253.393	119.983
4	311.329	148.733
5	384.811	199.244
6	424.716	223.236
7	428.390	232.975

Factor of Safety
*** 1.151 ***
**** END OF GSTABL7 OUTPUT ****

A-A' / Existing Grade / Search Along Rupture

z:\2010\10132-01 south shores church - dana point\engineering\2012_10\proposed design\aa'.pl2 Run By: Username 10/22/2012 11:07AM

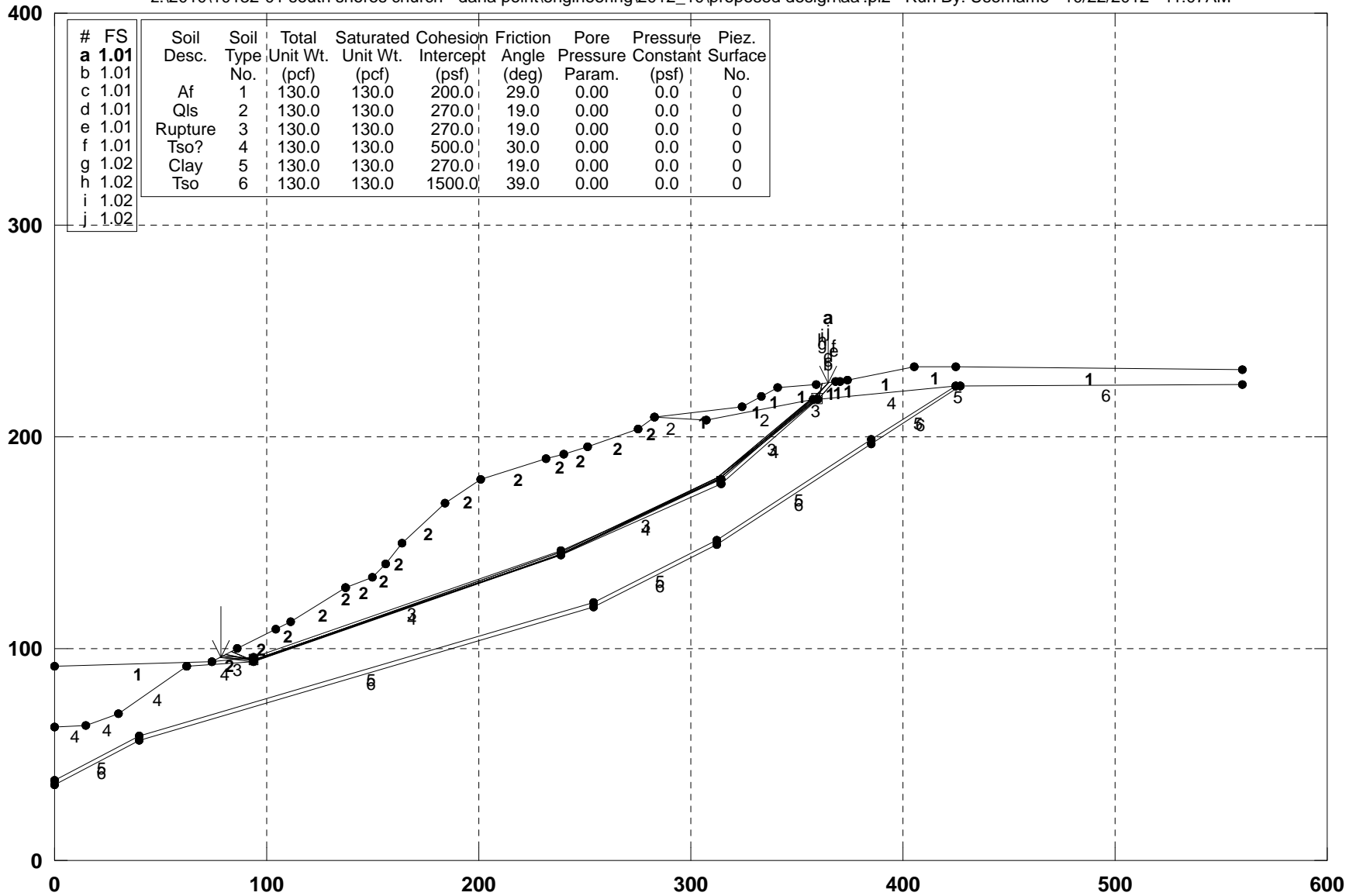

GSTABL7 v.2 FSmin=1.01

Safety Factors Are Calculated By The Simplified Janbu Method for the case of c & phi both > 0

*** GSTABL7 ***

** GSTABL7 by Dr. Garry H. Gregory, Ph.D.,P.E.,D.GE **

** Original Version 1.0, January 1996; Current Ver. 2.005.2, Jan. 2011 **
(All Rights Reserved-Unauthorizd Use Prohibited)

SLOPE STABILITY ANALYSIS SYSTEM

Modified Bishop, Simplified Janbu, or GLE Method of Slices.
(Includes Spencer & Morgenstern-Price Type Analysis)
Including Pier/Pile, Reinforcement, Soil Nail, Tieback,
Nonlinear Undrained Shear Strength, Curved Phi Envelope,
Anisotropic Soil, Fiber-Reinforced Soil, Boundary Loads, Water
Surfaces, Pseudo-Static & Newmark Earthquake, and Applied Forces.

Analysis Run Date: 10/22/2012
Time of Run: 11:07AM
Run By: Username
Input Data Filename: Z:\2010\10132-01 South Shores Church - Dana Point\Engineerin
g\2012_10\Proposed Design\aa'.
Output Filename: Z:\2010\10132-01 South Shores Church - Dana Point\Engineerin
g\2012_10\Proposed Design\aa'.OUT
Unit System: English
Plotted Output Filename: Z:\2010\10132-01 South Shores Church - Dana Point\Engineerin
g\2012_10\Proposed Design\aa'.PLT
PROBLEM DESCRIPTION: A-A' / Existing Grade / Search Along
Rupture

BOUNDARY COORDINATES

26 Top Boundaries
53 Total Boundaries

Boundary No.	X-Left (ft)	Y-Left (ft)	X-Right (ft)	Y-Right (ft)	Soil Type Below Bnd
1	0.00	92.00	74.00	94.00	1
2	74.00	94.00	86.00	100.00	2
3	86.00	100.00	104.00	109.00	2
4	104.00	109.00	111.00	113.00	2
5	111.00	113.00	137.00	129.00	2
6	137.00	129.00	137.00	129.00	2
7	137.00	129.00	150.00	134.00	2
8	150.00	134.00	156.00	140.00	2
9	156.00	140.00	164.00	150.00	2
10	164.00	150.00	184.00	169.00	2
11	184.00	169.00	201.00	180.00	2
12	201.00	180.00	232.00	190.00	2
13	232.00	190.00	240.00	192.00	2
14	240.00	192.00	251.00	195.00	2
15	251.00	195.00	275.00	204.00	2
16	275.00	204.00	283.00	209.00	2
17	283.00	209.00	324.00	214.00	1
18	324.00	214.00	333.00	219.00	1
19	333.00	219.00	341.00	223.00	1
20	341.00	223.00	359.00	225.00	1
21	359.00	225.00	368.00	226.00	1
22	368.00	226.00	370.00	226.00	1
23	370.00	226.00	374.00	227.00	1
24	374.00	227.00	405.00	233.00	1
25	405.00	233.00	425.00	233.00	1
26	425.00	233.00	560.00	232.00	1
27	283.00	209.00	307.00	208.00	2
28	307.00	208.00	358.00	218.00	2
29	358.00	218.00	360.00	218.00	3
30	360.00	218.00	425.00	224.00	4
31	425.00	224.00	427.00	224.00	5
32	427.00	224.00	560.00	225.00	6
33	0.00	63.00	15.00	64.00	4
34	15.00	64.00	30.00	69.00	4
35	30.00	69.00	62.00	92.00	4
36	74.00	94.00	94.00	96.00	3
37	94.00	96.00	239.00	146.00	3
38	239.00	146.00	314.00	180.00	3
39	314.00	180.00	358.00	218.00	3
40	62.00	92.00	94.00	94.00	4

41	94.00	94.00	239.00	144.00	4
42	239.00	144.00	314.00	178.00	4
43	314.00	178.00	360.00	218.00	4
44	0.00	38.00	40.00	59.00	5
45	40.00	59.00	254.00	122.00	5
46	254.00	122.00	312.00	151.00	5
47	312.00	151.00	385.00	199.00	5
48	385.00	199.00	425.00	224.00	5
49	0.00	36.00	40.00	57.00	6
50	40.00	57.00	254.00	120.00	6
51	254.00	120.00	312.00	149.00	6
52	312.00	149.00	385.00	197.00	6
53	385.00	197.00	427.00	224.00	6

Default Y-Origin = 0.00(ft)
Default X-Plus Value = 0.00(ft)
Default Y-Plus Value = 0.00(ft)

ISOTROPIC SOIL PARAMETERS

6 Type(s) of Soil

Soil Type No.	Total (pcf)	Saturated (pcf)	Cohesion (psf)	Friction (deg)	Pore Pressure Param. (psf)	Pressure Constant	Piez. Surface
1	130.0	130.0	200.0	29.0	0.00	0.0	0
2	130.0	130.0	270.0	19.0	0.00	0.0	0
3	130.0	130.0	270.0	19.0	0.00	0.0	0
4	130.0	130.0	500.0	30.0	0.00	0.0	0
5	130.0	130.0	270.0	19.0	0.00	0.0	0
6	130.0	130.0	1500.0	39.0	0.00	0.0	0

Janbus Empirical Coef is being used for the case of c & phi both > 0

A Critical Failure Surface Searching Method, Using A Random Technique For Generating Sliding Block Surfaces, Has Been Specified.

5000 Trial Surfaces Have Been Generated.

4 Boxes Specified For Generation Of Central Block Base
Length Of Line Segments For Active And Passive Portions Of Sliding Block Is 80.0

Box No.	X-Left (ft)	Y-Left (ft)	X-Right (ft)	Y-Right (ft)	Height (ft)
1	92.00	95.00	96.00	95.00	5.00
2	237.00	145.00	239.00	145.00	5.00
3	312.00	179.00	316.00	179.00	4.00
4	357.00	218.00	362.00	218.00	5.00

Following Are Displayed The Ten Most Critical Of The Trial

Failure Surfaces Evaluated. They Are

Ordered - Most Critical First.

* * Safety Factors Are Calculated By The Simplified Janbu Method * *

Total Number of Trial Surfaces Attempted = 5000

Number of Trial Surfaces With Valid FS = 5000

Statistical Data On All Valid FS Values:

FS Max = 1.743 FS Min = 1.012 FS Ave = 1.168

Standard Deviation = 0.161 Coefficient of Variation = 13.80 %

Failure Surface Specified By 6 Coordinate Points

Point No.	X-Surf (ft)	Y-Surf (ft)
1	78.185	96.092
2	95.085	94.375
3	237.213	144.226
4	312.565	180.121
5	357.470	218.119
6	364.645	225.627

Factor of Safety

*** 1.012 ***

Individual data on the 29 slices

Slice No.	Width (ft)	Weight (lbs)	Water Force Top (lbs)	Water Force Bot (lbs)	Tie Force Norm (lbs)	Tie Force Tan (lbs)	Earthquake Force (lbs)	Surcharge Ver Load (lbs)
1	7.8	2388.5	0.0	0.0	0.0	0.0	0.0	0.0
2	0.5	306.6	0.0	0.0	0.0	0.0	0.0	0.0
3	7.5	7086.2	0.0	0.0	0.0	0.0	0.0	0.0
4	1.1	1387.8	0.0	0.0	0.0	0.0	0.0	0.0

5	8.9	12555.3	0.0	0.0	0.	0.	0.0	0.0	0.0
6	7.0	11166.3	0.0	0.0	0.	0.	0.0	0.0	0.0
7	26.0	55713.8	0.0	0.0	0.	0.	0.0	0.0	0.0
8	13.0	34043.1	0.0	0.0	0.	0.	0.0	0.0	0.0
9	6.0	17403.1	0.0	0.0	0.	0.	0.0	0.0	0.0
10	8.0	28970.8	0.0	0.0	0.	0.	0.0	0.0	0.0
11	20.0	97359.7	0.0	0.0	0.	0.	0.0	0.0	0.0
12	17.0	101565.5	0.0	0.0	0.	0.	0.0	0.0	0.0
13	31.0	193598.5	0.0	0.0	0.	0.	0.0	0.0	0.0
14	5.2	32083.5	0.0	0.0	0.	0.	0.0	0.0	0.0
15	1.8	10888.0	0.0	0.0	0.	0.	0.0	0.0	0.0
16	1.0	6052.8	0.0	0.0	0.	0.	0.0	0.0	0.0
17	11.0	64817.2	0.0	0.0	0.	0.	0.0	0.0	0.0
18	24.0	134129.8	0.0	0.0	0.	0.	0.0	0.0	0.0
19	4.1	22305.0	0.0	0.0	0.	0.	0.0	0.0	0.0
20	3.9	21758.2	0.0	0.0	0.	0.	0.0	0.0	0.0
21	24.0	120775.2	0.0	0.0	0.	0.	0.0	0.0	0.0
22	5.6	24215.3	0.0	0.0	0.	0.	0.0	0.0	0.0
23	11.4	42133.8	0.0	0.0	0.	0.	0.0	0.0	0.0
24	9.0	26787.2	0.0	0.0	0.	0.	0.0	0.0	0.0
25	8.0	21010.3	0.0	0.0	0.	0.	0.0	0.0	0.0
26	16.1	27023.2	0.0	0.0	0.	0.	0.0	0.0	0.0
27	0.3	305.3	0.0	0.0	0.	0.	0.0	0.0	0.0
28	1.5	1192.7	0.0	0.0	0.	0.	0.0	0.0	0.0
29	5.6	1937.0	0.0	0.0	0.	0.	0.0	0.0	0.0

Failure Surface Specified By 6 Coordinate Points

Point No.	X-Surf (ft)	Y-Surf (ft)
1	78.185	96.092
2	95.085	94.375
3	237.213	144.226
4	312.565	180.121
5	357.470	218.119
6	364.645	225.627

Factor of Safety
*** 1.012 ***

Failure Surface Specified By 6 Coordinate Points

Point No.	X-Surf (ft)	Y-Surf (ft)
1	78.672	96.336
2	95.950	94.919
3	238.763	145.454
4	312.274	180.525
5	359.586	220.246
6	364.829	225.648

Factor of Safety
*** 1.013 ***

Failure Surface Specified By 6 Coordinate Points

Point No.	X-Surf (ft)	Y-Surf (ft)
1	78.672	96.336
2	95.950	94.919
3	238.763	145.454
4	312.274	180.525
5	359.586	220.246
6	364.829	225.648

Factor of Safety
*** 1.013 ***

Failure Surface Specified By 6 Coordinate Points

Point No.	X-Surf (ft)	Y-Surf (ft)
1	80.498	97.249
2	94.606	94.333
3	238.216	143.930
4	313.430	180.556
5	361.344	219.347
6	367.191	225.910

Factor of Safety
*** 1.014 ***

Failure Surface Specified By 6 Coordinate Points

Point No.	X-Surf (ft)	Y-Surf (ft)
1	80.498	97.249
2	94.606	94.333
3	238.216	143.930
4	313.430	180.556
5	361.344	219.347
6	367.191	225.910

Factor of Safety
*** 1.014 ***

Failure Surface Specified By 6 Coordinate Points

Point No.	X-Surf (ft)	Y-Surf (ft)
1	83.549	98.775
2	92.839	94.282
3	238.043	143.860
4	312.382	180.859
5	360.248	219.394
6	361.910	225.323

Factor of Safety
*** 1.017 ***

Failure Surface Specified By 6 Coordinate Points

Point No.	X-Surf (ft)	Y-Surf (ft)
1	83.549	98.775
2	92.839	94.282
3	238.043	143.860
4	312.382	180.859
5	360.248	219.394
6	361.910	225.323

Factor of Safety
*** 1.017 ***

Failure Surface Specified By 6 Coordinate Points

Point No.	X-Surf (ft)	Y-Surf (ft)
1	83.549	98.775
2	92.839	94.282
3	238.043	143.860
4	312.382	180.859
5	360.248	219.394
6	361.910	225.323

Factor of Safety
*** 1.017 ***

Failure Surface Specified By 6 Coordinate Points

Point No.	X-Surf (ft)	Y-Surf (ft)
1	77.764	95.882
2	92.718	93.720
3	238.436	144.275
4	312.323	179.222
5	359.433	218.949
6	364.954	225.662

Factor of Safety
*** 1.018 ***

**** END OF GSTABL7 OUTPUT ****

A-A' / Existing Grade / Search Along Rupture Infront of Caissons

z:\2010\10132-01 south shores church - dana point\engineering\2012_10\proposed design\aa'_4z.pl2 Run By: Username 10/25/2012 08:43AM

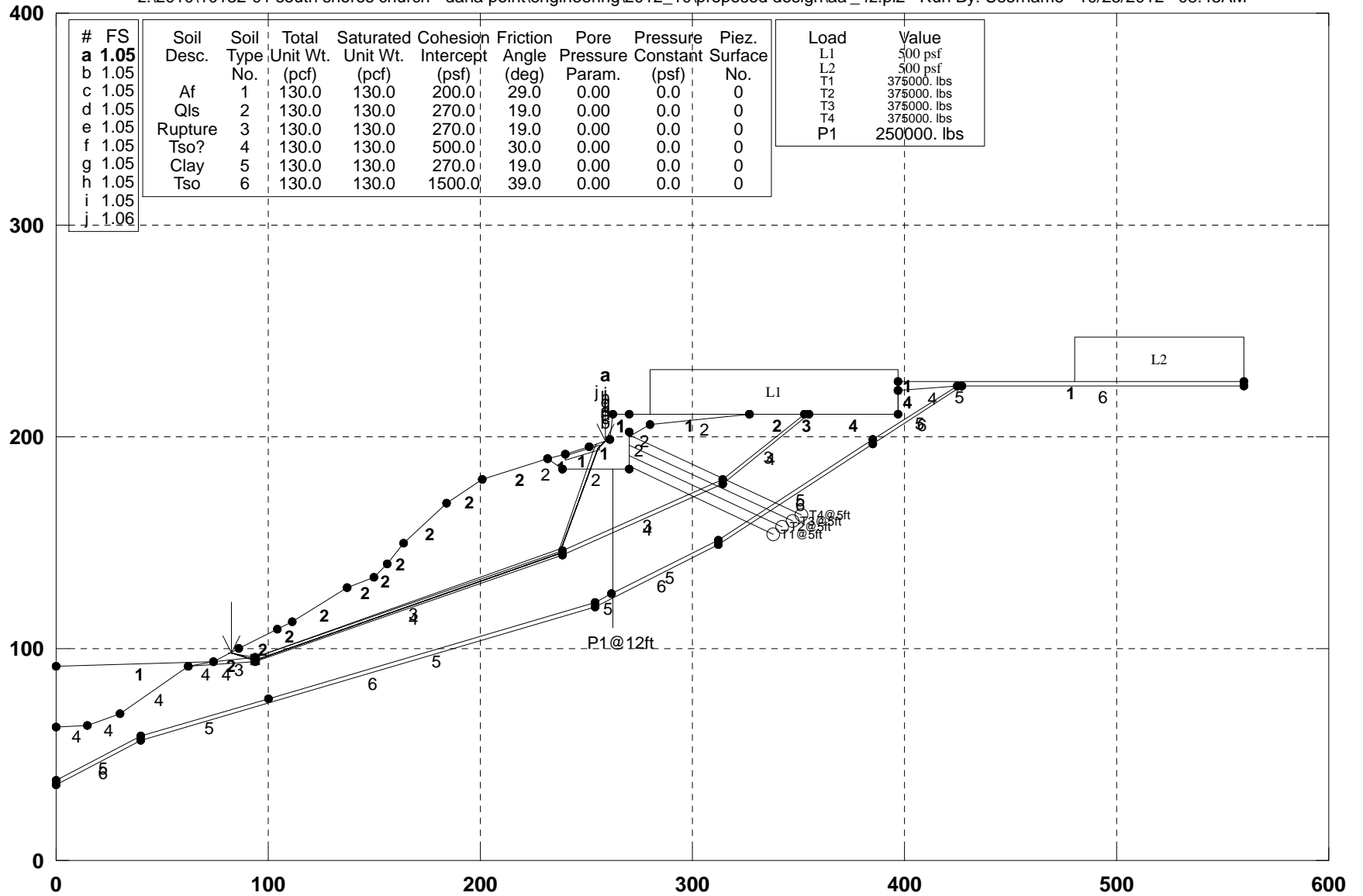

GSTABL7 v.2 FSmin=1.05

Safety Factors Are Calculated By The Simplified Janbu Method for the case of c & phi both > 0

*** GSTABL7 ***

** GSTABL7 by Dr. Garry H. Gregory, Ph.D., P.E., D.GE **

** Original Version 1.0, January 1996; Current Ver. 2.005.2, Jan. 2011 **
(All Rights Reserved-Unauthorizd Use Prohibited)

SLOPE STABILITY ANALYSIS SYSTEM

Modified Bishop, Simplified Janbu, or GLE Method of Slices.
(Includes Spencer & Morgenstern-Price Type Analysis)
Including Pier/Pile, Reinforcement, Soil Nail, Tieback,
Nonlinear Undrained Shear Strength, Curved Phi Envelope,
Anisotropic Soil, Fiber-Reinforced Soil, Boundary Loads, Water
Surfaces, Pseudo-Static & Newmark Earthquake, and Applied Forces.

Analysis Run Date: 10/25/2012
Time of Run: 08:43AM
Run By: Username
Input Data Filename: Z:\2010\10132-01 South Shores Church - Dana Point\Engineerin
g\2012_10\Proposed Design\aa'_4z.
Output Filename: Z:\2010\10132-01 South Shores Church - Dana Point\Engineerin
g\2012_10\Proposed Design\aa'_4z.OUT
Unit System: English
Plotted Output Filename: Z:\2010\10132-01 South Shores Church - Dana Point\Engineerin
g\2012_10\Proposed Design\aa'_4z.PLT
PROBLEM DESCRIPTION: A-A' / Existing Grade / Search Along
Rupture Infront of Caissons

BOUNDARY COORDINATES

23 Top Boundaries
55 Total Boundaries

Boundary No.	X-Left (ft)	Y-Left (ft)	X-Right (ft)	Y-Right (ft)	Soil Type Below Bnd
1	0.00	92.00	74.00	94.00	1
2	74.00	94.00	86.00	100.00	2
3	86.00	100.00	104.00	109.00	2
4	104.00	109.00	111.00	113.00	2
5	111.00	113.00	137.00	129.00	2
6	137.00	129.00	150.00	134.00	2
7	150.00	134.00	156.00	140.00	2
8	156.00	140.00	164.00	150.00	2
9	164.00	150.00	184.00	169.00	2
10	184.00	169.00	201.00	180.00	2
11	201.00	180.00	232.00	190.00	2
12	232.00	190.00	240.00	192.00	1
13	240.00	192.00	251.00	195.00	1
14	251.00	195.00	261.00	199.00	1
15	261.00	199.00	262.40	211.00	1
16	262.40	211.00	270.20	211.00	1
17	270.20	211.00	327.00	211.00	1
18	327.00	211.00	353.00	211.00	2
19	353.00	211.00	355.00	211.00	3
20	355.00	211.00	397.00	211.00	4
21	397.00	211.00	397.10	222.00	4
22	397.10	222.00	397.20	226.00	1
23	397.20	226.00	560.00	226.00	1
24	397.10	222.00	425.00	224.00	4
25	425.00	224.00	427.00	224.00	5
26	427.00	224.00	560.00	224.00	6
27	232.00	190.00	239.00	185.00	2
28	239.00	185.00	270.00	185.00	2
29	270.00	185.00	270.10	202.00	2
30	270.10	200.00	280.00	206.00	2
31	280.00	206.00	327.00	211.00	2
32	0.00	63.00	15.00	64.00	4
33	15.00	64.00	30.00	69.00	4
34	30.00	69.00	62.00	92.00	4
35	62.00	92.00	74.00	94.00	4
36	74.00	94.00	94.00	96.00	3
37	94.00	96.00	239.00	146.00	3
38	239.00	146.00	314.00	180.00	3
39	314.00	180.00	353.00	211.00	3
40	62.00	92.00	94.00	94.00	4

41	94.00	94.00	239.00	144.00	4
42	239.00	144.00	314.00	178.00	4
43	314.00	178.00	355.00	211.00	4
44	0.00	38.00	40.00	59.00	5
45	40.00	59.00	100.00	76.60	5
46	100.00	76.60	254.00	122.00	5
47	254.00	122.00	262.00	126.00	5
48	262.00	126.00	312.00	151.00	5
49	312.00	151.00	385.00	199.00	5
50	385.00	199.00	425.00	224.00	5
51	0.00	36.00	40.00	57.00	6
52	40.00	57.00	254.00	120.00	6
53	254.00	120.00	312.00	149.00	6
54	312.00	149.00	385.00	197.00	6
55	385.00	197.00	427.00	224.00	6

Default Y-Origin = 0.00(ft)
Default X-Plus Value = 0.00(ft)
Default Y-Plus Value = 0.00(ft)

ISOTROPIC SOIL PARAMETERS

6 Type(s) of Soil						
Soil No.	Total (pcf)	Saturated (pcf)	Cohesion (psf)	Friction Angle (deg)	Pore Pressure Param. (psf)	Piez. Constant Surface
1	130.0	130.0	200.0	29.0	0.00	0.0
2	130.0	130.0	270.0	19.0	0.00	0.0
3	130.0	130.0	270.0	19.0	0.00	0.0
4	130.0	130.0	500.0	30.0	0.00	0.0
5	130.0	130.0	270.0	19.0	0.00	0.0
6	130.0	130.0	1500.0	39.0	0.00	0.0

BOUNDARY LOAD(S)

2 Load(s) Specified

Load No.	X-Left (ft)	X-Right (ft)	Intensity (psf)	Deflection (deg)
1	280.00	397.00	500.0	0.0
2	480.00	560.00	500.0	0.0

NOTE - Intensity Is Specified As A Uniformly Distributed Force Acting On A Horizontally Projected Surface.

TIEBACK LOAD(S)

4 Tieback Load(s) Specified

Tieback No.	X-Pos (ft)	Y-Pos (ft)	Load (lbs)	Spacing (ft)	Inclination (deg)	Length (ft)	Force Method
1	270.01	186.00	375000.0	5.0	25.00	75.0	2
2	270.04	191.00	375000.0	5.0	25.00	80.0	2
3	270.06	196.00	375000.0	5.0	25.00	85.0	2
4	270.09	201.00	375000.0	5.0	25.00	90.0	2

NOTE - An Equivalent Line Load Is Calculated For Each Row Of Tiebacks Assuming A Uniform Distribution Of Load Horizontally Between Individual Tiebacks. Force Method 1 Considers Only Tangential Tieback Forces. Force Method 2 Considers Both Tangential and Normal Tieback Forces. Force Method 3 Considers Only Normal Tieback Forces. Force Method 4 Limits Normal and Tangential Tieback-Force Distribution to 1.5 Times the Tieback Inclination, or to 30 Degrees Below (Left of) the Tieback-Failure Surface Intersection, Whichever is Greater.

PIER/PILE LOAD(S)

1 Pier/Pile Load(s) Specified

Pier/Pile No.	X-Pos (ft)	Y-Pos (ft)	Load (lbs)	Spacing (ft)	Inclination (deg)	Length (ft)
1	262.40	185.00	250000.0	12.0	90.00	75.0

NOTE - An Equivalent Line Load Is Calculated For Each Row Of Piers/Piles Assuming A Uniform Distribution Of Load Horizontally Between Individual Piers/Piles.

Janbus Empirical Coef is being used for the case of c & phi both > 0
A Critical Failure Surface Searching Method, Using A Random Technique For Generating Sliding Block Surfaces, Has Been Specified.

5000 Trial Surfaces Have Been Generated.

3 Boxes Specified For Generation Of Central Block Base
Length Of Line Segments For Active And Passive Portions Of Sliding Block Is 80.0

Box	X-Left	Y-Left	X-Right	Y-Right	Height
-----	--------	--------	---------	---------	--------

No.	(ft)	(ft)	(ft)	(ft)	(ft)
1	92.00	95.00	96.00	95.00	5.00
2	237.00	145.00	239.00	145.00	5.00
3	240.00	190.00	256.00	195.00	2.00

Following Are Displayed The Ten Most Critical Of The Trial Failure Surfaces Evaluated. They Are Ordered - Most Critical First.

* * Safety Factors Are Calculated By The Simplified Janbu Method * *

Total Number of Trial Surfaces Attempted = 5000

Number of Trial Surfaces With Valid FS = 5000

Statistical Data On All Valid FS Values:

FS Max = 2.158 FS Min = 1.053 FS Ave = 1.302

Standard Deviation = 0.232 Coefficient of Variation = 17.78 %

Failure Surface Specified By 5 Coordinate Points

Point No.	X-Surf (ft)	Y-Surf (ft)
1	82.624	98.312
2	93.809	94.509
3	237.380	144.887
4	255.534	194.828
5	258.839	198.136

Factor of Safety
*** 1.053 ***

Individual data on the 21 slices

Slice No.	Width (ft)	Weight (lbs)	Water Force		Tie Force		Earthquake Force		Surcharge (lbs)	Hor Load (lbs)	Ver Load (lbs)
			Top (lbs)	Bot (lbs)	Norm (lbs)	Tan (lbs)	Hor (lbs)	Ver (lbs)			
1	3.4	622.4	0.0	0.0	0.0	0.0	0.0	0.0	0.0	0.0	
2	4.5	2733.6	0.0	0.0	0.0	0.0	0.0	0.0	0.0	0.0	
3	3.3	3475.2	0.0	0.0	0.0	0.0	0.0	0.0	0.0	0.0	
4	0.2	233.2	0.0	0.0	0.0	0.0	0.0	0.0	0.0	0.0	
5	10.0	13220.5	0.0	0.0	0.0	0.0	0.0	0.0	0.0	0.0	
6	7.0	10635.2	0.0	0.0	0.0	0.0	0.0	0.0	0.0	0.0	
7	26.0	53732.7	0.0	0.0	0.0	0.0	0.0	0.0	0.0	0.0	
8	13.0	33047.6	0.0	0.0	0.0	0.0	0.0	0.0	0.0	0.0	
9	6.0	16942.6	0.0	0.0	0.0	0.0	0.0	0.0	0.0	0.0	
10	8.0	28355.6	0.0	0.0	0.0	0.0	0.0	0.0	0.0	0.0	
11	20.0	95816.4	0.0	0.0	0.0	0.0	0.0	0.0	0.0	0.0	
12	17.0	100247.6	0.0	0.0	0.0	0.0	0.0	0.0	0.0	0.0	
13	31.0	191180.8	0.0	0.0	0.0	0.0	0.0	0.0	0.0	0.0	
14	5.4	32683.8	0.0	0.0	0.0	0.0	0.0	0.0	0.0	0.0	
15	0.2	1382.1	0.0	0.0	0.0	0.0	0.0	0.0	0.0	0.0	
16	1.4	7973.9	0.0	0.0	0.0	0.0	0.0	0.0	0.0	0.0	
17	1.0	5350.3	0.0	0.0	0.0	0.0	0.0	0.0	0.0	0.0	
18	11.0	37574.1	0.0	0.0	0.0	0.0	0.0	0.0	0.0	0.0	
19	1.0	1439.5	0.0	0.0	0.0	0.0	0.0	0.0	0.0	0.0	
20	3.6	2872.6	0.0	0.0	0.0	0.0	0.0	0.0	0.0	0.0	
21	3.3	426.6	0.0	0.0	0.0	0.0	0.0	0.0	0.0	0.0	

Failure Surface Specified By 5 Coordinate Points

Point No.	X-Surf (ft)	Y-Surf (ft)
1	82.624	98.312
2	93.809	94.509
3	237.380	144.887
4	255.534	194.828
5	258.839	198.136

Factor of Safety
*** 1.053 ***

Failure Surface Specified By 5 Coordinate Points

Point No.	X-Surf (ft)	Y-Surf (ft)
1	82.624	98.312
2	93.809	94.509
3	237.380	144.887
4	255.534	194.828
5	258.839	198.136

Factor of Safety
*** 1.053 ***

Failure Surface Specified By 5 Coordinate Points

Point No.	X-Surf (ft)	Y-Surf (ft)
1	82.624	98.312
2	93.809	94.509
3	237.380	144.887
4	255.534	194.828
5	258.839	198.136

Factor of Safety
*** 1.053 ***

Failure Surface Specified By 5 Coordinate Points

Point No.	X-Surf (ft)	Y-Surf (ft)
1	82.624	98.312
2	93.809	94.509
3	237.380	144.887
4	255.534	194.828
5	258.839	198.136

Factor of Safety
*** 1.053 ***

Failure Surface Specified By 5 Coordinate Points

Point No.	X-Surf (ft)	Y-Surf (ft)
1	82.624	98.312
2	93.809	94.509
3	237.380	144.887
4	255.534	194.828
5	258.839	198.136

Factor of Safety
*** 1.053 ***

Failure Surface Specified By 5 Coordinate Points

Point No.	X-Surf (ft)	Y-Surf (ft)
1	82.624	98.312
2	93.809	94.509
3	237.380	144.887
4	255.534	194.828
5	258.839	198.136

Factor of Safety
*** 1.053 ***

Failure Surface Specified By 5 Coordinate Points

Point No.	X-Surf (ft)	Y-Surf (ft)
1	82.624	98.312
2	93.809	94.509
3	237.380	144.887
4	255.534	194.828
5	258.839	198.136

Factor of Safety
*** 1.053 ***

Failure Surface Specified By 5 Coordinate Points

Point No.	X-Surf (ft)	Y-Surf (ft)
1	82.624	98.312
2	93.809	94.509
3	237.380	144.887
4	255.534	194.828
5	258.839	198.136

Factor of Safety
*** 1.053 ***

Failure Surface Specified By 5 Coordinate Points

Point No.	X-Surf (ft)	Y-Surf (ft)
1	81.379	97.689
2	94.012	95.935
3	237.044	147.094
4	253.347	193.840
5	255.140	196.656

Factor of Safety
*** 1.057 ***

**** END OF GSTABL7 OUTPUT ****

B-B' / Proposed / Search Along Clay / Caissons and Tiebacks

z:\2010\10132-01 south shores church - dana point\engineering\2013_05\proposed design\bb'1.pl2 Run By: Username 5/8/2013 02:04PM

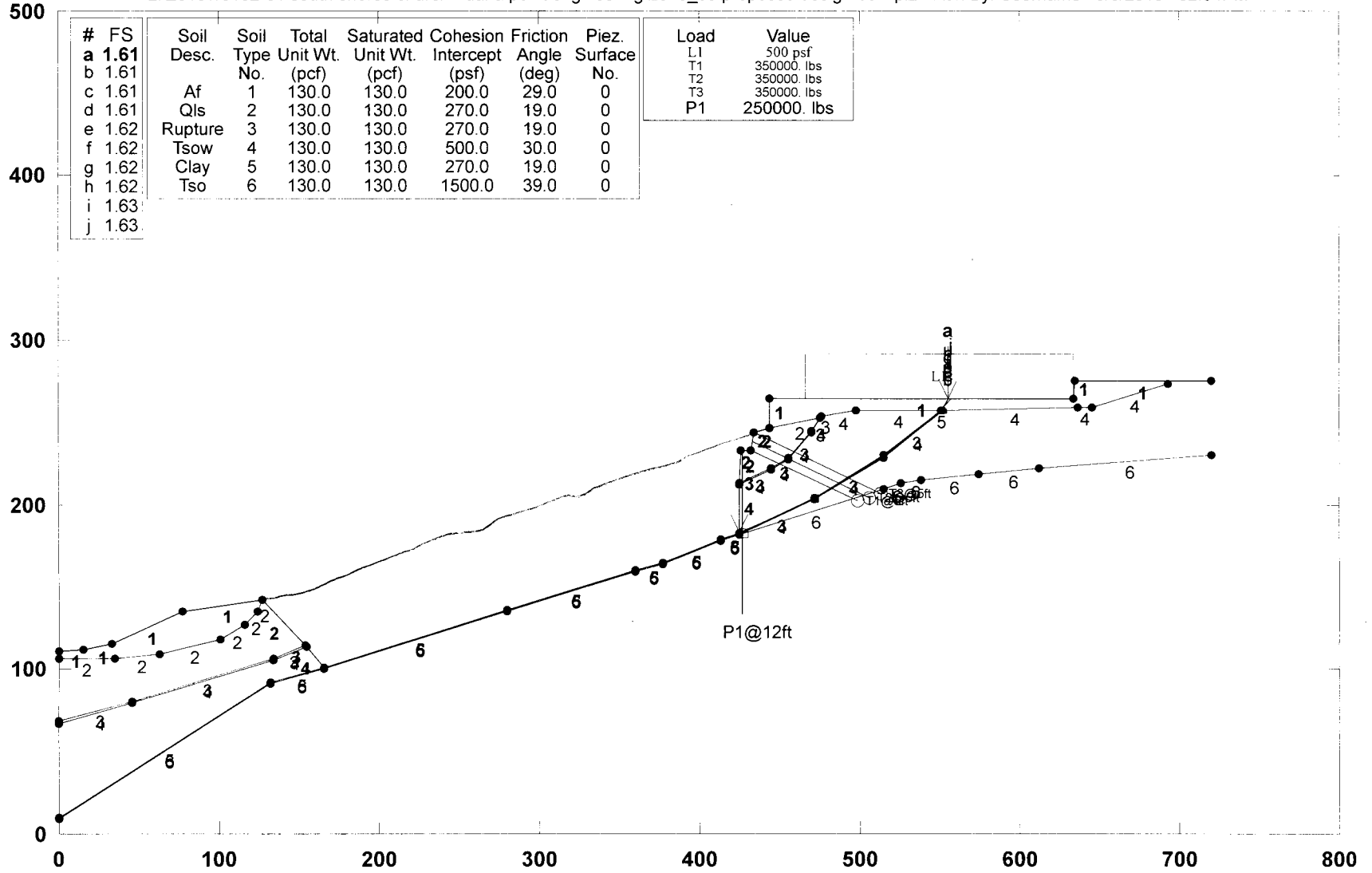

GSTABL7 v.2 FSmin=1.61

Safety Factors Are Calculated By The Simplified Janbu Method for the case of c & phi both > 0

*** GSTABL7 ***

** GSTABL7 by Dr. Garry H. Gregory, Ph.D., P.E., D.GE **

** Original Version 1.0, January 1996; Current Ver. 2.005.2, Jan. 2011 **
(All Rights Reserved-Unauthorizd Use Prohibited)

SLOPE STABILITY ANALYSIS SYSTEM

Modified Bishop, Simplified Janbu, or GLE Method of Slices.
(Includes Spencer & Morgenstern-Price Type Analysis)
Including Pier/Pile, Reinforcement, Soil Nail, Tieback,
Nonlinear Undrained Shear Strength, Curved Phi Envelope,
Anisotropic Soil, Fiber-Reinforced Soil, Boundary Loads, Water
Surfaces, Pseudo-Static & Newmark Earthquake, and Applied Forces.

Analysis Run Date: 10/24/2012
Time of Run: 03:28PM
Run By: Username
Input Data Filename: Z:\2010\10132-01 South Shores Church - Dana Point\Engineerin
g\2012_10\Proposed Design\bb'1.
Output Filename: Z:\2010\10132-01 South Shores Church - Dana Point\Engineerin
g\2012_10\Proposed Design\bb'1.OUT
Unit System: English
Plotted Output Filename: Z:\2010\10132-01 South Shores Church - Dana Point\Engineerin
g\2012_10\Proposed Design\bb'1.PLT
PROBLEM DESCRIPTION: B-B' / Alt Design / Search Along Clay /
Caissons and Tiebacks

BOUNDARY COORDINATES

22 Top Boundaries
72 Total Boundaries

Boundary No.	X-Left (ft)	Y-Left (ft)	X-Right (ft)	Y-Right (ft)	Soil Type Below Bnd
1	0.00	111.00	15.00	112.00	1
2	15.00	112.00	33.00	115.00	1
3	33.00	115.00	77.00	135.00	1
4	77.00	135.00	127.00	142.00	1
5	127.00	142.00	154.00	144.00	2
6	154.00	144.00	155.00	113.00	3
7	155.00	113.00	166.00	101.00	4
8	166.00	101.00	280.00	136.00	5
9	280.00	136.00	360.00	160.00	5
10	360.00	160.00	377.00	165.00	5
11	377.00	165.00	413.00	179.00	5
12	413.00	179.00	425.00	183.00	5
13	425.00	183.00	425.10	212.30	4
14	425.10	212.30	425.20	213.30	3
15	425.20	213.30	425.30	233.00	2
16	425.30	233.00	432.00	233.00	2
17	432.00	233.00	434.00	244.00	2
18	434.00	244.00	444.00	247.00	2
19	444.00	247.00	444.10	265.00	1
20	444.10	265.00	634.00	265.00	1
21	634.00	265.00	634.10	275.00	1
22	634.10	275.00	720.00	275.00	1
23	444.00	247.00	475.00	253.00	2
24	475.00	253.00	476.00	253.50	3
25	476.00	253.50	498.00	257.00	4
26	498.00	257.00	551.00	257.00	4
27	551.00	257.00	552.00	257.00	5
28	552.00	257.00	636.00	259.00	4
29	636.00	259.00	645.00	259.00	4
30	645.00	259.00	693.00	274.00	4
31	425.20	213.30	445.00	222.00	3
32	445.00	222.00	455.00	229.00	3
33	455.00	229.00	470.00	245.00	3
34	470.00	245.00	475.00	253.00	3
35	425.10	212.30	445.00	221.00	4
36	445.00	221.00	455.00	228.00	4
37	455.00	228.00	470.00	244.00	4
38	470.00	244.00	476.00	253.50	4
39	0.00	106.00	35.00	106.00	2
40	35.00	106.00	63.00	109.00	2

41	63.00	109.00	101.00	118.00	2
42	101.00	118.00	116.00	127.00	2
43	116.00	127.00	124.00	135.00	2
44	124.00	135.00	127.00	142.00	2
45	0.00	68.00	46.00	80.00	3
46	46.00	80.00	134.00	106.00	3
47	134.00	106.00	154.00	114.00	3
48	0.00	67.00	46.00	79.00	4
49	46.00	79.00	134.00	105.00	4
50	134.00	105.00	155.00	113.00	4
51	0.00	10.00	132.00	92.00	5
52	132.00	92.00	166.00	101.00	5
53	413.00	179.00	425.00	183.00	3
54	425.00	183.00	472.00	204.00	3
55	472.00	204.00	515.00	230.00	3
56	515.00	230.00	551.00	257.00	3
57	0.00	9.00	132.00	91.00	6
58	132.00	91.00	166.00	100.00	6
59	166.00	100.00	280.00	135.00	6
60	280.00	135.00	360.00	159.00	6
61	360.00	159.00	377.00	164.00	6
62	377.00	164.00	413.00	178.00	6
63	413.00	178.00	425.00	182.00	6
64	425.00	182.00	472.00	203.00	4
65	472.00	203.00	515.00	229.00	4
66	515.00	229.00	552.00	257.00	4
67	425.00	182.00	515.00	210.00	6
68	515.00	210.00	526.00	213.00	6
69	526.00	213.00	538.00	215.00	6
70	538.00	215.00	574.00	219.00	6
71	574.00	219.00	612.00	222.00	6
72	612.00	222.00	720.00	230.00	6

Default Y-Origin = 0.00(ft)
Default X-Plus Value = 0.00(ft)
Default Y-Plus Value = 0.00(ft)

ISOTROPIC SOIL PARAMETERS

6 Type(s) of Soil						
Soil Type No.	Total (pcf)	Saturated (pcf)	Cohesion (psf)	Friction Angle (deg)	Pore Pressure Param. (psf)	Piez. Constant Surface No.
1	130.0	130.0	200.0	29.0	0.00	0.0
2	130.0	130.0	270.0	19.0	0.00	0.0
3	130.0	130.0	270.0	19.0	0.00	0.0
4	130.0	130.0	500.0	30.0	0.00	0.0
5	130.0	130.0	270.0	19.0	0.00	0.0
6	130.0	130.0	1500.0	39.0	0.00	0.0

BOUNDARY LOAD(S)

1 Load(s) Specified				
Load No.	X-Left (ft)	X-Right (ft)	Intensity (psf)	Deflection (deg)
1	466.00	634.00	500.0	0.0

NOTE - Intensity Is Specified As A Uniformly Distributed Force Acting On A Horizontally Projected Surface.

TIEBACK LOAD(S)

3 Tieback Load(s) Specified							
Tieback No.	X-Pos (ft)	Y-Pos (ft)	Load (lbs)	Spacing (ft)	Inclination (deg)	Length (ft)	Force Method
1	432.09	233.50	350000.0	5.0	25.00	73.0	2
2	433.00	238.50	350000.0	5.0	25.00	80.0	2
3	433.91	243.50	350000.0	5.0	25.00	87.0	2

NOTE - An Equivalent Line Load Is Calculated For Each Row Of Tiebacks Assuming A Uniform Distribution Of Load Horizontally Between Individual Tiebacks. Force Method 1 Considers Only Tangential Tieback Forces. Force Method 2 Considers Both Tangential and Normal Tieback Forces. Force Method 3 Considers Only Normal Tieback Forces. Force Method 4 Limits Normal and Tangential Tieback-Force Distribution to 1.5 Times the Tieback Inclination, or to 30 Degrees Below (Left of) the Tieback-Failure Surface Intersection, Whichever is Greater.

PIER/PILE LOAD(S)

1 Pier/Pile Load(s) Specified

Pier/Pile No.	X-Pos (ft)	Y-Pos (ft)	Load (lbs)	Spacing (ft)	Inclination (deg)	Length (ft)
1	426.40	233.00	250000.0	12.0	90.00	100.0

NOTE - An Equivalent Line Load Is Calculated For Each Row Of Piers/Piles Assuming A Uniform Distribution Of Load Horizontally Between Individual Piers/Piles.

Janbus Empirical Coef is being used for the case of c & phi both > 0
 A Critical Failure Surface Searching Method, Using A Random Technique For Generating Sliding Block Surfaces, Has Been Specified.

8000 Trial Surfaces Have Been Generated.

4 Boxes Specified For Generation Of Central Block Base

Length Of Line Segments For Active And Passive Portions Of Sliding Block Is 60.0

Box No.	X-Left (ft)	Y-Left (ft)	X-Right (ft)	Y-Right (ft)	Height (ft)
1	425.10	182.50	430.00	182.50	5.00
2	470.00	204.00	474.00	204.00	5.00
3	513.00	230.00	517.00	230.00	5.00
4	550.00	257.00	554.00	257.00	2.00

The Factor Of Safety For The Trial Failure Surface Defined By The Coordinates Listed Below Is Misleading.

Failure Surface Defined By 6 Coordinate Points

Point No.	X-Surf (ft)	Y-Surf (ft)
1	425.01	186.17
2	429.57	183.52
3	473.49	205.49
4	515.13	229.29
5	550.44	256.45
6	550.47	265.00

Factor Of Safety For The Preceding Specified Surface = -4.730

The Factor Of Safety For The Trial Failure Surface Defined By The Coordinates Listed Below Is Misleading.

Failure Surface Defined By 6 Coordinate Points

Point No.	X-Surf (ft)	Y-Surf (ft)
1	425.01	185.37
2	428.99	181.41
3	471.32	202.59
4	516.13	229.81
5	550.48	257.21
6	550.49	265.00

Factor Of Safety For The Preceding Specified Surface = -0.949

The Factor Of Safety For The Trial Failure Surface Defined By The Coordinates Listed Below Is Misleading.

Failure Surface Defined By 6 Coordinate Points

Point No.	X-Surf (ft)	Y-Surf (ft)
1	425.01	184.92
2	427.74	182.81
3	472.76	202.86
4	516.79	231.13
5	553.12	256.04
6	553.14	265.00

Factor Of Safety For The Preceding Specified Surface = -3.040

The Factor Of Safety For The Trial Failure Surface Defined By The Coordinates Listed Below Is Misleading.

Failure Surface Defined By 6 Coordinate Points

Point No.	X-Surf (ft)	Y-Surf (ft)
1	425.00	182.95
2	425.92	182.11
3	472.04	205.22
4	514.46	227.97
5	551.80	257.63
6	551.81	265.00

Factor Of Safety For The Preceding Specified Surface = -2.106

WARNING! The factor of safety calculation did not converge in 20 iterations.
 The Trial Failure Surface In Question Is Defined

By The Following 6 Coordinate Points

Point No.	X-Surf (ft)	Y-Surf (ft)
1	425.01	184.76
2	426.49	184.22
3	470.21	203.13
4	513.46	232.45
5	551.76	256.87
6	551.79	265.00

Factor of Safety for the Preceding Surface is Between***** and*****

The Factor of Safety For The Trial Failure Surface Defined By The Coordinates Listed Below Is Misleading.

Failure Surface Defined By 6 Coordinate Points

Point No.	X-Surf (ft)	Y-Surf (ft)
1	425.01	186.17
2	429.57	183.52
3	473.49	205.49
4	515.13	229.29
5	550.44	256.45
6	550.47	265.00

Factor Of Safety For The Preceding Specified Surface = -4.730

The Factor of Safety For The Trial Failure Surface Defined By The Coordinates Listed Below Is Misleading.

Failure Surface Defined By 6 Coordinate Points

Point No.	X-Surf (ft)	Y-Surf (ft)
1	425.01	185.37
2	428.99	181.41
3	471.32	202.59
4	516.13	229.81
5	550.48	257.21
6	550.49	265.00

Factor Of Safety For The Preceding Specified Surface = -0.949

The Factor of Safety For The Trial Failure Surface Defined By The Coordinates Listed Below Is Misleading.

Failure Surface Defined By 6 Coordinate Points

Point No.	X-Surf (ft)	Y-Surf (ft)
1	425.01	184.92
2	427.74	182.81
3	472.76	202.86
4	516.79	231.13
5	553.12	256.04
6	553.14	265.00

Factor Of Safety For The Preceding Specified Surface = -3.040

The Factor of Safety For The Trial Failure Surface Defined By The Coordinates Listed Below Is Misleading.

Failure Surface Defined By 6 Coordinate Points

Point No.	X-Surf (ft)	Y-Surf (ft)
1	425.00	182.95
2	425.92	182.11
3	472.04	205.22
4	514.46	227.97
5	551.80	257.63
6	551.81	265.00

Factor Of Safety For The Preceding Specified Surface = -2.106

WARNING! The factor of safety calculation did not converge in 20 iterations.
 The Trial Failure Surface In Question Is Defined

By The Following 6 Coordinate Points

Point No.	X-Surf (ft)	Y-Surf (ft)
1	425.01	184.76
2	426.49	184.22
3	470.21	203.13
4	513.46	232.45
5	551.76	256.87
6	551.79	265.00

Factor of Safety for the Preceding Surface is Between***** and*****

The Factor Of Safety For The Trial Failure Surface Defined
By The Coordinates Listed Below Is Misleading.

Failure Surface Defined By 6 Coordinate Points

Point No.	X-Surf (ft)	Y-Surf (ft)
1	425.01	186.17
2	429.57	183.52
3	473.49	205.49
4	515.13	229.29
5	550.44	256.45
6	550.47	265.00

Factor Of Safety For The Preceding Specified Surface = -4.730

The Factor Of Safety For The Trial Failure Surface Defined

By The Coordinates Listed Below Is Misleading.

Failure Surface Defined By 6 Coordinate Points

Point No.	X-Surf (ft)	Y-Surf (ft)
1	425.01	185.37
2	428.99	181.41
3	471.32	202.59
4	516.13	229.81
5	550.48	257.21
6	550.49	265.00

Factor Of Safety For The Preceding Specified Surface = -0.949

The Factor Of Safety For The Trial Failure Surface Defined

By The Coordinates Listed Below Is Misleading.

Failure Surface Defined By 6 Coordinate Points

Point No.	X-Surf (ft)	Y-Surf (ft)
1	425.01	184.92
2	427.74	182.81
3	472.76	202.86
4	516.79	231.13
5	553.12	256.04
6	553.14	265.00

Factor Of Safety For The Preceding Specified Surface = -3.040

The Factor Of Safety For The Trial Failure Surface Defined

By The Coordinates Listed Below Is Misleading.

Failure Surface Defined By 6 Coordinate Points

Point No.	X-Surf (ft)	Y-Surf (ft)
1	425.00	182.95
2	425.92	182.11
3	472.04	205.22
4	514.46	227.97
5	551.80	257.63
6	551.81	265.00

Factor Of Safety For The Preceding Specified Surface = -2.106

WARNING! The factor of safety calculation did not converge in 20 iterations.

The Trial Failure Surface In Question Is Defined

By The Following 6 Coordinate Points

Point No.	X-Surf (ft)	Y-Surf (ft)
1	425.01	184.76
2	426.49	184.22
3	470.21	203.13
4	513.46	232.45
5	551.76	256.87
6	551.79	265.00

Factor of Safety for the Preceding Surface is Between***** and*****

The Factor Of Safety For The Trial Failure Surface Defined

By The Coordinates Listed Below Is Misleading.

Failure Surface Defined By 6 Coordinate Points

Point No.	X-Surf (ft)	Y-Surf (ft)
1	425.01	186.17
2	429.57	183.52
3	473.49	205.49
4	515.13	229.29
5	550.44	256.45

6	550.47	265.00
---	--------	--------

Factor Of Safety For The Preceding Specified Surface = -4.730

The Factor Of Safety For The Trial Failure Surface Defined

By The Coordinates Listed Below Is Misleading.

Failure Surface Defined By 6 Coordinate Points

Point No.	X-Surf (ft)	Y-Surf (ft)
1	425.01	185.37
2	428.99	181.41
3	471.32	202.59
4	516.13	229.81
5	550.48	257.21
6	550.49	265.00

Factor Of Safety For The Preceding Specified Surface = -0.949

The Factor Of Safety For The Trial Failure Surface Defined

By The Coordinates Listed Below Is Misleading.

Failure Surface Defined By 6 Coordinate Points

Point No.	X-Surf (ft)	Y-Surf (ft)
1	425.01	184.92
2	427.74	182.81
3	472.76	202.86
4	516.79	231.13
5	553.12	256.04
6	553.14	265.00

Factor Of Safety For The Preceding Specified Surface = -3.040

The Factor Of Safety For The Trial Failure Surface Defined

By The Coordinates Listed Below Is Misleading.

Failure Surface Defined By 6 Coordinate Points

Point No.	X-Surf (ft)	Y-Surf (ft)
1	425.00	182.95
2	425.92	182.11
3	472.04	205.22
4	514.46	227.97
5	551.80	257.63
6	551.81	265.00

Factor Of Safety For The Preceding Specified Surface = -2.106

WARNING! The factor of safety calculation did not converge in 20 iterations.

The Trial Failure Surface In Question Is Defined

By The Following 6 Coordinate Points

Point No.	X-Surf (ft)	Y-Surf (ft)
1	425.01	184.76
2	426.49	184.22
3	470.21	203.13
4	513.46	232.45
5	551.76	256.87
6	551.79	265.00

Factor of Safety for the Preceding Surface is Between***** and*****

Following Are Displayed The Ten Most Critical Of The Trial

Failure Surfaces Evaluated. They Are

Ordered - Most Critical First.

* * Safety Factors Are Calculated By The Simplified Janbu Method * *

Total Number of Trial Surfaces Attempted = 8000

WARNING! The Factor of Safety Calculation for one or More Trial Surfaces

Did Not Converge in 20 Iterations.

Number of Trial Surfaces with Non-Converged FS = 4

Number of Trial Surfaces with Misleading FS = 16

Number of Trial Failure Surfaces is Greater Than 5000.

Statistical Data on FS Values are Not Generated.

To Generate Stastical Data, Reduce Number of Trial

Failure Surfaces to 5000 or less.

Failure Surface Specified By 6 Coordinate Points

Point No.	X-Surf (ft)	Y-Surf (ft)
1	425.002	183.545
2	425.756	182.878
3	472.050	203.897
4	515.235	229.709

Slice No.	Width (ft)	Weight (lbs)	Water Force Top (lbs)	Water Force Bot (lbs)	Tie Force Norm (lbs)	Tie Force Tan (lbs)	Earthquake Force Hor (lbs)	Surcharge Force Ver (lbs)	Surcharge Load (lbs)
5		550.968			256.113				
6		555.103			265.000				
Factor of Safety									
*** 1.605 ***									
Individual data on the 26 slices									
1	0.1	184.0	0.0	0.0	71.0	47.0	0.0	0.0	0.0
2	0.1	382.0	0.0	0.0	73.0	48.0	0.0	0.0	0.0
3	0.1	517.6	0.0	0.0	73.0	48.0	0.0	0.0	0.0
4	0.1	716.7	0.0	0.0	82.0	54.0	0.0	0.0	0.0
5	0.3	2245.7	0.0	0.0	257.0	172.0	0.0	0.0	0.0
6	6.2	39531.4	0.0	0.0	4905.0	0.0	0.0	0.0	0.0
7	2.0	13606.6	0.0	0.0	2035.0	0.0	0.0	0.0	0.0
8	10.0	73591.4	0.0	0.0	13967.0	0.0	0.0	0.0	0.0
9	0.1	842.6	0.0	0.0	173.0	0.0	0.0	0.0	0.0
10	0.9	8609.8	0.0	0.0	1581.0	0.0	0.0	0.0	0.0
11	10.0	92448.6	0.0	0.0	20706.0	0.0	0.0	0.0	0.0
12	11.0	94876.0	0.0	0.0	26421.0	4954.0	0.0	0.0	0.0
13	4.0	32729.6	0.0	0.0	9496.0	3412.0	0.0	0.0	2000.0
14	2.0	16010.6	0.0	0.0	4625.0	1978.0	0.0	0.0	1000.0
15	0.0	393.8	0.0	0.0	113.0	51.0	0.0	0.0	24.8
16	3.0	23098.2	0.0	0.0	7378.0	2629.0	0.0	0.0	1475.2
17	1.0	7675.3	0.0	0.0	2449.0	984.0	0.0	0.0	500.0
18	22.0	149197.5	0.0	0.0	44250.0	29538.0	0.0	0.0	11000.0
19	17.0	89531.1	0.0	0.0	21289.0	23806.0	0.0	0.0	8500.0
20	0.2	1080.8	0.0	0.0	236.0	312.0	0.0	0.0	117.6
21	29.8	94083.2	0.0	0.0	24679.0	34830.0	0.0	0.0	14905.8
22	5.9	8524.2	0.0	0.0	3234.0	5841.0	0.0	0.0	2960.4
23	0.0	37.4	0.0	0.0	56.0	37.0	0.0	0.0	16.2
24	0.0	49.4	0.0	0.0	75.0	49.0	0.0	0.0	21.7
25	0.3	366.2	0.0	0.0	579.0	383.0	0.0	0.0	168.5
26	3.7	1935.8	0.0	0.0	5976.0	4249.0	0.0	0.0	1861.4
Failure Surface Specified By 6 Coordinate Points									
Point No.	X-Surf (ft)	Y-Surf (ft)							
1	425.002	183.545							
2	425.756	182.878							
3	472.050	203.897							
4	515.235	229.709							
5	550.968	256.113							
6	555.103	265.000							
Factor of Safety									
*** 1.605 ***									
Failure Surface Specified By 6 Coordinate Points									
Point No.	X-Surf (ft)	Y-Surf (ft)							
1	425.002	183.545							
2	425.756	182.878							
3	472.050	203.897							
4	515.235	229.709							
5	550.968	256.113							
6	555.103	265.000							
Factor of Safety									
*** 1.605 ***									
Failure Surface Specified By 6 Coordinate Points									
Point No.	X-Surf (ft)	Y-Surf (ft)							
1	425.002	183.545							
2	425.756	182.878							
3	472.050	203.897							
4	515.235	229.709							
5	550.968	256.113							
6	555.103	265.000							
Factor of Safety									
*** 1.605 ***									
Failure Surface Specified By 6 Coordinate Points									
Point No.	X-Surf (ft)	Y-Surf (ft)							
1	425.002	183.545							
2	425.756	182.878							
3	472.050	203.897							
4	515.235	229.709							
5	550.968	256.113							
6	555.103	265.000							
Factor of Safety									
*** 1.605 ***									

No.	(ft)	(ft)
1	425.002	183.684
2	425.465	183.225
3	471.530	203.424
4	513.184	228.103
5	552.135	257.892
6	555.094	265.000
Factor of Safety		
*** 1.617 ***		
Failure Surface Specified By 6 Coordinate Points		
Point No.	X-Surf (ft)	Y-Surf (ft)
1	425.002	183.684
2	425.465	183.225
3	471.530	203.424
4	513.184	228.103
5	552.135	257.892
6	555.094	265.000
Factor of Safety		
*** 1.617 ***		
Failure Surface Specified By 6 Coordinate Points		
Point No.	X-Surf (ft)	Y-Surf (ft)
1	425.002	183.684
2	425.465	183.225
3	471.530	203.424
4	513.184	228.103
5	552.135	257.892
6	555.094	265.000
Factor of Safety		
*** 1.617 ***		
Failure Surface Specified By 6 Coordinate Points		
Point No.	X-Surf (ft)	Y-Surf (ft)
1	425.002	183.684
2	425.465	183.225
3	471.530	203.424
4	513.184	228.103
5	552.135	257.892
6	555.094	265.000
Factor of Safety		
*** 1.617 ***		
Failure Surface Specified By 6 Coordinate Points		
Point No.	X-Surf (ft)	Y-Surf (ft)
1	425.001	183.170
2	425.594	182.907
3	471.104	203.223
4	516.977	230.207
5	550.897	257.531
6	556.976	265.000
Factor of Safety		
*** 1.630 ***		
Failure Surface Specified By 6 Coordinate Points		
Point No.	X-Surf (ft)	Y-Surf (ft)
1	425.001	183.170
2	425.594	182.907
3	471.104	203.223
4	516.977	230.207
5	550.897	257.531
6	556.976	265.000
Factor of Safety		
*** 1.630 ***		
**** END OF GSTABL7 OUTPUT ****		

B-B' / Proposed / Search Along Clay / Caissons and Tiebacks / Pseudostatic

z:\2010\10132-01 south shores church - dana point\engineering\2013_05\proposed design\bb'1p.pl2 Run By: Username 5/8/2013 02:05PM

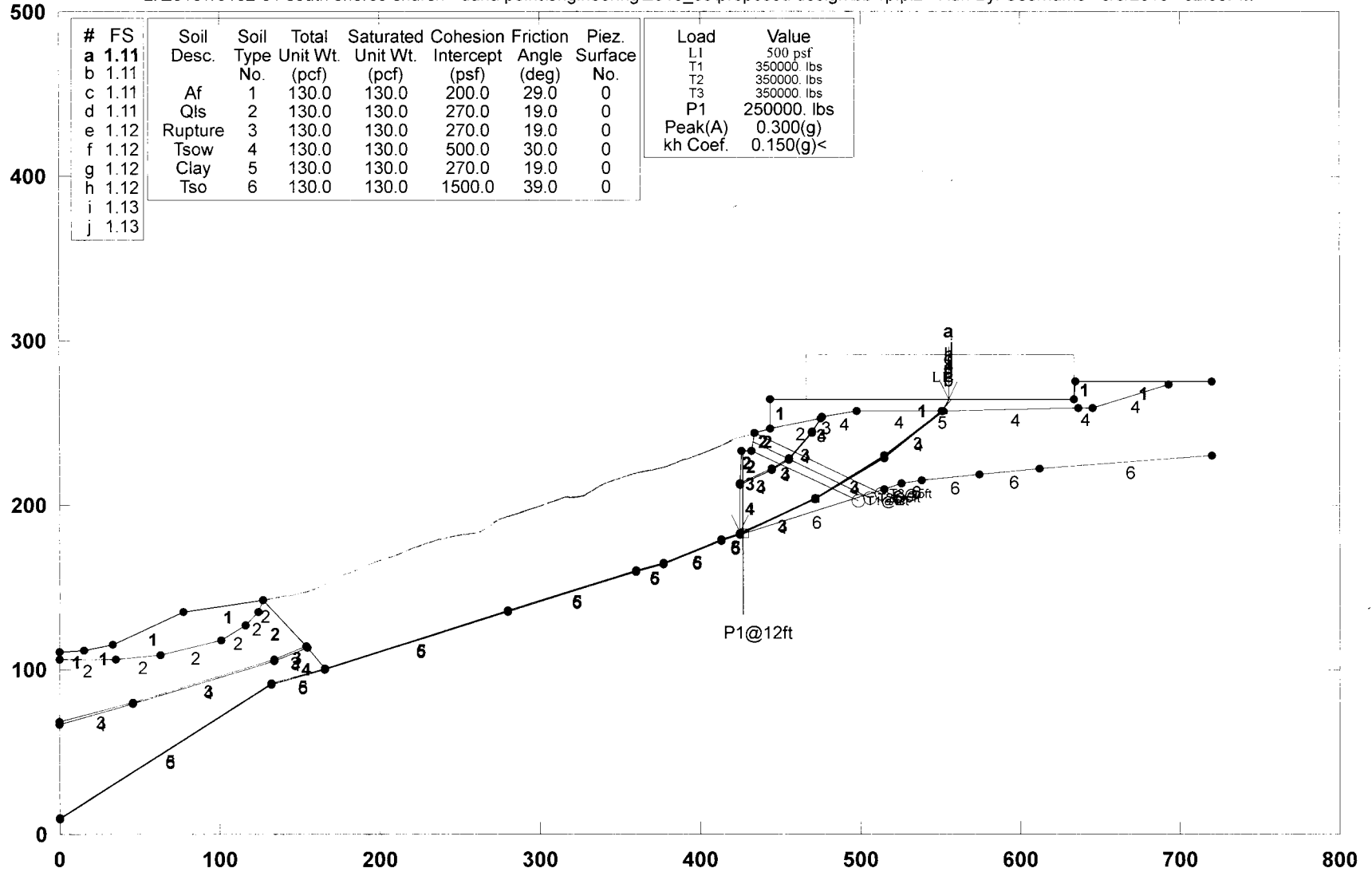

GSTABL7 v.2 FSmin=1.11

Safety Factors Are Calculated By The Simplified Janbu Method for the case of c & phi both > 0

*** GSTABL7 ***

** GSTABL7 by Dr. Garry H. Gregory, Ph.D.,P.E.,D.GE **

** Original Version 1.0, January 1996; Current Ver. 2.005.2, Jan. 2011 **
(All Rights Reserved-Unauthorizd Use Prohibited)

SLOPE STABILITY ANALYSIS SYSTEM

Modified Bishop, Simplified Janbu, or GLE Method of Slices.
(Includes Spencer & Morgenstern-Price Type Analysis)
Including Pier/Pile, Reinforcement, Soil Nail, Tieback,
Nonlinear Undrained Shear Strength, Curved Phi Envelope,
Anisotropic Soil, Fiber-Reinforced Soil, Boundary Loads, Water
Surfaces, Pseudo-Static & Newmark Earthquake, and Applied Forces.

Analysis Run Date: 10/24/2012
Time of Run: 10:03AM
Run By: Username
Input Data Filename: Z:\2010\10132-01 South Shores Church - Dana Point\Engineerin
g\2012_10\Proposed Design\bb'lp.
Output Filename: Z:\2010\10132-01 South Shores Church - Dana Point\Engineerin
g\2012_10\Proposed Design\bb'lp.OUT
Unit System: English
Plotted Output Filename: Z:\2010\10132-01 South Shores Church - Dana Point\Engineerin
g\2012_10\Proposed Design\bb'lp.PLT
PROBLEM DESCRIPTION: B-B' / Alt Design / Search Along Clay /
Caissons and Tiebacks / Pseudostatic

BOUNDARY COORDINATES

22 Top Boundaries
72 Total Boundaries

Boundary No.	X-Left (ft)	Y-Left (ft)	X-Right (ft)	Y-Right (ft)	Soil Type Below Bnd
1	0.00	111.00	15.00	112.00	1
2	15.00	112.00	33.00	115.00	1
3	33.00	115.00	77.00	135.00	1
4	77.00	135.00	127.00	142.00	1
5	127.00	142.00	154.00	144.00	2
6	154.00	144.00	155.00	113.00	3
7	155.00	113.00	166.00	101.00	4
8	166.00	101.00	280.00	136.00	5
9	280.00	136.00	360.00	160.00	5
10	360.00	160.00	377.00	165.00	5
11	377.00	165.00	413.00	179.00	5
12	413.00	179.00	425.00	183.00	5
13	425.00	183.00	425.10	212.30	4
14	425.10	212.30	425.20	213.30	3
15	425.20	213.30	425.30	233.00	2
16	425.30	233.00	432.00	233.00	2
17	432.00	233.00	434.00	244.00	2
18	434.00	244.00	444.00	247.00	2
19	444.00	247.00	444.10	265.00	1
20	444.10	265.00	634.00	265.00	1
21	634.00	265.00	634.10	275.00	1
22	634.10	275.00	720.00	275.00	1
23	444.00	247.00	475.00	253.00	2
24	475.00	253.00	476.00	253.50	3
25	476.00	253.50	498.00	257.00	4
26	498.00	257.00	551.00	257.00	4
27	551.00	257.00	552.00	257.00	5
28	552.00	257.00	636.00	259.00	4
29	636.00	259.00	645.00	259.00	4
30	645.00	259.00	693.00	274.00	4
31	425.20	213.30	445.00	222.00	3
32	445.00	222.00	455.00	229.00	3
33	455.00	229.00	470.00	245.00	3
34	470.00	245.00	475.00	253.00	3
35	425.10	212.30	445.00	221.00	4
36	445.00	221.00	455.00	228.00	4
37	455.00	228.00	470.00	244.00	4
38	470.00	244.00	476.00	253.50	4
39	0.00	106.00	35.00	106.00	2
40	35.00	106.00	63.00	109.00	2

41	63.00	109.00	101.00	118.00	2
42	101.00	118.00	116.00	127.00	2
43	116.00	127.00	124.00	135.00	2
44	124.00	135.00	127.00	142.00	2
45	0.00	68.00	46.00	80.00	3
46	46.00	80.00	134.00	106.00	3
47	134.00	106.00	154.00	114.00	3
48	0.00	67.00	46.00	79.00	4
49	46.00	79.00	134.00	105.00	4
50	134.00	105.00	155.00	113.00	4
51	0.00	10.00	132.00	92.00	5
52	132.00	92.00	166.00	101.00	5
53	413.00	179.00	425.00	183.00	3
54	425.00	183.00	472.00	204.00	3
55	472.00	204.00	515.00	230.00	3
56	515.00	230.00	551.00	257.00	3
57	0.00	9.00	132.00	91.00	6
58	132.00	91.00	166.00	100.00	6
59	166.00	100.00	280.00	135.00	6
60	280.00	135.00	360.00	159.00	6
61	360.00	159.00	377.00	164.00	6
62	377.00	164.00	413.00	178.00	6
63	413.00	178.00	425.00	182.00	6
64	425.00	182.00	472.00	203.00	4
65	472.00	203.00	515.00	229.00	4
66	515.00	229.00	552.00	257.00	4
67	425.00	182.00	515.00	210.00	6
68	515.00	210.00	526.00	213.00	6
69	526.00	213.00	538.00	215.00	6
70	538.00	215.00	574.00	219.00	6
71	574.00	219.00	612.00	222.00	6
72	612.00	222.00	720.00	230.00	6

Default Y-Origin = 0.00(ft)
Default X-Plus Value = 0.00(ft)
Default Y-Plus Value = 0.00(ft)

ISOTROPIC SOIL PARAMETERS

6 Type(s) of Soil

Soil Type No.	Total (pcf)	Saturated (pcf)	Cohesion (psf)	Friction Angle (deg)	Pore Pressure Param. (psf)	Pressure Constant	Piez. Surface
1	130.0	130.0	200.0	29.0	0.00	0.00	0
2	130.0	130.0	270.0	19.0	0.00	0.00	0
3	130.0	130.0	270.0	19.0	0.00	0.00	0
4	130.0	130.0	500.0	30.0	0.00	0.00	0
5	130.0	130.0	270.0	19.0	0.00	0.00	0
6	130.0	130.0	1500.0	39.0	0.00	0.00	0

BOUNDARY LOAD(S)

1 Load(s) Specified

Load No.	X-Left (ft)	X-Right (ft)	Intensity (psf)	Deflection (deg)
1	466.00	634.00	500.0	0.0

NOTE - Intensity Is Specified As A Uniformly Distributed

Force Acting On A Horizontally Projected Surface.

Specified Peak Ground Acceleration Coefficient (A) = 0.300(g)

Specified Horizontal Earthquake Coefficient (kh) = 0.150(g)

Specified Vertical Earthquake Coefficient (kv) = 0.000(g)

Specified Seismic Pore-Pressure Factor = 0.000

TIEBACK LOAD(S)

3 Tieback Load(s) Specified

Tieback No.	X-Pos (ft)	Y-Pos (ft)	Load (lbs)	Spacing (ft)	Inclination (deg)	Length (ft)	Force Method
1	432.09	233.50	350000.0	5.0	25.00	73.0	2
2	433.00	238.50	350000.0	5.0	25.00	80.0	2
3	433.91	243.50	350000.0	5.0	25.00	87.0	2

NOTE - An Equivalent Line Load Is Calculated For Each Row of Tiebacks

Assuming A Uniform Distribution Of Load Horizontally Between Individual

Tiebacks. Force Method 1 Considers Only Tangential Tieback Forces.

Force Method 2 Considers Both Tangential and Normal Tieback Forces.

Force Method 3 Considers Only Normal Tieback Forces.

Force Method 4 Limits Normal and Tangential Tieback-Force Distribution

to 1.5 Times the Tieback Inclination, or to 30 Degrees Below (Left of) the Tieback-Failure Surface Intersection, Whichever is Greater.

PIER/PILE LOAD(S)

1 Pier/Pile Load(s) Specified

Pier/Pile No.	X-Pos (ft)	Y-Pos (ft)	Load (lbs)	Spacing (ft)	Inclination (deg)	Length (ft)
1	426.40	233.00	250000.0	12.0	90.00	100.0

NOTE - An Equivalent Line Load Is Calculated For Each Row Of Piers/Piles Assuming A Uniform Distribution Of Load Horizontally Between Individual Piers/Piles.

Janbus Empirical Coef is being used for the case of c & phi both > 0 A Critical Failure Surface Searching Method, Using A Random Technique For Generating Sliding Block Surfaces, Has Been Specified.

8000 Trial Surfaces Have Been Generated.

4 Boxes Specified For Generation Of Central Block Base

Length Of Line Segments For Active And Passive Portions Of Sliding Block Is 60.0

Box No.	X-Left (ft)	Y-Left (ft)	X-Right (ft)	Y-Right (ft)	Height (ft)
1	425.10	182.50	430.00	182.50	5.00
2	470.00	204.00	474.00	204.00	5.00
3	513.00	230.00	517.00	230.00	5.00
4	550.00	257.00	554.00	257.00	2.00

WARNING! The factor of safety calculation did not converge in 20 iterations. The Trial Failure Surface In Question Is Defined

By The Following 6 Coordinate Points

Point No.	X-Surf (ft)	Y-Surf (ft)
1	425.01	186.17
2	429.57	183.52
3	473.49	205.49
4	515.13	229.29
5	550.44	256.45
6	550.47	265.00

Factor Of Safety for the Preceding Surface is Between***** and*****

The Factor Of Safety For The Trial Failure Surface Defined

By The Coordinates Listed Below Is Misleading.

Failure Surface Defined By 6 Coordinate Points

Point No.	X-Surf (ft)	Y-Surf (ft)
1	425.01	185.37
2	428.99	181.41
3	471.32	202.59
4	516.13	229.81
5	550.48	257.21
6	550.49	265.00

Factor Of Safety For The Preceding Specified Surface = -1.018

The Factor Of Safety For The Trial Failure Surface Defined

By The Coordinates Listed Below Is Misleading.

Failure Surface Defined By 6 Coordinate Points

Point No.	X-Surf (ft)	Y-Surf (ft)
1	425.01	184.92
2	427.74	182.81
3	472.76	202.86
4	516.79	231.13
5	553.12	256.04
6	553.14	265.00

Factor Of Safety For The Preceding Specified Surface = -4.958

The Factor Of Safety For The Trial Failure Surface Defined

By The Coordinates Listed Below Is Misleading.

Failure Surface Defined By 6 Coordinate Points

Point No.	X-Surf (ft)	Y-Surf (ft)
1	425.00	182.95
2	425.92	182.11
3	472.04	205.22
4	514.46	227.97
5	551.80	257.63

6	551.81	265.00
---	--------	--------

Factor Of Safety For The Preceding Specified Surface = -2.787

WARNING! The factor of safety calculation did not converge in 20 iterations.

The Trial Failure Surface In Question Is Defined

By The Following 6 Coordinate Points

Point No.	X-Surf (ft)	Y-Surf (ft)
1	425.01	186.17
2	429.57	183.52
3	473.49	205.49
4	515.13	229.29
5	550.44	256.45
6	550.47	265.00

Factor Of Safety for the Preceding Surface is Between***** and*****

The Factor Of Safety For The Trial Failure Surface Defined

By The Coordinates Listed Below Is Misleading.

Failure Surface Defined By 6 Coordinate Points

Point No.	X-Surf (ft)	Y-Surf (ft)
1	425.01	185.37
2	428.99	181.41
3	471.32	202.59
4	516.13	229.81
5	550.48	257.21
6	550.49	265.00

Factor Of Safety For The Preceding Specified Surface = -1.018

The Factor Of Safety For The Trial Failure Surface Defined

By The Coordinates Listed Below Is Misleading.

Failure Surface Defined By 6 Coordinate Points

Point No.	X-Surf (ft)	Y-Surf (ft)
1	425.01	184.92
2	427.74	182.81
3	472.76	202.86
4	516.79	231.13
5	553.12	256.04
6	553.14	265.00

Factor Of Safety For The Preceding Specified Surface = -4.958

The Factor Of Safety For The Trial Failure Surface Defined

By The Coordinates Listed Below Is Misleading.

Failure Surface Defined By 6 Coordinate Points

Point No.	X-Surf (ft)	Y-Surf (ft)
1	425.00	182.95
2	425.92	182.11
3	472.04	205.22
4	514.46	227.97
5	551.80	257.63
6	551.81	265.00

Factor Of Safety For The Preceding Specified Surface = -2.787

WARNING! The factor of safety calculation did not converge in 20 iterations.

The Trial Failure Surface In Question Is Defined

By The Following 6 Coordinate Points

Point No.	X-Surf (ft)	Y-Surf (ft)
1	425.01	186.17
2	429.57	183.52
3	473.49	205.49
4	515.13	229.29
5	550.44	256.45
6	550.47	265.00

Factor Of Safety for the Preceding Surface is Between***** and*****

The Factor Of Safety For The Trial Failure Surface Defined

By The Coordinates Listed Below Is Misleading.

Failure Surface Defined By 6 Coordinate Points

Point No.	X-Surf (ft)	Y-Surf (ft)
1	425.01	185.37
2	428.99	181.41
3	471.32	202.59

4 516.13 229.81
 5 550.48 257.21
 6 550.49 265.00

Factor Of Safety For The Preceding Specified Surface = -1.018
 The Factor Of Safety For The Trial Failure Surface Defined
 By The Coordinates Listed Below Is Misleading.

Failure Surface Defined By 6 Coordinate Points

Point No.	X-Surf (ft)	Y-Surf (ft)
1	425.01	184.92
2	427.74	182.81
3	472.76	202.86
4	516.79	231.13
5	553.12	256.04
6	553.14	265.00

Factor Of Safety For The Preceding Specified Surface = -4.958
 The Factor Of Safety For The Trial Failure Surface Defined
 By The Coordinates Listed Below Is Misleading.

Failure Surface Defined By 6 Coordinate Points

Point No.	X-Surf (ft)	Y-Surf (ft)
1	425.00	182.95
2	425.92	182.11
3	472.04	205.22
4	514.46	227.97
5	551.80	257.63
6	551.81	265.00

Factor Of Safety For The Preceding Specified Surface = -2.787
 WARNING! The factor of safety calculation did not converge in 20 iterations.
 The Trial Failure Surface In Question Is Defined

By The Following 6 Coordinate Points

Point No.	X-Surf (ft)	Y-Surf (ft)
1	425.01	186.17
2	429.57	183.52
3	473.49	205.49
4	515.13	229.29
5	550.44	256.45
6	550.47	265.00

Factor of Safety for the Preceding Surface is Between***** and*****

The Factor Of Safety For The Trial Failure Surface Defined
 By The Coordinates Listed Below Is Misleading.

Failure Surface Defined By 6 Coordinate Points

Point No.	X-Surf (ft)	Y-Surf (ft)
1	425.01	185.37
2	428.99	181.41
3	471.32	202.59
4	516.13	229.81
5	550.48	257.21
6	550.49	265.00

Factor Of Safety For The Preceding Specified Surface = -1.018
 The Factor Of Safety For The Trial Failure Surface Defined
 By The Coordinates Listed Below Is Misleading.

Failure Surface Defined By 6 Coordinate Points

Point No.	X-Surf (ft)	Y-Surf (ft)
1	425.01	184.92
2	427.74	182.81
3	472.76	202.86
4	516.79	231.13
5	553.12	256.04
6	553.14	265.00

Factor Of Safety For The Preceding Specified Surface = -4.958
 The Factor Of Safety For The Trial Failure Surface Defined
 By The Coordinates Listed Below Is Misleading.

Failure Surface Defined By 6 Coordinate Points

Point No.	X-Surf (ft)	Y-Surf (ft)
1	425.00	182.95

2 425.92 182.11
 3 472.04 205.22
 4 514.46 227.97
 5 551.80 257.63
 6 551.81 265.00

Factor Of Safety For The Preceding Specified Surface = -2.787
 Following Are Displayed The Ten Most Critical Of The Trial

Failure Surfaces Evaluated. They Are

Ordered - Most Critical First.

* * Safety Factors Are Calculated By The Simplified Janbu Method * *

Total Number of Trial Surfaces Attempted = 8000

WARNING! The Factor of Safety Calculation for one or More Trial Surfaces

Did Not Converge in 20 Iterations.

Number of Trial Surfaces with Non-Converged FS = 4

Number of Trial Surfaces with Misleading FS = 12

Number of Trial Failure Surfaces is Greater Than 5000.

Statistical Data on FS Values are Not Generated.

To Generate Stastical Data, Reduce Number of Trial

Failure Surfaces to 5000 or less.

Failure Surface Specified By 6 Coordinate Points

Point No.	X-Surf (ft)	Y-Surf (ft)
1	425.002	183.545
2	425.756	182.878
3	472.050	203.897
4	515.235	229.709
5	550.968	256.113
6	555.103	265.000

Factor of Safety

*** 1.113 ***

Individual data on the 26 slices

Slice No.	Width (ft)	Weight (lbs)	Water Force		Tie Force Norm (lbs)	Tie Force Tan (lbs)	Earthquake Force		Surcharge Load (lbs)
			Top (lbs)	Bot (lbs)			Hor (lbs)	Ver (lbs)	
1	0.1	184.0	0.0	0.0	71.47	47.27	27.6	0.0	0.0
2	0.1	382.0	0.0	0.0	73.48	48.57	57.3	0.0	0.0
3	0.1	517.6	0.0	0.0	73.48	48.77	67.6	0.0	0.0
4	0.1	716.7	0.0	0.0	82.54	54.10	107.5	0.0	0.0
5	0.3	2245.7	0.0	0.0	257.17	172.33	336.9	0.0	0.0
6	6.2	39531.4	0.0	0.0	4905.0	0.59	5929.7	0.0	0.0
7	2.0	13606.6	0.0	0.0	2035.0	0.20	2041.0	0.0	0.0
8	10.0	73591.4	0.0	0.0	13967.0	0.11	11038.7	0.0	0.0
9	0.1	842.6	0.0	0.0	173.0	0.12	126.4	0.0	0.0
10	0.9	8609.8	0.0	0.0	1581.0	0.12	1291.5	0.0	0.0
11	10.0	92448.6	0.0	0.0	20706.0	0.13	13867.3	0.0	0.0
12	11.0	94876.0	0.0	0.0	26421.0	0.14	14231.4	0.0	0.0
13	4.0	32729.6	0.0	0.0	9496.34	12.49	4909.4	0.0	2000.0
14	2.0	16010.6	0.0	0.0	4625.19	1978.24	2401.6	0.0	1000.0
15	0.0	393.8	0.0	0.0	113.51	59.1	59.1	0.0	24.8
16	3.0	23098.2	0.0	0.0	7378.26	2629.34	3464.7	0.0	1475.2
17	1.0	7675.3	0.0	0.0	2449.98	1151.3	0.0	0.0	500.0
18	22.0	149197.5	0.0	0.0	44250.29	538.23	2379.6	0.0	11000.0
19	17.0	89531.1	0.0	0.0	21289.23	806.13	13429.7	0.0	8500.0
20	0.2	1080.8	0.0	0.0	236.31	162.1	0.0	0.0	117.6
21	29.8	94083.2	0.0	0.0	24679.34	830.14	14112.5	0.0	14905.8
22	5.9	8524.2	0.0	0.0	3234.58	1278.6	0.0	0.0	2960.4
23	0.0	37.4	0.0	0.0	56.37	5.6	0.0	0.0	16.2
24	0.0	49.4	0.0	0.0	75.49	7.4	0.0	0.0	21.7
25	0.3	366.2	0.0	0.0	579.38	54.9	0.0	0.0	168.5
26	3.7	1935.8	0.0	0.0	5976.42	4249.29	290.4	0.0	1861.4

Failure Surface Specified By 6 Coordinate Points

Point No.	X-Surf (ft)	Y-Surf (ft)
1	425.002	183.545
2	425.756	182.878
3	472.050	203.897
4	515.235	229.709
5	550.968	256.113
6	555.103	265.000

Factor of Safety
 *** 1.113 ***
 Failure Surface Specified By 6 Coordinate Points

Point No.	X-Surf (ft)	Y-Surf (ft)
1	425.002	183.545
2	425.756	182.878
3	472.050	203.897
4	515.235	229.709
5	550.968	256.113
6	555.103	265.000

Factor of Safety
 *** 1.113 ***
 Failure Surface Specified By 6 Coordinate Points

Point No.	X-Surf (ft)	Y-Surf (ft)
1	425.002	183.545
2	425.756	182.878
3	472.050	203.897
4	515.235	229.709
5	550.968	256.113
6	555.103	265.000

Factor of Safety
 *** 1.113 ***
 Failure Surface Specified By 6 Coordinate Points

Point No.	X-Surf (ft)	Y-Surf (ft)
1	425.002	183.684
2	425.465	183.225
3	471.530	203.424
4	513.184	228.103
5	552.135	257.892
6	555.094	265.000

Factor of Safety
 *** 1.122 ***
 Failure Surface Specified By 6 Coordinate Points

Point No.	X-Surf (ft)	Y-Surf (ft)
1	425.002	183.684
2	425.465	183.225
3	471.530	203.424
4	513.184	228.103
5	552.135	257.892
6	555.094	265.000

Factor of Safety
 *** 1.122 ***
 Failure Surface Specified By 6 Coordinate Points

Point No.	X-Surf (ft)	Y-Surf (ft)
1	425.002	183.684
2	425.465	183.225
3	471.530	203.424
4	513.184	228.103
5	552.135	257.892
6	555.094	265.000

Factor of Safety
 *** 1.122 ***
 Failure Surface Specified By 6 Coordinate Points

Point No.	X-Surf (ft)	Y-Surf (ft)
1	425.002	183.684
2	425.465	183.225
3	471.530	203.424
4	513.184	228.103
5	552.135	257.892
6	555.094	265.000

Factor of Safety
 *** 1.122 ***
 Failure Surface Specified By 6 Coordinate Points

Point	X-Surf	Y-Surf
-------	--------	--------

No.	(ft)	(ft)
1	425.001	183.170
2	425.594	182.907
3	471.104	203.223
4	516.977	230.207
5	550.897	257.531
6	556.976	265.000

Factor of Safety
 *** 1.129 ***
 Failure Surface Specified By 6 Coordinate Points

Point No.	X-Surf (ft)	Y-Surf (ft)
1	425.001	183.170
2	425.594	182.907
3	471.104	203.223
4	516.977	230.207
5	550.897	257.531
6	556.976	265.000

Factor of Safety
 *** 1.129 ***
 **** END OF GSTABL7 OUTPUT ****

C-C' / Design / Search Along Clay / Caissons and Tiebacks

z:\2010\10132-01 south shores church - dana point\engineering\2012_10\proposed design\cc'_8.pl2 Run By: Username 10/24/2012 08:23AM

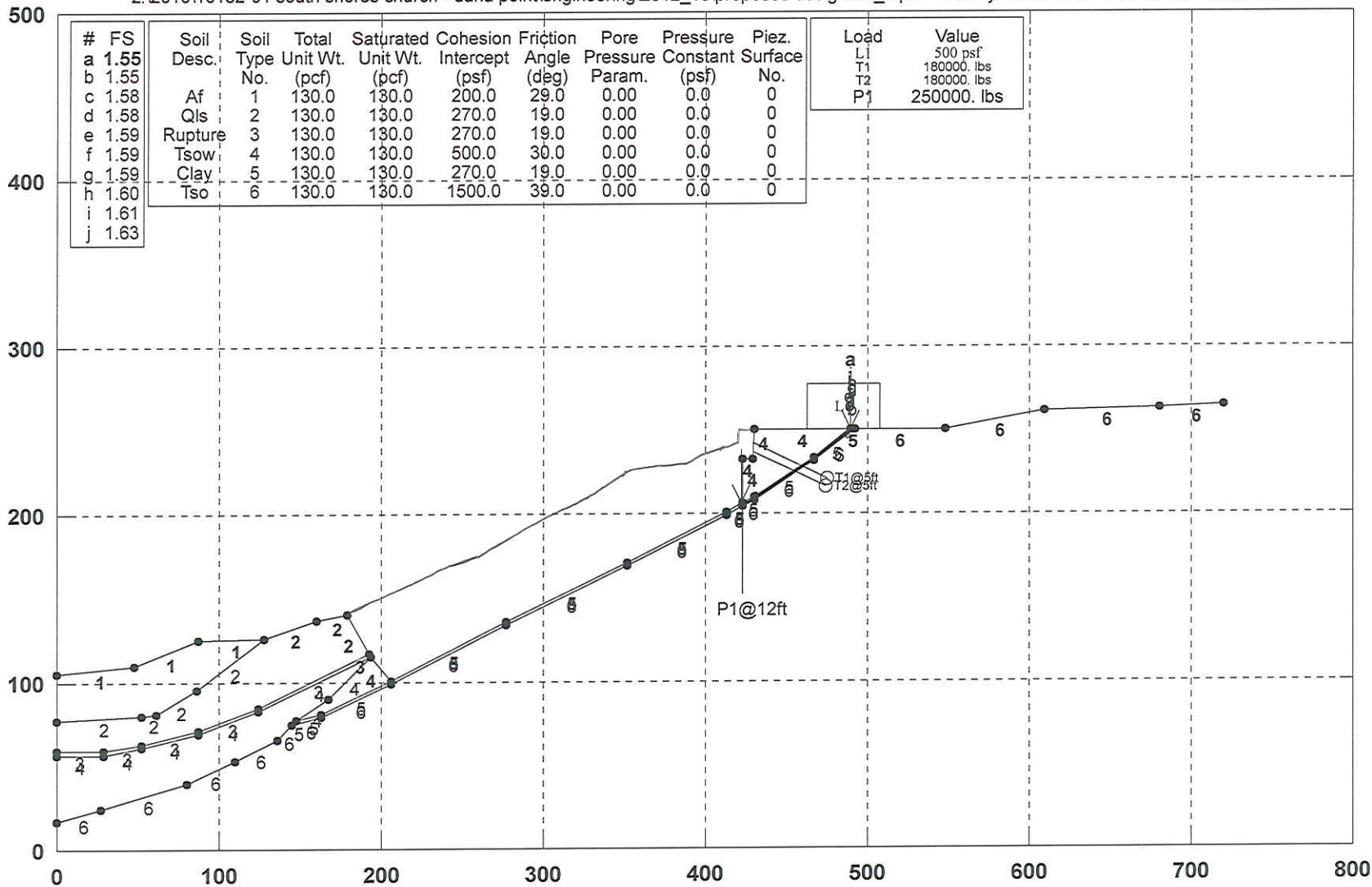

GSTABL7 v.2 FSmin=1.55

Safety Factors Are Calculated By The Simplified Janbu Method for the case of c & phi both > 0

*** GSTABL7 ***

** GSTABL7 by Dr. Garry H. Gregory, Ph.D., P.E., D.GE **

** Original Version 1.0, January 1996; Current Ver. 2.005.2, Jan. 2011 **
(All Rights Reserved-Unauthorizd Use Prohibited)

SLOPE STABILITY ANALYSIS SYSTEM

Modified Bishop, Simplified Janbu, or GLE Method of Slices.
(Includes Spencer & Morgenstern-Price Type Analysis)
Including Pier/Pile, Reinforcement, Soil Nail, Tieback,
Nonlinear Undrained Shear Strength, Curved Phi Envelope,
Anisotropic Soil, Fiber-Reinforced Soil, Boundary Loads, Water
Surfaces, Pseudo-Static & Newmark Earthquake, and Applied Forces.

Analysis Run Date: 10/24/2012
Time of Run: 08:23AM
Run By: Username
Input Data Filename: Z:\2010\10132-01 South Shores Church - Dana Point\Engineerin
g\2012_10\Proposed Design\cc'_8.
Output Filename: Z:\2010\10132-01 South Shores Church - Dana Point\Engineerin
g\2012_10\Proposed Design\cc'_8.OUT
Unit System: English
Plotted Output Filename: Z:\2010\10132-01 South Shores Church - Dana Point\Engineerin
g\2012_10\Proposed Design\cc'_8.PLT
PROBLEM DESCRIPTION: C-C' / Design / Search Along Clay /
Caissons and Tiebacks

BOUNDARY COORDINATES

Boundary No.	X-Left (ft)	Y-Left (ft)	X-Right (ft)	Y-Right (ft)	Soil Type Below Bnd
21 Top Boundaries					
57 Total Boundaries					
1	0.00	105.00	48.00	110.00	1
2	48.00	110.00	87.00	125.00	1
3	87.00	125.00	128.00	126.00	1
4	128.00	126.00	160.00	137.00	2
5	160.00	137.00	179.00	140.00	2
6	179.00	140.00	193.00	117.00	2
7	193.00	117.00	193.10	115.00	3
8	193.10	115.00	206.00	101.00	4
9	206.00	101.00	277.00	136.00	5
10	277.00	136.00	352.00	171.00	5
11	352.00	171.00	413.00	201.00	5
12	413.00	201.00	423.00	206.00	5
13	423.00	206.00	423.10	232.00	4
14	423.10	232.00	429.00	232.00	4
15	429.00	232.00	430.00	250.00	4
16	430.00	250.00	489.50	250.00	4
17	489.50	250.00	492.50	250.00	5
18	492.50	250.00	548.00	250.00	6
19	548.00	250.00	609.00	261.00	6
20	609.00	261.00	680.00	263.00	6
21	680.00	263.00	720.00	265.00	6
22	0.00	77.00	52.00	80.00	2
23	52.00	80.00	61.00	81.00	2
24	61.00	81.00	86.00	95.00	2
25	86.00	95.00	128.00	126.00	2
26	0.00	59.00	29.00	59.00	3
27	29.00	59.00	52.00	63.00	3
28	52.00	63.00	87.00	71.00	3
29	87.00	71.00	124.00	85.00	3
30	124.00	85.00	193.00	117.00	3
31	0.00	57.00	29.00	57.00	4
32	29.00	57.00	52.00	61.00	4
33	52.00	61.00	87.00	69.00	4
34	87.00	69.00	124.00	83.00	4
35	124.00	83.00	193.10	115.00	4
36	0.00	17.00	27.00	24.00	6
37	27.00	24.00	80.00	40.00	6
38	80.00	40.00	110.00	53.00	6
39	110.00	53.00	136.00	66.00	6
40	136.00	66.00	145.00	75.00	6

41	145.00	75.00	148.00	77.00	5
42	148.00	77.00	167.00	90.00	4
43	167.00	90.00	193.10	115.00	4
44	148.00	77.00	163.00	81.00	5
45	163.00	81.00	206.00	101.00	5
46	423.00	206.00	430.00	210.00	5
47	430.00	210.00	467.00	233.00	5
48	467.00	233.00	489.50	250.00	5
49	145.00	75.00	163.00	79.00	6
50	163.00	79.00	206.00	99.00	6
51	206.00	99.00	277.00	134.00	6
52	277.00	134.00	352.00	169.00	6
53	352.00	169.00	413.00	199.00	6
54	413.00	199.00	423.00	204.00	6
55	423.00	204.00	430.00	208.00	6
56	430.00	208.00	467.00	231.00	6
57	467.00	231.00	492.50	250.00	6

Default Y-Origin = 0.00(ft)
Default X-Plus Value = 0.00(ft)
Default Y-Plus Value = 0.00(ft)

ISOTROPIC SOIL PARAMETERS

Soil No.	Total (pcf)	Saturated (pcf)	Cohesion (psf)	Friction (deg)	Pore Pressure Param. (psf)	Pressure Constant	Piez. Surface
6 Type(s) of Soil							
1	130.0	130.0	200.0	29.0	0.00	0.0	0
2	130.0	130.0	270.0	19.0	0.00	0.0	0
3	130.0	130.0	270.0	19.0	0.00	0.0	0
4	130.0	130.0	500.0	30.0	0.00	0.0	0
5	130.0	130.0	270.0	19.0	0.00	0.0	0
6	130.0	130.0	1500.0	39.0	0.00	0.0	0

BOUNDARY LOAD(S)

Load No.	X-Left (ft)	X-Right (ft)	Intensity (psf)	Deflection (deg)
1	463.00	508.00	500.0	0.0

NOTE - Intensity Is Specified As A Uniformly Distributed Force Acting On A Horizontally Projected Surface.

TIEBACK LOAD(S)

Tieback No.	X-Pos (ft)	Y-Pos (ft)	Load (lbs)	Spacing (ft)	Inclination (deg)	Length (ft)	Force Method
2 Tieback Load(s) Specified							
1	429.56	242.00	180000.0	5.0	25.00	50.0	2
2	429.28	237.00	180000.0	5.0	25.00	50.0	2

NOTE - An Equivalent Line Load Is Calculated For Each Row Of Tiebacks Assuming A Uniform Distribution Of Load Horizontally Between Individual Tiebacks. Force Method 1 Considers Only Tangential Tieback Forces. Force Method 2 Considers Both Tangential and Normal Tieback Forces. Force Method 3 Considers Only Normal Tieback Forces. Force Method 4 Limits Normal and Tangential Tieback-Force Distribution to 1.5 Times the Tieback Inclination, or to 30 Degrees Below (Left of) the Tieback-Failure Surface Intersection, Whichever is Greater.

PIER/PILE LOAD(S)

Pier/Pile No.	X-Pos (ft)	Y-Pos (ft)	Load (lbs)	Spacing (ft)	Inclination (deg)	Length (ft)
1 Pier/Pile Load(s) Specified						
1	423.20	232.00	250000.0	12.0	90.00	80.0

NOTE - An Equivalent Line Load Is Calculated For Each Row Of Piers/Piles Assuming A Uniform Distribution Of Load Horizontally Between Individual Piers/Piles.

Janbus Empirical Coef is being used for the case of c & phi both > 0
A Critical Failure Surface Searching Method, Using A Random Technique For Generating Sliding Block Surfaces, Has Been Specified.

2000 Trial Surfaces Have Been Generated.
4 Boxes Specified For Generation Of Central Block Base
Length Of Line Segments For Active And Passive Portions Of Sliding Block Is 20.0

Box No.	X-Left (ft)	Y-Left (ft)	X-Right (ft)	Y-Right (ft)	Height (ft)
1					
2					
3					
4					

1	423.10	205.00	425.00	205.00	5.00
2	430.10	210.00	432.00	210.00	5.00
3	466.00	232.00	468.00	232.00	5.00
4	487.00	247.00	489.00	247.00	4.00

The Factor Of Safety For The Trial Failure Surface Defined By The Coordinates Listed Below Is Misleading.

Failure Surface Defined By 6 Coordinate Points

Point No.	X-Surf (ft)	Y-Surf (ft)
1	423.00	207.08
2	424.83	206.02
3	431.76	211.49
4	467.06	231.29
5	487.22	245.91
6	487.23	250.00

Factor Of Safety For The Preceding Specified Surface = -6.360

The Factor Of Safety For The Trial Failure Surface Defined By The Coordinates Listed Below Is Misleading.

Failure Surface Defined By 6 Coordinate Points

Point No.	X-Surf (ft)	Y-Surf (ft)
1	422.67	205.84
2	424.61	203.91
3	430.72	208.59
4	467.56	231.81
5	487.24	247.43
6	487.24	250.00

Factor Of Safety For The Preceding Specified Surface = -2.780

The Factor Of Safety For The Trial Failure Surface Defined By The Coordinates Listed Below Is Misleading.

Failure Surface Defined By 6 Coordinate Points

Point No.	X-Surf (ft)	Y-Surf (ft)
1	423.00	206.18
2	424.12	205.31
3	431.41	208.86
4	467.90	233.13
5	488.56	245.08
6	488.57	250.00

Factor Of Safety For The Preceding Specified Surface = -3.512

Following Are Displayed The Ten Most Critical Of The Trial Failure Surfaces Evaluated. They Are

Ordered - Most Critical First.

* * Safety Factors Are Calculated By The Simplified Janbu Method * *

Total Number of Trial Surfaces Attempted = 2000

Number of Trial Surfaces with Misleading FS = 3

Number of Trial Surfaces With Valid FS = 1997

Percentage of Trial Surfaces With Non-Valid FS Solutions

of the Total Attempted = 0.2 %

Statistical Data on All Valid FS Values:

FS Max = 60.358 FS Min = 1.550 FS Ave = 2.813

Standard Deviation = 1.555 Coefficient of Variation = 55.28 %

Failure Surface Specified By 6 Coordinate Points

Point No.	X-Surf (ft)	Y-Surf (ft)
1	422.364	205.682
2	423.448	204.599
3	431.293	209.060
4	466.294	232.219
5	488.918	248.838
6	490.039	250.000

Factor of Safety

*** 1.550 ***

Individual data on the 12 slices

Slice No.	Width (ft)	Weight (lbs)	Water Force		Tie Force		Earthquake Force		Surcharge Load (lbs)
			Top (lbs)	Bot (lbs)	Norm (lbs)	Tan (lbs)	Hor (lbs)	Ver (lbs)	
1	0.6	39.4	0.0	0.0	0.0	0.0	0.0	0.0	0.0
2	0.1	182.0	0.0	0.0	0.0	0.0	0.0	0.0	0.0

3	0.3	1232.6	0.0	0.0	0.0	0.0	0.0	0.0	0.0
4	5.6	18636.8	0.0	0.0	0.0	0.0	0.0	0.0	0.0
5	1.0	4284.8	0.0	0.0	540.0	0.0	0.0	0.0	0.0
6	1.3	6945.7	0.0	0.0	785.0	0.0	0.0	0.0	0.0
7	31.7	125511.7	0.0	0.0	51281.0	7658.0	0.0	0.0	0.0
8	3.3	8081.5	0.0	0.0	3096.0	2879.0	0.0	0.0	1647.2
9	0.7	1607.4	0.0	0.0	651.0	602.0	0.0	0.0	352.8
10	21.9	26249.4	0.0	0.0	11454.0	16312.0	0.0	0.0	10959.2
11	0.6	65.1	0.0	0.0	276.0	364.0	0.0	0.0	290.8
12	0.5	19.6	0.0	0.0	249.0	334.0	0.0	0.0	269.5

Failure Surface Specified By 6 Coordinate Points

Point No.	X-Surf (ft)	Y-Surf (ft)
1	422.773	205.886
2	423.228	205.437
3	430.176	208.549
4	466.860	232.705
5	487.413	246.898
6	490.501	250.000

Factor of Safety

*** 1.553 ***

Failure Surface Specified By 6 Coordinate Points

Point No.	X-Surf (ft)	Y-Surf (ft)
1	421.881	205.440
2	423.669	204.497
3	430.965	208.918
4	467.245	232.976
5	488.041	248.912
6	489.046	250.000

Factor of Safety

*** 1.577 ***

Failure Surface Specified By 6 Coordinate Points

Point No.	X-Surf (ft)	Y-Surf (ft)
1	422.430	205.715
2	423.556	204.843
3	430.718	208.445
4	466.220	231.370
5	488.625	248.470
6	489.996	250.000

Factor of Safety

*** 1.583 ***

Failure Surface Specified By 6 Coordinate Points

Point No.	X-Surf (ft)	Y-Surf (ft)
1	420.610	204.805
2	423.777	204.741
3	430.390	208.303
4	467.171	232.127
5	487.748	248.545
6	488.965	250.000

Factor of Safety

*** 1.589 ***

Failure Surface Specified By 6 Coordinate Points

Point No.	X-Surf (ft)	Y-Surf (ft)
1	422.999	205.763
2	423.512	205.305
3	430.296	209.082
4	466.940	232.964
5	488.572	248.136
6	489.952	250.000

Factor of Safety

*** 1.591 ***

Failure Surface Specified By 6 Coordinate Points

Point No.	X-Surf (ft)	Y-Surf (ft)
1	421.930	205.465
2	423.176	204.284

3	431.370	210.053
4	467.930	233.115
5	488.796	247.351
6	490.716	250.000

Factor of Safety
*** 1.594 ***

Failure Surface Specified By 6 Coordinate Points

Point No.	X-Surf (ft)	Y-Surf (ft)
1	421.855	205.427
2	423.896	204.538
3	431.912	209.214
4	466.813	232.432
5	488.492	247.929
6	490.512	250.000

Factor of Safety
*** 1.601 ***

Failure Surface Specified By 6 Coordinate Points

Point No.	X-Surf (ft)	Y-Surf (ft)
1	422.076	205.538
2	423.227	204.702
3	431.622	209.201
4	467.343	231.463
5	487.795	248.763
6	489.020	250.000

Factor of Safety
*** 1.610 ***

Failure Surface Specified By 6 Coordinate Points

Point No.	X-Surf (ft)	Y-Surf (ft)
1	423.000	205.961
2	423.740	205.346
3	431.243	209.377
4	466.507	232.420
5	487.022	247.154
6	489.411	250.000

Factor of Safety
*** 1.626 ***

**** END OF GSTABL7 OUTPUT ****

C-C' / Design / Search Along Clay / Caissons and Tiebacks / Pseudostatic

z:\2010\10132-01 south shores church - dana point\engineering\2012_10\proposed design\cc'_8p.pl2 Run By: Username 10/24/2012 08:23AM

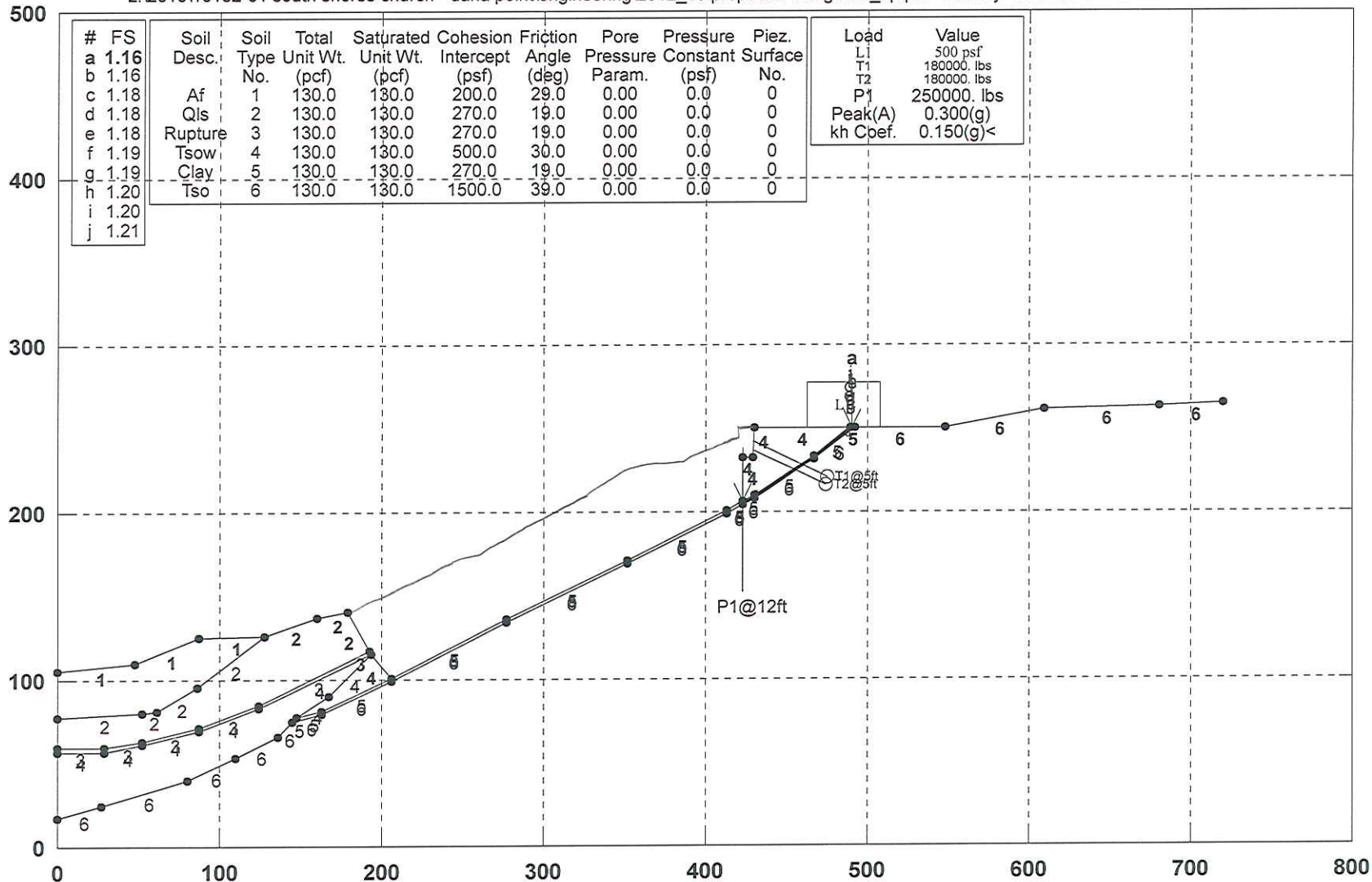

GSTABL7 v.2 FSmin=1.16

Safety Factors Are Calculated By The Simplified Janbu Method for the case of c & phi both > 0

*** GSTABL7 ***

** GSTABL7 by Dr. Garry H. Gregory, Ph.D., P.E., D.GE **

** Original Version 1.0, January 1996; Current Ver. 2.005.2, Jan. 2011 **
(All Rights Reserved-Unauthorizd Use Prohibited)

SLOPE STABILITY ANALYSIS SYSTEM

Modified Bishop, Simplified Janbu, or GLE Method of Slices.
(Includes Spencer & Morgenstern-Price Type Analysis)
Including Pier/Pile, Reinforcement, Soil Nail, Tieback,
Nonlinear Undrained Shear Strength, Curved Phi Envelope,
Anisotropic Soil, Fiber-Reinforced Soil, Boundary Loads, Water
Surfaces, Pseudo-Static & Newmark Earthquake, and Applied Forces.

Analysis Run Date: 10/24/2012
Time of Run: 08:23AM
Run By: Username
Input Data Filename: Z:\2010\10132-01 South Shores Church - Dana Point\Engineerin
g\2012_10\Proposed Design\cc'_8p.
Output Filename: Z:\2010\10132-01 South Shores Church - Dana Point\Engineerin
g\2012_10\Proposed Design\cc'_8p.OUT
Unit System: English
Plotted Output Filename: Z:\2010\10132-01 South Shores Church - Dana Point\Engineerin
g\2012_10\Proposed Design\cc'_8p.PLT

PROBLEM DESCRIPTION: C-C' / Design / Search Along Clay /
Caissons and Tiebacks / Pseudostatic

BOUNDARY COORDINATES

21 Top Boundaries
57 Total Boundaries

Boundary No.	X-Left (ft)	Y-Left (ft)	X-Right (ft)	Y-Right (ft)	Soil Type Below Bnd
1	0.00	105.00	48.00	110.00	1
2	48.00	110.00	87.00	125.00	1
3	87.00	125.00	128.00	126.00	1
4	128.00	126.00	160.00	137.00	2
5	160.00	137.00	179.00	140.00	2
6	179.00	140.00	193.00	117.00	2
7	193.00	117.00	193.10	115.00	3
8	193.10	115.00	206.00	101.00	4
9	206.00	101.00	277.00	136.00	5
10	277.00	136.00	352.00	171.00	5
11	352.00	171.00	413.00	201.00	5
12	413.00	201.00	423.00	206.00	5
13	423.00	206.00	423.10	232.00	4
14	423.10	232.00	429.00	232.00	4
15	429.00	232.00	430.00	250.00	4
16	430.00	250.00	489.50	250.00	4
17	489.50	250.00	492.50	250.00	5
18	492.50	250.00	548.00	250.00	6
19	548.00	250.00	609.00	261.00	6
20	609.00	261.00	680.00	263.00	6
21	680.00	263.00	720.00	265.00	6
22	0.00	77.00	52.00	80.00	2
23	52.00	80.00	61.00	81.00	2
24	61.00	81.00	86.00	95.00	2
25	86.00	95.00	128.00	126.00	2
26	0.00	59.00	29.00	59.00	3
27	29.00	59.00	52.00	63.00	3
28	52.00	63.00	87.00	71.00	3
29	87.00	71.00	124.00	85.00	3
30	124.00	85.00	193.00	117.00	3
31	0.00	57.00	29.00	57.00	4
32	29.00	57.00	52.00	61.00	4
33	52.00	61.00	87.00	69.00	4
34	87.00	69.00	124.00	83.00	4
35	124.00	83.00	193.10	115.00	4
36	0.00	17.00	27.00	24.00	6
37	27.00	24.00	80.00	40.00	6
38	80.00	40.00	110.00	53.00	6
39	110.00	53.00	136.00	66.00	6
40	136.00	66.00	145.00	75.00	6

41	145.00	75.00	148.00	77.00	5
42	148.00	77.00	167.00	90.00	4
43	167.00	90.00	193.10	115.00	4
44	148.00	77.00	163.00	81.00	5
45	163.00	81.00	206.00	101.00	5
46	423.00	206.00	430.00	210.00	5
47	430.00	210.00	467.00	233.00	5
48	467.00	233.00	489.50	250.00	5
49	145.00	75.00	163.00	79.00	6
50	163.00	79.00	206.00	99.00	6
51	206.00	99.00	277.00	134.00	6
52	277.00	134.00	352.00	169.00	6
53	352.00	169.00	413.00	199.00	6
54	413.00	199.00	423.00	204.00	6
55	423.00	204.00	430.00	208.00	6
56	430.00	208.00	467.00	231.00	6
57	467.00	231.00	492.50	250.00	6

Default Y-Origin = 0.00(ft)
Default X-Plus Value = 0.00(ft)
Default Y-Plus Value = 0.00(ft)

ISOTROPIC SOIL PARAMETERS

6 Type(s) of Soil

Soil No.	Total (pcf)	Saturated (pcf)	Cohesion (psf)	Friction Angle (deg)	Pore Pressure Param. (psf)	Pressure Constant	Piez. Surface
1	130.0	130.0	200.0	29.0	0.00	0.0	0
2	130.0	130.0	270.0	19.0	0.00	0.0	0
3	130.0	130.0	270.0	19.0	0.00	0.0	0
4	130.0	130.0	500.0	30.0	0.00	0.0	0
5	130.0	130.0	270.0	19.0	0.00	0.0	0
6	130.0	130.0	1500.0	39.0	0.00	0.0	0

BOUNDARY LOAD(S)

1 Load(s) Specified

Load No.	X-Left (ft)	X-Right (ft)	Intensity (psf)	Deflection (deg)
1	463.00	508.00	500.0	0.0

NOTE - Intensity Is Specified As A Uniformly Distributed

Force Acting On A Horizontally Projected Surface.

Specified Peak Ground Acceleration Coefficient (A) = 0.300(g)

Specified Horizontal Earthquake Coefficient (kh) = 0.150(g)

Specified Vertical Earthquake Coefficient (kv) = 0.000(g)

Specified Seismic Pore-Pressure Factor = 0.000

TIEBACK LOAD(S)

2 Tieback Load(s) Specified

Tieback No.	X-Pos (ft)	Y-Pos (ft)	Load (lbs)	Spacing (ft)	Inclination (deg)	Length (ft)	Force Method
1	429.56	242.00	180000.0	5.0	25.00	50.0	2
2	429.28	237.00	180000.0	5.0	25.00	50.0	2

NOTE - An Equivalent Line Load Is Calculated For Each Row Of Tiebacks

Assuming A Uniform Distribution Of Load Horizontally Between Individual

Tiebacks. Force Method 1 Considers Only Tangential Tieback Forces.

Force Method 2 Considers Both Tangential and Normal Tieback Forces.

Force Method 3 Considers Only Normal Tieback Forces.

Force Method 4 Limits Normal and Tangential Tieback-Force Distribution

to 1.5 Times The Tieback Inclination, or to 30 Degrees Below (Left of)

the Tieback-Failure Surface Intersection, Whichever is Greater.

PIER/PILE LOAD(S)

1 Pier/Pile Load(s) Specified

Pier/Pile No.	X-Pos (ft)	Y-Pos (ft)	Load (lbs)	Spacing (ft)	Inclination (deg)	Length (ft)
1	423.20	232.00	250000.0	12.0	90.00	80.0

NOTE - An Equivalent Line Load Is Calculated For Each Row Of Piers/Piles

Assuming A Uniform Distribution Of Load Horizontally Between

Individual Piers/Piles.

Janbus Empirical Coef is being used for the case of c & phi both > 0

A Critical Failure Surface Searching Method, Using A Random

Technique For Generating Sliding Block Surfaces, Has Been

Specified.

2000 Trial Surfaces Have Been Generated.

4 Boxes Specified For Generation Of Central Block Base

Length Of Line Segments For Active And Passive Portions Of Sliding Block Is 20.0

Box No.	X-Left (ft)	Y-Left (ft)	X-Right (ft)	Y-Right (ft)	Height (ft)
1	423.10	205.00	425.00	205.00	5.00
2	430.10	210.00	432.00	210.00	5.00
3	466.00	232.00	468.00	232.00	5.00
4	487.00	247.00	489.00	247.00	4.00

The Factor Of Safety For The Trial Failure Surface Defined By The Coordinates Listed Below Is Misleading.

Failure Surface Defined By 6 Coordinate Points

Point No.	X-Surf (ft)	Y-Surf (ft)
1	422.67	205.84
2	424.61	203.91
3	430.72	208.59
4	467.56	231.81
5	487.24	247.43
6	487.24	250.00

Factor Of Safety For The Preceding Specified Surface = -4.158

The Factor Of Safety For The Trial Failure Surface Defined By The Coordinates Listed Below Is Misleading.

Failure Surface Defined By 6 Coordinate Points

Point No.	X-Surf (ft)	Y-Surf (ft)
1	423.00	206.18
2	424.12	205.31
3	431.41	208.86
4	467.90	233.13
5	488.56	245.08
6	488.57	250.00

Factor Of Safety For The Preceding Specified Surface = -6.186

Following Are Displayed The Ten Most Critical Of The Trial Failure Surfaces Evaluated. They Are

Ordered - Most Critical First.

* * Safety Factors Are Calculated By The Simplified Janbu Method * *

Total Number of Trial Surfaces Attempted = 2000

Number of Trial Surfaces with Misleading FS = 2

Number of Trial Surfaces with Valid FS = 1998

Percentage of Trial Surfaces with Non-Valid FS Solutions of the Total Attempted = 0.1 %

Statistical Data on All Valid FS Values:

FS Max = 7.554 FS Min = 1.156 FS Ave = 2.010

Standard Deviation = 0.530 Coefficient of Variation = 26.37 %

Failure Surface Specified By 6 Coordinate Points

Point No.	X-Surf (ft)	Y-Surf (ft)
1	422.773	205.886
2	423.228	205.437
3	430.176	208.549
4	466.860	232.705
5	487.413	246.898
6	490.501	250.000

Factor of Safety

*** 1.156 ***

Individual data on the

Slice No.	Width (ft)	Weight (lbs)	Water Force		Tie Force		Earthquake Force		Surcharge (lbs)
			Top (lbs)	Bot (lbs)	Norm (lbs)	Tan (lbs)	Hor (lbs)	Ver (lbs)	
1	0.2	5.0	0.0	0.0	0.0	0.0	0.7	0.0	0.0
2	0.1	174.0	0.0	0.0	0.0	0.0	26.1	0.0	0.0
3	0.1	442.3	0.0	0.0	0.0	0.0	66.3	0.0	0.0
4	5.8	18960.5	0.0	0.0	0.0	0.0	2844.1	0.0	0.0
5	1.0	4257.9	0.0	0.0	536.0	0.0	638.7	0.0	0.0
6	0.2	945.6	0.0	0.0	99.0	0.0	142.0	0.0	0.0
7	32.8	130761.0	0.0	0.0	52365.0	6838.0	19614.1	0.0	0.0
8	3.9	9315.6	0.0	0.0	3504.0	3337.0	1397.3	0.0	1929.9
9	0.1	314.5	0.0	0.0	120.0	119.0	47.2	0.0	70.1
10	20.4	26935.1	0.0	0.0	10414.0	15147.0	4040.3	0.0	10206.7

11	2.1	557.1	0.0	0.0	988.0	1299.0	83.6	0.0	1043.3
12	1.0	65.4	0.0	0.0	441.0	606.0	9.8	0.0	500.5

Failure Surface Specified By 6 Coordinate Points

Point No.	X-Surf (ft)	Y-Surf (ft)
1	422.364	205.682
2	423.448	204.599
3	431.293	209.060
4	466.294	232.219
5	488.918	248.838
6	490.039	250.000

Factor of Safety

*** 1.158 ***

Failure Surface Specified By 6 Coordinate Points

Point No.	X-Surf (ft)	Y-Surf (ft)
1	422.430	205.715
2	423.556	204.843
3	430.718	208.445
4	466.220	231.370
5	488.625	248.470
6	489.996	250.000

Factor of Safety

*** 1.178 ***

Failure Surface Specified By 6 Coordinate Points

Point No.	X-Surf (ft)	Y-Surf (ft)
1	422.999	205.763
2	423.512	205.305
3	430.296	209.082
4	466.940	232.964
5	488.572	248.136
6	489.952	250.000

Factor of Safety

*** 1.183 ***

Failure Surface Specified By 6 Coordinate Points

Point No.	X-Surf (ft)	Y-Surf (ft)
1	421.881	205.440
2	423.669	204.497
3	430.965	208.918
4	467.245	232.976
5	488.041	248.912
6	489.046	250.000

Factor of Safety

*** 1.184 ***

Failure Surface Specified By 6 Coordinate Points

Point No.	X-Surf (ft)	Y-Surf (ft)
1	421.930	205.465
2	423.176	204.284
3	431.370	210.053
4	467.930	233.115
5	488.796	247.351
6	490.716	250.000

Factor of Safety

*** 1.187 ***

Failure Surface Specified By 6 Coordinate Points

Point No.	X-Surf (ft)	Y-Surf (ft)
1	420.610	204.805
2	423.777	204.741
3	430.390	208.303
4	467.171	232.127
5	487.748	248.545
6	488.965	250.000

Factor of Safety

*** 1.192 ***

Failure Surface Specified By 6 Coordinate Points

Point No.	X-Surf (ft)	Y-Surf (ft)
-----------	-------------	-------------

No.	(ft)	(ft)
1	421.855	205.427
2	423.896	204.538
3	431.912	209.214
4	466.813	232.432
5	488.492	247.929
6	490.512	250.000

Factor of Safety

*** 1.195 ***

Failure Surface Specified By 6 Coordinate Points

Point	X-Surf	Y-Surf
No.	(ft)	(ft)
1	422.076	205.538
2	423.227	204.702
3	431.622	209.201
4	467.343	231.463
5	487.795	248.763
6	489.020	250.000

Factor of Safety

*** 1.195 ***

Failure Surface Specified By 6 Coordinate Points

Point	X-Surf	Y-Surf
No.	(ft)	(ft)
1	423.000	205.961
2	423.740	205.346
3	431.243	209.377
4	466.507	232.420
5	487.022	247.154
6	489.411	250.000

Factor of Safety

*** 1.205 ***

**** END OF GSTABL7 OUTPUT ****

D-D' / Design / Search Within Tsow /

z:\2010\10132-01 south shores church - dana point\engineering\2012_10\proposed design\dd'_2.pl2 Run By: Username 10/19/2012 03:55PM

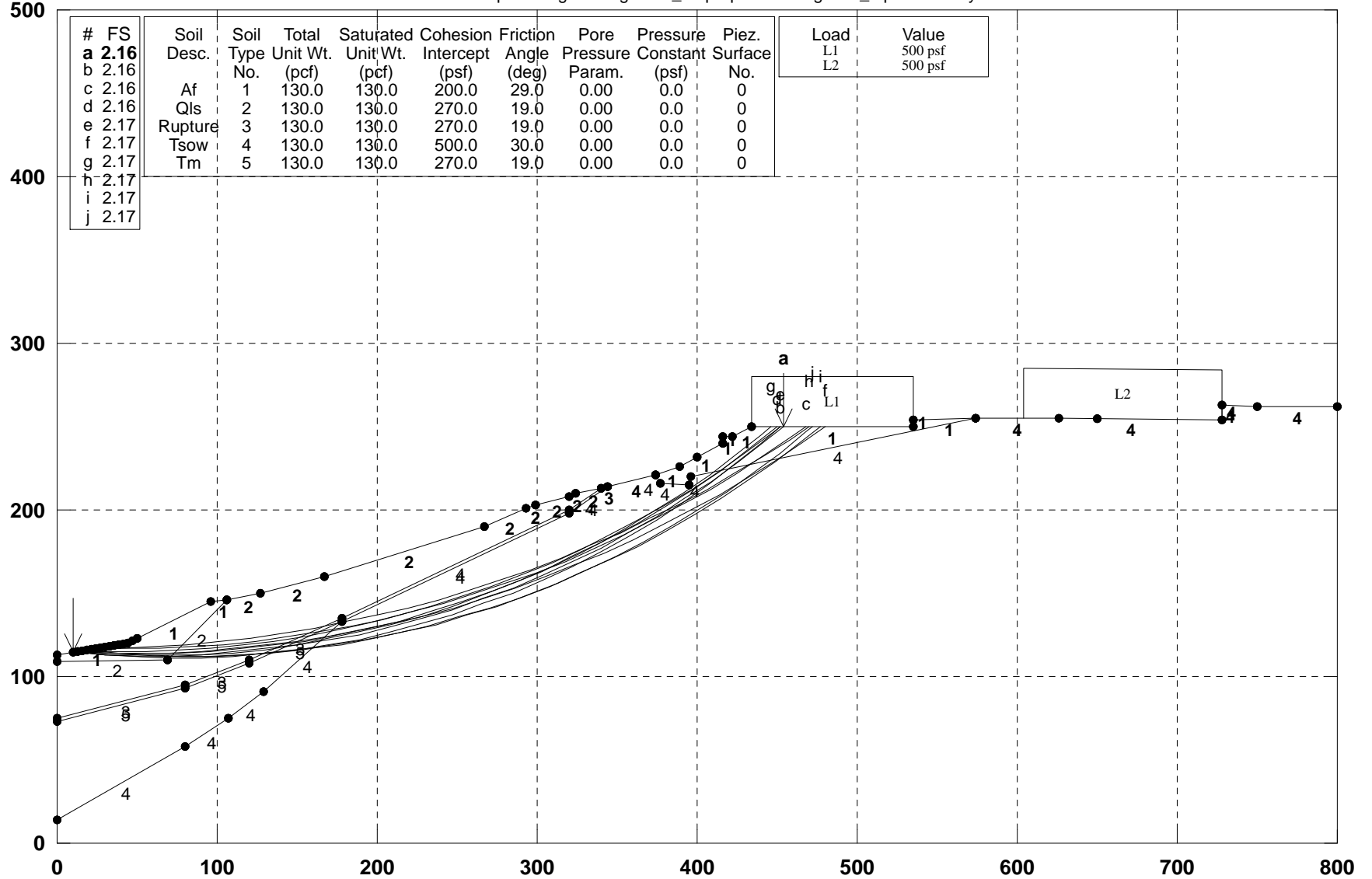

GSTABL7 v.2 FSmin=2.16

Safety Factors Are Calculated By The Modified Bishop Method

*** GSTABL7 ***

** GSTABL7 by Dr. Garry H. Gregory, Ph.D.,P.E.,D.GE **

** Original Version 1.0, January 1996; Current Ver. 2.005.2, Jan. 2011 **
(All Rights Reserved-Unauthorizd Use Prohibited)

SLOPE STABILITY ANALYSIS SYSTEM

Modified Bishop, Simplified Janbu, or GLE Method of Slices.
(Includes Spencer & Morgenstern-Price Type Analysis)
Including Pier/Pile, Reinforcement, Soil Nail, Tieback,
Nonlinear Undrained Shear Strength, Curved Phi Envelope,
Anisotropic Soil, Fiber-Reinforced Soil, Boundary Loads, Water
Surfaces, Pseudo-Static & Newmark Earthquake, and Applied Forces.

Analysis Run Date: 10/19/2012
Time of Run: 03:55PM
Run By: Username
Input Data Filename: Z:\2010\10132-01 South Shores Church - Dana Point\Engineerin
g\2012_10\Proposed Design\dd'_2.
Output Filename: Z:\2010\10132-01 South Shores Church - Dana Point\Engineerin
g\2012_10\Proposed Design\dd'_2.OUT
Unit System: English
Plotted Output Filename: Z:\2010\10132-01 South Shores Church - Dana Point\Engineerin
g\2012_10\Proposed Design\dd'_2.PLT

PROBLEM DESCRIPTION: D-D' / Design / Search Within Tsow /

BOUNDARY COORDINATES
26 Top Boundaries
46 Total Boundaries

Boundary No.	X-Left (ft)	Y-Left (ft)	X-Right (ft)	Y-Right (ft)	Soil Type Below Bnd
1	0.00	113.00	44.00	120.00	1
2	44.00	120.00	96.00	145.00	1
3	96.00	145.00	106.00	146.00	1
4	106.00	146.00	127.00	150.00	2
5	127.00	150.00	167.00	160.00	2
6	167.00	160.00	267.00	190.00	2
7	267.00	190.00	293.00	201.00	2
8	293.00	201.00	299.00	203.00	2
9	299.00	203.00	320.00	208.00	2
10	320.00	208.00	324.00	210.00	2
11	324.00	210.00	340.00	213.00	2
12	340.00	213.00	344.00	214.00	3
13	344.00	214.00	374.00	221.00	4
14	374.00	221.00	389.00	226.00	1
15	389.00	226.00	416.00	240.00	1
16	416.00	240.00	416.10	244.00	1
17	416.10	244.00	422.00	244.00	1
18	422.00	244.00	434.00	250.00	1
19	434.00	250.00	535.00	250.00	1
20	535.00	250.00	535.10	254.00	1
21	535.10	254.00	574.00	255.00	1
22	574.00	255.00	626.00	255.00	4
23	626.00	255.00	728.00	254.00	4
24	728.00	254.00	728.10	263.00	4
25	728.10	263.00	750.00	262.00	4
26	750.00	262.00	800.00	262.00	4
27	0.00	109.00	69.00	110.00	2
28	69.00	110.00	106.00	146.00	2
29	0.00	75.00	80.00	95.00	3
30	80.00	95.00	120.00	110.00	3
31	120.00	110.00	178.00	135.00	3
32	178.00	135.00	320.00	200.00	4
33	320.00	200.00	340.00	213.00	4
34	0.00	73.00	80.00	93.00	5
35	80.00	93.00	120.00	108.00	5
36	120.00	108.00	178.00	133.00	5
37	178.00	133.00	320.00	198.00	4
38	320.00	198.00	344.00	214.00	4
39	0.00	14.00	80.00	58.00	4
40	80.00	58.00	107.00	75.00	4
41	107.00	75.00	129.00	91.00	4

42	129.00	91.00	178.00	133.00	4
43	374.00	221.00	377.00	216.00	4
44	377.00	216.00	395.00	215.00	4
45	395.00	215.00	396.00	220.00	4
46	396.00	220.00	574.00	255.00	4

Default Y-Origin = 0.00(ft)
Default X-Plus Value = 0.00(ft)
Default Y-Plus Value = 0.00(ft)

ISOTROPIC SOIL PARAMETERS

Soil No.	Total (pcf)	Saturated (pcf)	Cohesion (psf)	Friction (deg)	Pore Pressure Param. (psf)	Pressure Constant (psf)	Piez. Surface No.
1	130.0	130.0	200.0	29.0	0.00	0.0	0
2	130.0	130.0	270.0	19.0	0.00	0.0	0
3	130.0	130.0	270.0	19.0	0.00	0.0	0
4	130.0	130.0	500.0	30.0	0.00	0.0	0
5	130.0	130.0	270.0	19.0	0.00	0.0	0

BOUNDARY LOAD(S)

Load No.	X-Left (ft)	X-Right (ft)	Intensity (psf)	Deflection (deg)
1	434.00	535.00	500.0	0.0
2	604.00	728.00	500.0	0.0

NOTE - Intensity Is Specified As A Uniformly Distributed Force Acting On A Horizontally Projected Surface.
A Critical Failure Surface Searching Method, Using A Random Technique For Generating Circular Surfaces, Has Been Specified.
1500 Trial Surfaces Have Been Generated.
100 Surface(s) Initiate(s) From Each Of 15 Points Equally Spaced Along The Ground Surface Between X = 10.00(ft) and X = 50.00(ft)

Each Surface Terminates Between X = 400.00(ft) and X = 650.00(ft)

Unless Further Limitations Were Imposed, The Minimum Elevation At Which A Surface Extends Is Y = 0.00(ft)
20.00(ft) Line Segments Define Each Trial Failure Surface.
Following Are Displayed The Ten Most Critical Of The Trial Failure Surfaces Evaluated. They Are

Ordered - Most Critical First.
* * Safety Factors Are Calculated By The Modified Bishop Method * *

Total Number of Trial Surfaces Attempted = 1500
Number of Trial Surfaces With Valid FS = 1500
Statistical Data On All Valid FS Values:
FS Max = 4.050 FS Min = 2.158 FS Ave = 3.023
Standard Deviation = 0.479 Coefficient of Variation = 15.85 %

Failure Surface Specified By 25 Coordinate Points

Point No.	X-Surf (ft)	Y-Surf (ft)
1	10.000	114.591
2	29.954	113.238
3	49.941	112.523
4	69.941	112.448
5	89.933	113.012
6	109.897	114.215
7	129.812	116.056
8	149.658	118.532
9	169.415	121.641
10	189.063	125.380
11	208.580	129.746
12	227.949	134.733
13	247.148	140.337
14	266.158	146.551
15	284.959	153.370
16	303.533	160.787
17	321.861	168.793
18	339.923	177.381
19	357.701	186.543
20	375.178	196.267
21	392.334	206.546

22 409.154 217.368
 23 425.619 228.722
 24 441.712 240.596
 25 453.640 250.000
 Circle Center At X = 62.294 ; Y = 737.983 ; and Radius = 625.581

Factor of Safety
 *** 2.158 ***

Slice No.	Width (ft)	Weight (lbs)	Water Force		Tie Force		Earthquake Force		Surcharge	
			Top (lbs)	Bot (lbs)	Norm (lbs)	Tan (lbs)	Hor (lbs)	Ver (lbs)	Load (lbs)	
1	20.0	5872.4	0.0	0.0	0.0	0.0	0.0	0.0	0.0	0.0
2	14.0	10765.7	0.0	0.0	0.0	0.0	0.0	0.0	0.0	0.0
3	5.9	6795.9	0.0	0.0	0.0	0.0	0.0	0.0	0.0	0.0
4	20.0	39463.4	0.0	0.0	0.0	0.0	0.0	0.0	0.0	0.0
5	1.6	4299.4	0.0	0.0	0.0	0.0	0.0	0.0	0.0	0.0
6	18.4	59498.2	0.0	0.0	0.0	0.0	0.0	0.0	0.0	0.0
7	6.1	23933.4	0.0	0.0	0.0	0.0	0.0	0.0	0.0	0.0
8	10.0	41367.1	0.0	0.0	0.0	0.0	0.0	0.0	0.0	0.0
9	3.9	16350.4	0.0	0.0	0.0	0.0	0.0	0.0	0.0	0.0
10	17.1	74184.4	0.0	0.0	0.0	0.0	0.0	0.0	0.0	0.0
11	2.8	12585.8	0.0	0.0	0.0	0.0	0.0	0.0	0.0	0.0
12	6.0	27148.2	0.0	0.0	0.0	0.0	0.0	0.0	0.0	0.0
13	6.5	30394.4	0.0	0.0	0.0	0.0	0.0	0.0	0.0	0.0
14	7.4	35053.6	0.0	0.0	0.0	0.0	0.0	0.0	0.0	0.0
15	14.0	68961.4	0.0	0.0	0.0	0.0	0.0	0.0	0.0	0.0
16	3.3	16561.6	0.0	0.0	0.0	0.0	0.0	0.0	0.0	0.0
17	2.4	12217.2	0.0	0.0	0.0	0.0	0.0	0.0	0.0	0.0
18	8.6	44143.4	0.0	0.0	0.0	0.0	0.0	0.0	0.0	0.0
19	11.1	58433.7	0.0	0.0	0.0	0.0	0.0	0.0	0.0	0.0
20	19.5	106524.8	0.0	0.0	0.0	0.0	0.0	0.0	0.0	0.0
21	19.4	108621.0	0.0	0.0	0.0	0.0	0.0	0.0	0.0	0.0
22	19.2	108893.7	0.0	0.0	0.0	0.0	0.0	0.0	0.0	0.0
23	19.0	107382.8	0.0	0.0	0.0	0.0	0.0	0.0	0.0	0.0
24	0.8	4728.2	0.0	0.0	0.0	0.0	0.0	0.0	0.0	0.0
25	18.0	101992.5	0.0	0.0	0.0	0.0	0.0	0.0	0.0	0.0
26	8.0	46332.1	0.0	0.0	0.0	0.0	0.0	0.0	0.0	0.0
27	6.0	34492.7	0.0	0.0	0.0	0.0	0.0	0.0	0.0	0.0
28	4.5	25728.3	0.0	0.0	0.0	0.0	0.0	0.0	0.0	0.0
29	16.5	89173.0	0.0	0.0	0.0	0.0	0.0	0.0	0.0	0.0
30	1.9	9694.4	0.0	0.0	0.0	0.0	0.0	0.0	0.0	0.0
31	2.1	11170.1	0.0	0.0	0.0	0.0	0.0	0.0	0.0	0.0
32	15.9	78445.4	0.0	0.0	0.0	0.0	0.0	0.0	0.0	0.0
33	0.1	357.1	0.0	0.0	0.0	0.0	0.0	0.0	0.0	0.0
34	4.0	18225.1	0.0	0.0	0.0	0.0	0.0	0.0	0.0	0.0
35	13.7	58041.0	0.0	0.0	0.0	0.0	0.0	0.0	0.0	0.0
36	16.3	59372.4	0.0	0.0	0.0	0.0	0.0	0.0	0.0	0.0
37	1.2	3866.8	0.0	0.0	0.0	0.0	0.0	0.0	0.0	0.0
38	1.8	5894.7	0.0	0.0	0.0	0.0	0.0	0.0	0.0	0.0
39	12.0	35952.1	0.0	0.0	0.0	0.0	0.0	0.0	0.0	0.0
40	3.3	9240.4	0.0	0.0	0.0	0.0	0.0	0.0	0.0	0.0
41	2.7	7282.9	0.0	0.0	0.0	0.0	0.0	0.0	0.0	0.0
42	1.0	2702.4	0.0	0.0	0.0	0.0	0.0	0.0	0.0	0.0
43	13.2	34035.1	0.0	0.0	0.0	0.0	0.0	0.0	0.0	0.0
44	6.8	16462.5	0.0	0.0	0.0	0.0	0.0	0.0	0.0	0.0
45	0.1	258.4	0.0	0.0	0.0	0.0	0.0	0.0	0.0	0.0
46	3.6	9742.6	0.0	0.0	0.0	0.0	0.0	0.0	0.0	0.0
47	2.3	5450.1	0.0	0.0	0.0	0.0	0.0	0.0	0.0	0.0
48	3.6	8199.6	0.0	0.0	0.0	0.0	0.0	0.0	0.0	0.0
49	8.4	17532.6	0.0	0.0	0.0	0.0	0.0	0.0	0.0	0.0
50	7.7	12280.5	0.0	0.0	0.0	0.0	0.0	0.0	3856.0	0.0
51	11.9	7291.0	0.0	0.0	0.0	0.0	0.0	0.0	5963.8	0.0

Failure Surface Specified By 25 Coordinate Points

Point No.	X-Surf (ft)	Y-Surf (ft)
1	15.714	115.500
2	35.708	114.992
3	55.708	115.067
4	75.697	115.723

5	95.659	116.961
6	115.576	118.778
7	135.432	121.175
8	155.209	124.148
9	174.892	127.696
10	194.464	131.815
11	213.907	136.501
12	233.205	141.752
13	252.343	147.561
14	271.303	153.925
15	290.071	160.838
16	308.629	168.294
17	326.962	176.287
18	345.055	184.810
19	362.893	193.856
20	380.459	203.417
21	397.741	213.485
22	414.721	224.051
23	431.387	235.108
24	447.725	246.644
25	452.195	250.000

Circle Center At X = 43.153 ; Y = 802.240 ; and Radius = 687.288

Factor of Safety
 *** 2.161 ***

Failure Surface Specified By 25 Coordinate Points

Point No.	X-Surf (ft)	Y-Surf (ft)
1	24.286	116.864
2	44.285	116.673
3	64.282	117.015
4	84.263	117.890
5	104.213	119.298
6	124.119	121.237
7	143.966	123.707
8	163.740	126.704
9	183.427	130.228
10	203.013	134.276
11	222.484	138.844
12	241.827	143.930
13	261.027	149.530
14	280.071	155.639
15	298.945	162.254
16	317.637	169.371
17	336.131	176.983
18	354.417	185.085
19	372.479	193.672
20	390.307	202.738
21	407.886	212.276
22	425.205	222.279
23	442.250	232.740
24	459.011	243.652
25	468.215	250.000

Circle Center At X = 41.447 ; Y = 866.697 ; and Radius = 750.030

Factor of Safety
 *** 2.162 ***

Failure Surface Specified By 25 Coordinate Points

Point No.	X-Surf (ft)	Y-Surf (ft)
1	15.714	115.500
2	35.687	114.462
3	55.683	114.055
4	75.682	114.281
5	95.664	115.138
6	115.608	116.626
7	135.496	118.743
8	155.306	121.488
9	175.021	124.857
10	194.619	128.848
11	214.081	133.455
12	233.387	138.675

13	252.519	144.503
14	271.458	150.932
15	290.184	157.956
16	308.679	165.569
17	326.923	173.762
18	344.900	182.527
19	362.591	191.856
20	379.979	201.739
21	397.045	212.166
22	413.774	223.128
23	430.148	234.612
24	446.151	246.608
25	450.390	250.000

Circle Center At X = 58.549 ; Y = 746.999 ; and Radius = 632.950
 Factor of Safety
 *** 2.163 ***

Failure Surface Specified By 25 Coordinate Points

Point No.	X-Surf (ft)	Y-Surf (ft)
1	10.000	114.591
2	29.913	112.724
3	49.878	111.541
4	69.871	111.044
5	89.871	111.233
6	109.851	112.109
7	129.790	113.669
8	149.664	115.913
9	169.449	118.838
10	189.122	122.439
11	208.660	126.714
12	228.040	131.656
13	247.239	137.260
14	266.234	143.520
15	285.003	150.428
16	303.524	157.976
17	321.775	166.155
18	339.735	174.956
19	357.382	184.367
20	374.696	194.379
21	391.656	204.978
22	408.242	216.154
23	424.436	227.892
24	440.217	240.178
25	451.976	250.000

Circle Center At X = 74.354 ; Y = 693.813 ; and Radius = 582.786
 Factor of Safety
 *** 2.165 ***

Failure Surface Specified By 26 Coordinate Points

Point No.	X-Surf (ft)	Y-Surf (ft)
1	10.000	114.591
2	29.990	113.965
3	49.990	113.862
4	69.986	114.280
5	89.963	115.220
6	109.910	116.680
7	129.812	118.661
8	149.655	121.160
9	169.426	124.176
10	189.112	127.707
11	208.699	131.750
12	228.174	136.303
13	247.524	141.362
14	266.734	146.925
15	285.794	152.987
16	304.688	159.544
17	323.405	166.592
18	341.932	174.126
19	360.256	182.141
20	378.364	190.631

21	396.245	199.590
22	413.886	209.013
23	431.275	218.894
24	448.401	229.224
25	465.251	239.998
26	480.030	250.000

Circle Center At X = 43.991 ; Y = 880.086 ; and Radius = 766.250
 Factor of Safety
 *** 2.166 ***

Failure Surface Specified By 25 Coordinate Points

Point No.	X-Surf (ft)	Y-Surf (ft)
1	10.000	114.591
2	29.961	113.345
3	49.952	112.747
4	69.952	112.799
5	89.940	113.499
6	109.894	114.847
7	129.795	116.842
8	149.620	119.481
9	169.349	122.763
10	188.961	126.683
11	208.435	131.236
12	227.752	136.420
13	246.890	142.227
14	265.830	148.652
15	284.552	155.689
16	303.035	163.329
17	321.260	171.565
18	339.209	180.387
19	356.862	189.788
20	374.201	199.756
21	391.208	210.281
22	407.863	221.353
23	424.151	232.959
24	440.054	245.088
25	446.079	250.000

Circle Center At X = 58.372 ; Y = 729.053 ; and Radius = 616.364
 Factor of Safety
 *** 2.168 ***

Failure Surface Specified By 25 Coordinate Points

Point No.	X-Surf (ft)	Y-Surf (ft)
1	21.429	116.409
2	41.425	116.764
3	61.408	117.596
4	81.365	118.906
5	101.285	120.692
6	121.157	122.953
7	140.969	125.688
8	160.710	128.896
9	180.369	132.575
10	199.934	136.722
11	219.395	141.335
12	238.740	146.412
13	257.958	151.949
14	277.038	157.944
15	295.970	164.393
16	314.742	171.292
17	333.345	178.638
18	351.766	186.426
19	369.996	194.652
20	388.024	203.312
21	405.840	212.399
22	423.435	221.909
23	440.797	231.837
24	457.916	242.177
25	470.197	250.000

Circle Center At X = 16.575 ; Y = 953.573 ; and Radius = 837.178
 Factor of Safety

*** 2.168 ***
 Failure Surface Specified By 26 Coordinate Points

Point No.	X-Surf (ft)	Y-Surf (ft)
1	12.857	115.045
2	32.787	113.374
3	52.759	112.318
4	72.754	111.879
5	92.754	112.057
6	112.738	112.852
7	132.688	114.264
8	152.585	116.290
9	172.410	118.930
10	192.144	122.180
11	211.769	126.038
12	231.265	130.500
13	250.614	135.561
14	269.797	141.217
15	288.797	147.462
16	307.595	154.290
17	326.174	161.696
18	344.515	169.671
19	362.601	178.208
20	380.415	187.300
21	397.941	196.937
22	415.160	207.110
23	432.057	217.809
24	448.616	229.026
25	464.821	240.747
26	476.815	250.000

Circle Center At X = 77.015 ; Y = 759.473 ; and Radius = 647.613
 Factor of Safety

*** 2.169 ***
 Failure Surface Specified By 26 Coordinate Points

Point No.	X-Surf (ft)	Y-Surf (ft)
1	18.571	115.955
2	38.483	114.080
3	58.446	112.859
4	78.438	112.293
5	98.438	112.383
6	118.424	113.129
7	138.375	114.529
8	158.269	116.583
9	178.085	119.287
10	197.802	122.640
11	217.399	126.637
12	236.854	131.275
13	256.146	136.548
14	275.255	142.450
15	294.161	148.976
16	312.842	156.118
17	331.279	163.868
18	349.453	172.219
19	367.342	181.161
20	384.929	190.685
21	402.194	200.780
22	419.119	211.436
23	435.686	222.640
24	451.876	234.382
25	467.673	246.648
26	471.709	250.000

Circle Center At X = 85.731 ; Y = 721.856 ; and Radius = 609.613
 Factor of Safety

*** 2.171 ***
 ***** END OF GSTABL7 OUTPUT *****

D-D' / Design / Search Within Tsow / Pseudostatic

z:\2010\10132-01 south shores church - dana point\engineering\2012_10\proposed design\dd'_2p.pl2 Run By: Username 10/19/2012 03:56PM

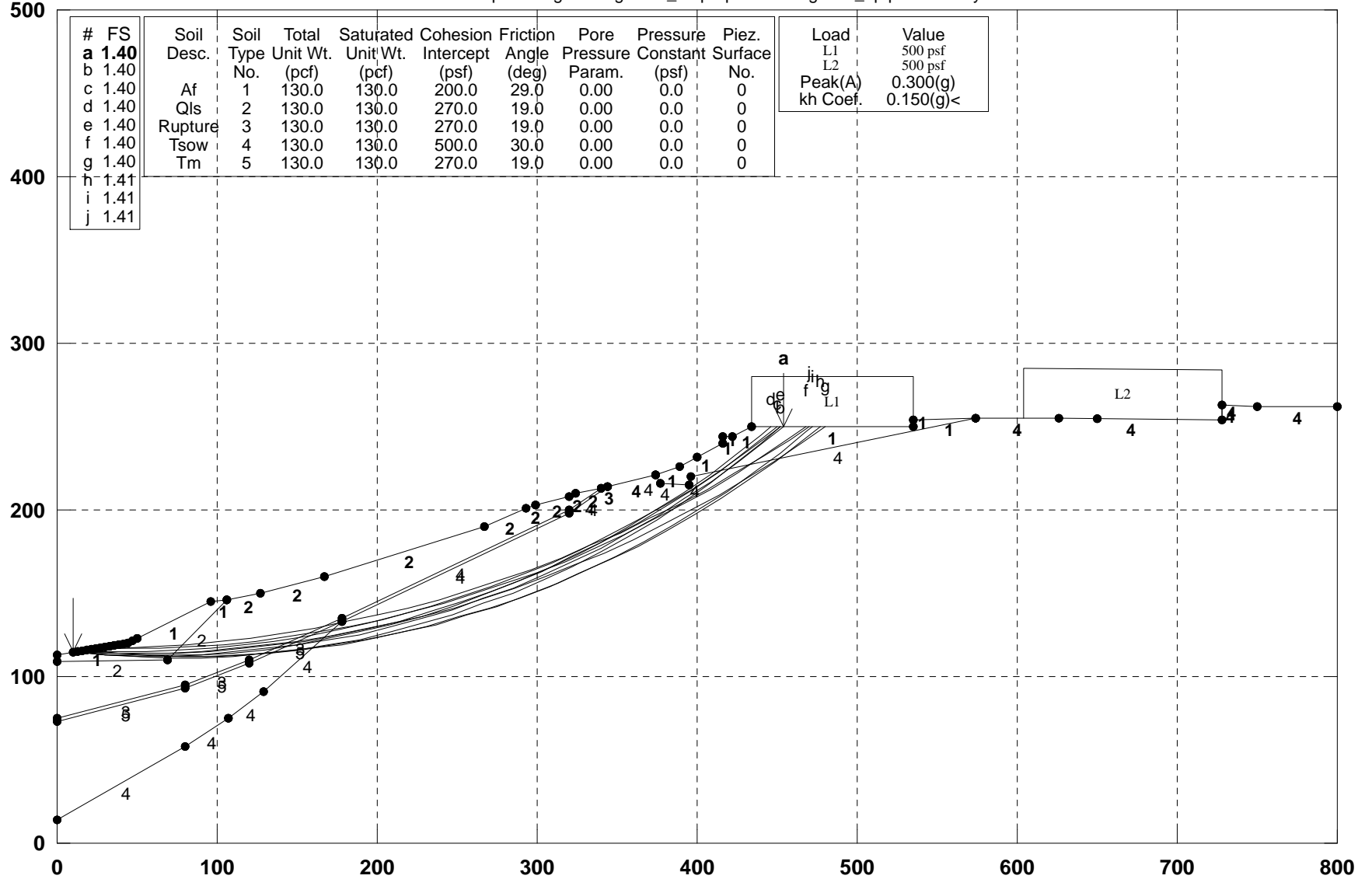

#	FS	Soil Desc.	Soil Type	Total Unit Wt. (pcf)	Saturated Unit Wt. (pcf)	Cohesion Intercept (psf)	Friction Angle (deg)	Pore Pressure Param.	Pressure Constant (psf)	Piez. Surface No.
a	1.40									
b	1.40									
c	1.40	Af	1	130.0	130.0	200.0	29.0	0.00	0.0	0
d	1.40	Qls	2	130.0	130.0	270.0	19.0	0.00	0.0	0
e	1.40	Rupture	3	130.0	130.0	270.0	19.0	0.00	0.0	0
f	1.40	Tsow	4	130.0	130.0	500.0	30.0	0.00	0.0	0
g	1.40	Tm	5	130.0	130.0	270.0	19.0	0.00	0.0	0
h	1.41									
i	1.41									
j	1.41									

Load	Value
L1	500 psf
L2	500 psf
Peak(A)	0.300(g)
kh Coef.	0.150(g)<

GSTABL7 v.2 FSmin=1.40
 Safety Factors Are Calculated By The Modified Bishop Method

*** GSTABL7 ***

** GSTABL7 by Dr. Garry H. Gregory, Ph.D.,P.E.,D.GE **

** Original Version 1.0, January 1996; Current Ver. 2.005.2, Jan. 2011 **
(All Rights Reserved-Unauthorizd Use Prohibited)

SLOPE STABILITY ANALYSIS SYSTEM

Modified Bishop, Simplified Janbu, or GLE Method of Slices.
(Includes Spencer & Morgenstern-Price Type Analysis)
Including Pier/Pile, Reinforcement, Soil Nail, Tieback,
Nonlinear Undrained Shear Strength, Curved Phi Envelope,
Anisotropic Soil, Fiber-Reinforced Soil, Boundary Loads, Water
Surfaces, Pseudo-Static & Newmark Earthquake, and Applied Forces.

Analysis Run Date: 10/19/2012
Time of Run: 03:56PM
Run By: Username
Input Data Filename: Z:\2010\10132-01 South Shores Church - Dana Point\Engineerin
g\2012_10\Proposed Design\dd'_2p.
Output Filename: Z:\2010\10132-01 South Shores Church - Dana Point\Engineerin
g\2012_10\Proposed Design\dd'_2p.OUT
Unit System: English
Plotted Output Filename: Z:\2010\10132-01 South Shores Church - Dana Point\Engineerin
g\2012_10\Proposed Design\dd'_2p.PLT
PROBLEM DESCRIPTION: D-D' / Design / Search Within Tsow /
Pseudostatic

BOUNDARY COORDINATES

26 Top Boundaries
46 Total Boundaries

Boundary No.	X-Left (ft)	Y-Left (ft)	X-Right (ft)	Y-Right (ft)	Soil Type Below Bnd
1	0.00	113.00	44.00	120.00	1
2	44.00	120.00	96.00	145.00	1
3	96.00	145.00	106.00	146.00	1
4	106.00	146.00	127.00	150.00	2
5	127.00	150.00	167.00	160.00	2
6	167.00	160.00	267.00	190.00	2
7	267.00	190.00	293.00	201.00	2
8	293.00	201.00	299.00	203.00	2
9	299.00	203.00	320.00	208.00	2
10	320.00	208.00	324.00	210.00	2
11	324.00	210.00	340.00	213.00	2
12	340.00	213.00	344.00	214.00	3
13	344.00	214.00	374.00	221.00	4
14	374.00	221.00	389.00	226.00	1
15	389.00	226.00	416.00	240.00	1
16	416.00	240.00	416.10	244.00	1
17	416.10	244.00	422.00	244.00	1
18	422.00	244.00	434.00	250.00	1
19	434.00	250.00	535.00	250.00	1
20	535.00	250.00	535.10	254.00	1
21	535.10	254.00	574.00	255.00	1
22	574.00	255.00	626.00	255.00	4
23	626.00	255.00	728.00	254.00	4
24	728.00	254.00	728.10	263.00	4
25	728.10	263.00	750.00	262.00	4
26	750.00	262.00	800.00	262.00	4
27	0.00	109.00	69.00	110.00	2
28	69.00	110.00	106.00	146.00	2
29	0.00	75.00	80.00	95.00	3
30	80.00	95.00	120.00	110.00	3
31	120.00	110.00	178.00	135.00	3
32	178.00	135.00	320.00	200.00	4
33	320.00	200.00	340.00	213.00	4
34	0.00	73.00	80.00	93.00	5
35	80.00	93.00	120.00	108.00	5
36	120.00	108.00	178.00	133.00	5
37	178.00	133.00	320.00	198.00	4
38	320.00	198.00	344.00	214.00	4
39	0.00	14.00	80.00	58.00	4
40	80.00	58.00	107.00	75.00	4

41	107.00	75.00	129.00	91.00	4
42	129.00	91.00	178.00	133.00	4
43	374.00	221.00	377.00	216.00	4
44	377.00	216.00	395.00	215.00	4
45	395.00	215.00	396.00	220.00	4
46	396.00	220.00	574.00	255.00	4

Default Y-Origin = 0.00(ft)
Default X-Plus Value = 0.00(ft)
Default Y-Plus Value = 0.00(ft)

ISOTROPIC SOIL PARAMETERS

5 Type(s) of Soil						
Soil No.	Total Unit Wt. (pcf)	Saturated Unit Wt. (pcf)	Cohesion (psf)	Friction Angle (deg)	Pore Pressure Param. (psf)	Piez. Constant Surface
1	130.00	130.00	200.0	29.0	0.00	0.0
2	130.00	130.00	270.0	19.0	0.00	0.0
3	130.00	130.00	270.0	19.0	0.00	0.0
4	130.00	130.00	500.0	30.0	0.00	0.0
5	130.00	130.00	270.0	19.0	0.00	0.0

BOUNDARY LOAD(S)

2 Load(s) Specified				
Load No.	X-Left (ft)	X-Right (ft)	Intensity (psf)	Deflection (deg)
1	434.00	535.00	500.0	0.0
2	604.00	728.00	500.0	0.0

NOTE - Intensity Is Specified As A Uniformly Distributed

Force Acting On A Horizontally Projected Surface.

Specified Peak Ground Acceleration Coefficient (A) = 0.300(g)

Specified Horizontal Earthquake Coefficient (kh) = 0.150(g)

Specified Vertical Earthquake Coefficient (kv) = 0.000(g)

Specified Seismic Pore-Pressure Factor = 0.000

A Critical Failure Surface Searching Method, Using A Random

Technique For Generating Circular Surfaces, Has Been Specified.

1500 Trial Surfaces Have Been Generated.

100 Surface(s) Initiate(s) From Each Of 15 Points Equally Spaced

Along The Ground Surface Between X = 10.00(ft)

and X = 50.00(ft)

Each Surface Terminates Between X = 400.00(ft)

and X = 650.00(ft)

Unless Further Limitations Were Imposed, The Minimum Elevation

At Which A Surface Extends Is Y = 0.00(ft)

20.00(ft) Line Segments Define Each Trial Failure Surface.

Following Are Displayed The Ten Most Critical Of The Trial

Failure Surfaces Evaluated. They Are

Ordered - Most Critical First.

* * Safety Factors Are Calculated By The Modified Bishop Method * *

Total Number of Trial Surfaces Attempted = 1500

Number of Trial Surfaces With Valid FS = 1500

Statistical Data On All Valid FS Values:

FS Max = 2.467 FS Min = 1.397 FS Ave = 1.909

Standard Deviation = 0.296 Coefficient of Variation = 15.53 %

Failure Surface Specified By 25 Coordinate Points

Point No.	X-Surf (ft)	Y-Surf (ft)
1	10.000	114.591
2	29.954	113.238
3	49.941	112.523
4	69.941	112.448
5	89.933	113.012
6	109.897	114.215
7	129.812	116.056
8	149.658	118.532
9	169.415	121.641
10	189.063	125.380
11	208.580	129.746
12	227.949	134.733
13	247.148	140.337
14	266.158	146.551
15	284.959	153.370
16	303.533	160.787

17	321.861	168.793
18	339.923	177.381
19	357.701	186.543
20	375.178	196.267
21	392.334	206.546
22	409.154	217.368
23	425.619	228.722
24	441.712	240.596
25	453.640	250.000

Circle Center At X = 62.294 ; Y = 737.983 ; and Radius = 625.581

Factor of Safety

*** 1.397 ***

Individual data on the

Slice No.	Width (ft)	Weight (lbs)	Water Force		Tie Force		Earthquake Force		Surcharge (lbs)
			Top (lbs)	Bot (lbs)	Norm (lbs)	Tan (lbs)	Hor (lbs)	Ver (lbs)	
1	20.0	5872.4	0.0	0.0	0.0	0.0	880.9	0.0	0.0
2	14.0	10765.7	0.0	0.0	0.0	0.0	1614.8	0.0	0.0
3	5.9	6795.9	0.0	0.0	0.0	0.0	1019.4	0.0	0.0
4	20.0	39463.4	0.0	0.0	0.0	0.0	5919.5	0.0	0.0
5	1.6	4299.4	0.0	0.0	0.0	0.0	644.9	0.0	0.0
6	18.4	59498.2	0.0	0.0	0.0	0.0	8924.7	0.0	0.0
7	6.1	23933.4	0.0	0.0	0.0	0.0	3590.0	0.0	0.0
8	10.0	41367.1	0.0	0.0	0.0	0.0	6205.1	0.0	0.0
9	3.9	16350.4	0.0	0.0	0.0	0.0	2452.6	0.0	0.0
10	17.1	74184.4	0.0	0.0	0.0	0.0	11127.7	0.0	0.0
11	2.8	12585.8	0.0	0.0	0.0	0.0	1887.9	0.0	0.0
12	6.0	27148.2	0.0	0.0	0.0	0.0	4072.2	0.0	0.0
13	6.5	30394.4	0.0	0.0	0.0	0.0	4559.2	0.0	0.0
14	7.4	35053.6	0.0	0.0	0.0	0.0	5258.0	0.0	0.0
15	14.0	68961.4	0.0	0.0	0.0	0.0	10344.2	0.0	0.0
16	3.3	16561.6	0.0	0.0	0.0	0.0	2484.2	0.0	0.0
17	2.4	12217.2	0.0	0.0	0.0	0.0	1832.6	0.0	0.0
18	8.6	44143.4	0.0	0.0	0.0	0.0	6621.5	0.0	0.0
19	11.1	58433.7	0.0	0.0	0.0	0.0	8765.1	0.0	0.0
20	19.5	106524.8	0.0	0.0	0.0	0.0	15978.7	0.0	0.0
21	19.4	108621.0	0.0	0.0	0.0	0.0	16293.2	0.0	0.0
22	19.2	108893.7	0.0	0.0	0.0	0.0	16334.1	0.0	0.0
23	19.0	107382.8	0.0	0.0	0.0	0.0	16107.4	0.0	0.0
24	0.8	4728.2	0.0	0.0	0.0	0.0	709.2	0.0	0.0
25	18.0	101992.5	0.0	0.0	0.0	0.0	15298.9	0.0	0.0
26	8.0	46332.1	0.0	0.0	0.0	0.0	6949.8	0.0	0.0
27	6.0	34492.7	0.0	0.0	0.0	0.0	5173.9	0.0	0.0
28	4.5	25728.3	0.0	0.0	0.0	0.0	3859.2	0.0	0.0
29	16.5	89173.0	0.0	0.0	0.0	0.0	13376.0	0.0	0.0
30	1.9	9694.4	0.0	0.0	0.0	0.0	1454.2	0.0	0.0
31	2.1	11170.1	0.0	0.0	0.0	0.0	1675.5	0.0	0.0
32	15.9	78445.4	0.0	0.0	0.0	0.0	11766.8	0.0	0.0
33	0.1	357.1	0.0	0.0	0.0	0.0	53.6	0.0	0.0
34	4.0	18225.1	0.0	0.0	0.0	0.0	2733.8	0.0	0.0
35	13.7	58041.0	0.0	0.0	0.0	0.0	8706.1	0.0	0.0
36	16.3	59372.4	0.0	0.0	0.0	0.0	8905.9	0.0	0.0
37	1.2	3866.8	0.0	0.0	0.0	0.0	580.0	0.0	0.0
38	1.8	5894.7	0.0	0.0	0.0	0.0	884.2	0.0	0.0
39	12.0	35952.1	0.0	0.0	0.0	0.0	5392.8	0.0	0.0
40	3.3	9240.4	0.0	0.0	0.0	0.0	1386.1	0.0	0.0
41	2.7	7282.9	0.0	0.0	0.0	0.0	1092.4	0.0	0.0
42	1.0	2702.4	0.0	0.0	0.0	0.0	405.4	0.0	0.0
43	13.2	34035.1	0.0	0.0	0.0	0.0	5105.3	0.0	0.0
44	6.8	16462.5	0.0	0.0	0.0	0.0	2469.4	0.0	0.0
45	0.1	258.4	0.0	0.0	0.0	0.0	38.8	0.0	0.0
46	3.6	9742.6	0.0	0.0	0.0	0.0	1461.4	0.0	0.0
47	2.3	5450.1	0.0	0.0	0.0	0.0	817.5	0.0	0.0
48	3.6	8199.6	0.0	0.0	0.0	0.0	1229.9	0.0	0.0
49	8.4	17532.6	0.0	0.0	0.0	0.0	2629.9	0.0	0.0
50	7.7	12280.5	0.0	0.0	0.0	0.0	1842.1	0.0	3856.0
51	11.9	7291.0	0.0	0.0	0.0	0.0	1093.6	0.0	5963.8

Failure Surface Specified By 25 Coordinate Points

Point X-Surf Y-Surf

No.	(ft)	(ft)
1	15.714	115.500
2	35.708	114.992
3	55.708	115.067
4	75.697	115.723
5	95.659	116.961
6	115.576	118.778
7	135.432	121.175
8	155.209	124.148
9	174.892	127.696
10	194.464	131.815
11	213.907	136.501
12	233.205	141.752
13	252.343	147.561
14	271.303	153.925
15	290.071	160.838
16	308.629	168.294
17	326.962	176.287
18	345.055	184.810
19	362.893	193.856
20	380.459	203.417
21	397.741	213.485
22	414.721	224.051
23	431.387	235.108
24	447.725	246.644
25	452.195	250.000

Circle Center At X = 43.153 ; Y = 802.240 ; and Radius = 687.288

Factor of Safety

*** 1.400 ***

Failure Surface Specified By 25 Coordinate Points

Point No.	X-Surf (ft)	Y-Surf (ft)
1	15.714	115.500
2	35.687	114.462
3	55.683	114.055
4	75.682	114.281
5	95.664	115.138
6	115.608	116.626
7	135.496	118.743
8	155.306	121.488
9	175.021	124.857
10	194.619	128.848
11	214.081	133.455
12	233.387	138.675
13	252.519	144.503
14	271.458	150.932
15	290.184	157.956
16	308.679	165.569
17	326.923	173.762
18	344.900	182.527
19	362.591	191.856
20	379.979	201.739
21	397.045	212.166
22	413.774	223.128
23	430.148	234.612
24	446.151	246.608
25	450.390	250.000

Circle Center At X = 58.549 ; Y = 746.999 ; and Radius = 632.950

Factor of Safety

*** 1.400 ***

Failure Surface Specified By 25 Coordinate Points

Point No.	X-Surf (ft)	Y-Surf (ft)
1	10.000	114.591
2	29.961	113.345
3	49.952	112.747
4	69.952	112.799
5	89.940	113.499
6	109.894	114.847
7	129.795	116.842

8	149.620	119.481
9	169.349	122.763
10	188.961	126.683
11	208.435	131.236
12	227.752	136.420
13	246.890	142.227
14	265.830	148.652
15	284.552	155.689
16	303.035	163.329
17	321.260	171.565
18	339.209	180.387
19	356.862	189.788
20	374.201	199.756
21	391.208	210.281
22	407.863	221.353
23	424.151	232.959
24	440.054	245.088
25	446.079	250.000

Circle Center At X = 58.372 ; Y = 729.053 ; and Radius = 616.364

Factor of Safety

*** 1.401 ***

Failure Surface Specified By 25 Coordinate Points

Point No.	X-Surf (ft)	Y-Surf (ft)
1	10.000	114.591
2	29.913	112.724
3	49.878	111.541
4	69.871	111.044
5	89.871	111.233
6	109.851	112.109
7	129.790	113.669
8	149.664	115.913
9	169.449	118.838
10	189.122	122.439
11	208.660	126.714
12	228.040	131.656
13	247.239	137.260
14	266.234	143.520
15	285.003	150.428
16	303.524	157.976
17	321.775	166.155
18	339.735	174.956
19	357.382	184.367
20	374.696	194.379
21	391.656	204.978
22	408.242	216.154
23	424.436	227.892
24	440.217	240.178
25	451.976	250.000

Circle Center At X = 74.354 ; Y = 693.813 ; and Radius = 582.786

Factor of Safety

*** 1.402 ***

Failure Surface Specified By 25 Coordinate Points

Point No.	X-Surf (ft)	Y-Surf (ft)
1	24.286	116.864
2	44.285	116.673
3	64.282	117.015
4	84.263	117.890
5	104.213	119.298
6	124.119	121.237
7	143.966	123.707
8	163.740	126.704
9	183.427	130.228
10	203.013	134.276
11	222.484	138.844
12	241.827	143.930
13	261.027	149.530
14	280.071	155.639
15	298.945	162.254

16	317.637	169.371
17	336.131	176.983
18	354.417	185.085
19	372.479	193.672
20	390.307	202.738
21	407.886	212.276
22	425.205	222.279
23	442.250	232.740
24	459.011	243.652
25	468.215	250.000

Circle Center At X = 41.447 ; Y = 866.697 ; and Radius = 750.030

Factor of Safety

*** 1.403 ***

Failure Surface Specified By 26 Coordinate Points

Point No.	X-Surf (ft)	Y-Surf (ft)
1	10.000	114.591
2	29.990	113.965
3	49.990	113.862
4	69.986	114.280
5	89.963	115.220
6	109.910	116.680
7	129.812	118.661
8	149.655	121.160
9	169.426	124.176
10	189.112	127.707
11	208.699	131.750
12	228.174	136.303
13	247.524	141.362
14	266.734	146.925
15	285.794	152.987
16	304.688	159.544
17	323.405	166.592
18	341.932	174.126
19	360.256	182.141
20	378.364	190.631
21	396.245	199.590
22	413.886	209.013
23	431.275	218.894
24	448.401	229.224
25	465.251	239.998
26	480.030	250.000

Circle Center At X = 43.991 ; Y = 880.086 ; and Radius = 766.250

Factor of Safety

*** 1.403 ***

Failure Surface Specified By 26 Coordinate Points

Point No.	X-Surf (ft)	Y-Surf (ft)
1	12.857	115.045
2	32.787	113.374
3	52.759	112.318
4	72.754	111.879
5	92.754	112.057
6	112.738	112.852
7	132.688	114.264
8	152.585	116.290
9	172.410	118.930
10	192.144	122.180
11	211.769	126.038
12	231.265	130.500
13	250.614	135.561
14	269.797	141.217
15	288.797	147.462
16	307.595	154.290
17	326.174	161.696
18	344.515	169.671
19	362.601	178.208
20	380.415	187.300
21	397.941	196.937
22	415.160	207.110

23 432.057 217.809
 24 448.616 229.026
 25 464.821 240.747
 26 476.815 250.000
 Circle Center At X = 77.015 ; Y = 759.473 ; and Radius = 647.613
 Factor of Safety

*** 1.405 ***

Failure Surface Specified By 26 Coordinate Points

Point No.	X-Surf (ft)	Y-Surf (ft)
1	18.571	115.955
2	38.483	114.080
3	58.446	112.859
4	78.438	112.293
5	98.438	112.383
6	118.424	113.129
7	138.375	114.529
8	158.269	116.583
9	178.085	119.287
10	197.802	122.640
11	217.399	126.637
12	236.854	131.275
13	256.146	136.548
14	275.255	142.450
15	294.161	148.976
16	312.842	156.118
17	331.279	163.868
18	349.453	172.219
19	367.342	181.161
20	384.929	190.685
21	402.194	200.780
22	419.119	211.436
23	435.686	222.640
24	451.876	234.382
25	467.673	246.648
26	471.709	250.000

Circle Center At X = 85.731 ; Y = 721.856 ; and Radius = 609.613
 Factor of Safety

*** 1.408 ***

Failure Surface Specified By 25 Coordinate Points

Point No.	X-Surf (ft)	Y-Surf (ft)
1	21.429	116.409
2	41.425	116.764
3	61.408	117.596
4	81.365	118.906
5	101.285	120.692
6	121.157	122.953
7	140.969	125.688
8	160.710	128.896
9	180.369	132.575
10	199.934	136.722
11	219.395	141.335
12	238.740	146.412
13	257.958	151.949
14	277.038	157.944
15	295.970	164.393
16	314.742	171.292
17	333.345	178.638
18	351.766	186.426
19	369.996	194.652
20	388.024	203.312
21	405.840	212.399
22	423.435	221.909
23	440.797	231.837
24	457.916	242.177
25	470.197	250.000

Circle Center At X = 16.575 ; Y = 953.573 ; and Radius = 837.178
 Factor of Safety

*** 1.408 ***

**** END OF GSTABL7 OUTPUT ****

E-E' / Design / Search Within Tsow /

z:\2010\10132-01 south shores church - dana point\engineering\2012_10\proposed design\ee'_1.pl2 5/10/2012 07:56AM

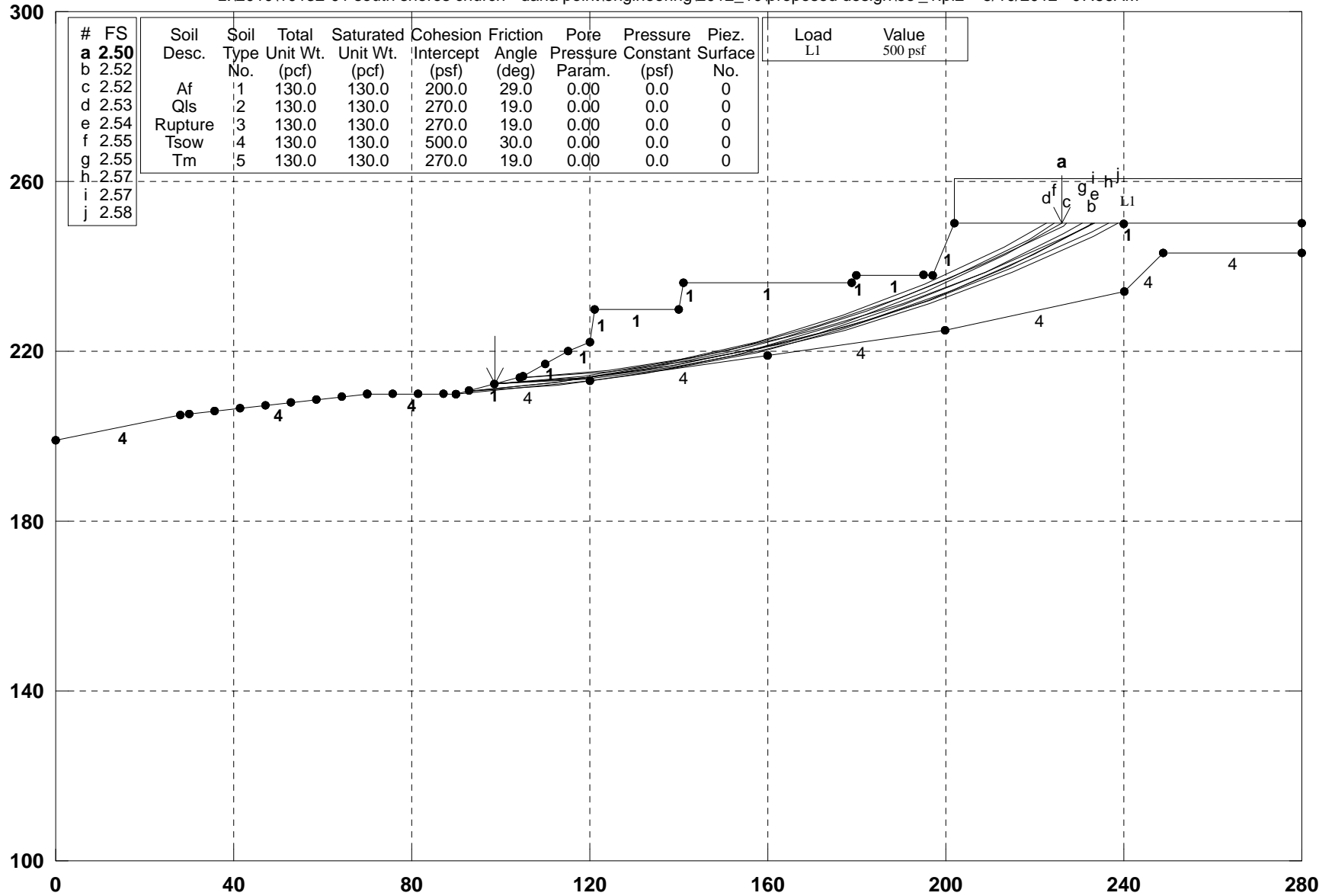

#	FS	Soil Desc.	Soil No.	Soil Type	Total Unit Wt. (pcf)	Saturated Unit Wt. (pcf)	Cohesion Intercept (psf)	Friction Angle (deg)	Pore Pressure Param.	Pressure Constant (psf)	Piez. Surface No.
a	2.50										
b	2.52										
c	2.52	Af	1		130.0	130.0	200.0	29.0	0.00	0.0	0
d	2.53	Qls	2		130.0	130.0	270.0	19.0	0.00	0.0	0
e	2.54	Rupture	3		130.0	130.0	270.0	19.0	0.00	0.0	0
f	2.55	Tsow	4		130.0	130.0	500.0	30.0	0.00	0.0	0
g	2.55	Tm	5		130.0	130.0	270.0	19.0	0.00	0.0	0

Load L1	Value
	500 psf

h	2.57
i	2.57
j	2.58

GSTABL7 v.2 FSmin=2.50

Safety Factors Are Calculated By The Modified Bishop Method

*** GSTABL7 ***

** GSTABL7 by Dr. Garry H. Gregory, Ph.D., P.E., D.GE **

** Original Version 1.0, January 1996; Current Ver. 2.005.2, Jan. 2011 **
(All Rights Reserved-Unauthorizd Use Prohibited)

SLOPE STABILITY ANALYSIS SYSTEM

Modified Bishop, Simplified Janbu, or GLE Method of Slices.
(Includes Spencer & Morgenstern-Price Type Analysis)
Including Pier/Pile, Reinforcement, Soil Nail, Tieback,
Nonlinear Undrained Shear Strength, Curved Phi Envelope,
Anisotropic Soil, Fiber-Reinforced Soil, Boundary Loads, Water
Surfaces, Pseudo-Static & Newmark Earthquake, and Applied Forces.

Analysis Run Date: 5/10/2012

Time of Run: 07:56AM

Run By:

Input Data Filename: Z:\2010\10132-01 South Shores Church - Dana Point\Engineerin
g\2012_05\ee'_1.

Output Filename: Z:\2010\10132-01 South Shores Church - Dana Point\Engineerin
g\2012_05\ee'_1.OUT

Unit System: English

Plotted Output Filename: Z:\2010\10132-01 South Shores Church - Dana Point\Engineerin
g\2012_05\ee'_1.PLT

PROBLEM DESCRIPTION: E-E' / Design / Search Within Tsow /

BOUNDARY COORDINATES

14 Top Boundaries
20 Total Boundaries

Boundary No.	X-Left (ft)	Y-Left (ft)	X-Right (ft)	Y-Right (ft)	Soil Type Below Bnd
1	0.00	199.00	28.00	205.00	4
2	28.00	205.00	70.00	210.00	4
3	70.00	210.00	90.00	210.00	4
4	90.00	210.00	105.00	214.00	1
5	105.00	214.00	115.00	220.00	1
6	115.00	220.00	120.00	222.00	1
7	120.00	222.00	121.00	230.00	1
8	121.00	230.00	140.00	230.00	1
9	140.00	230.00	141.00	236.00	1
10	141.00	236.00	179.00	236.00	1
11	179.00	236.00	180.00	238.00	1
12	180.00	238.00	197.00	238.00	1
13	197.00	238.00	202.00	250.00	1
14	202.00	250.00	280.00	250.00	1
15	90.00	210.00	120.00	213.00	4
16	120.00	213.00	160.00	219.00	4
17	160.00	219.00	200.00	225.00	4
18	200.00	225.00	240.00	234.00	4
19	240.00	234.00	249.00	243.00	4
20	249.00	243.00	280.00	243.00	4

User Specified Y-Origin = 100.00(ft)

Default X-Plus Value = 0.00(ft)

Default Y-Plus Value = 0.00(ft)

ISOTROPIC SOIL PARAMETERS

5 Type(s) of Soil

Soil Type No.	Total Unit Wt. (pcf)	Saturated Unit Wt. (pcf)	Cohesion (psf)	Friction Angle (deg)	Pore Pressure Param. (psf)	Piez. Constant Surface No.
1	130.0	130.0	200.0	29.0	0.00	0
2	130.0	130.0	270.0	19.0	0.00	0
3	130.0	130.0	270.0	19.0	0.00	0
4	130.0	130.0	500.0	30.0	0.00	0
5	130.0	130.0	270.0	19.0	0.00	0

BOUNDARY LOAD(S)

1 Load(s) Specified

Load No.	X-Left (ft)	X-Right (ft)	Intensity (psf)	Deflection (deg)
1	202.00	280.00	500.0	0.0

NOTE - Intensity Is Specified As A Uniformly Distributed Force Acting On A Horizontally Projected Surface.

A Critical Failure Surface Searching Method, Using A Random

Technique For Generating Circular Surfaces, Has Been Specified.

1500 Trial Surfaces Have Been Generated.

100 Surface(s) Initiate(s) From Each Of 15 Points Equally Spaced

Along The Ground Surface Between X = 30.00(ft)

and X = 110.00(ft)

Each Surface Terminates Between X = 195.00(ft)

and X = 240.00(ft)

Unless Further Limitations Were Imposed, The Minimum Elevation

At Which A Surface Extends Is Y = 0.00(ft)

20.00(ft) Line Segments Define Each Trial Failure Surface.

Following Are Displayed The Ten Most Critical Of The Trial

Failure Surfaces Evaluated. They Are

Ordered - Most Critical First.

* * Safety Factors Are Calculated By The Modified Bishop Method * *

Total Number of Trial Surfaces Attempted = 1500

Number of Trial Surfaces With Valid FS = 1500

Statistical Data On All Valid FS Values:

FS Max = 7.910 FS Min = 2.503 FS Ave = 3.723

Standard Deviation = 0.611 Coefficient of Variation = 16.42 %

Failure Surface Specified By 8 Coordinate Points

Point No.	X-Surf (ft)	Y-Surf (ft)
1	98.571	212.286
2	118.530	213.577
3	138.329	216.407
4	157.849	220.758
5	176.976	226.605
6	195.593	233.913
7	213.590	242.637
8	226.192	250.000

Circle Center At X = 92.157 ; Y = 468.776 ; and Radius = 256.570

Factor of Safety *** 2.503 ***

Individual data on the 17 slices

Slice No.	Width (ft)	Weight (lbs)	Water Force Top (lbs)	Water Force Bot (lbs)	Tie Norm (lbs)	Tie Force (lbs)	Earthquake Force (lbs)	Surcharge Hor (lbs)	Surcharge Ver (lbs)	Surcharge Load (lbs)
1	6.4	542.5	0.0	0.0	0.0	0.0	0.0	0.0	0.0	0.0
2	10.0	5167.4	0.0	0.0	0.0	0.0	0.0	0.0	0.0	0.0
3	3.5	3323.6	0.0	0.0	0.0	0.0	0.0	0.0	0.0	0.0
4	1.5	1533.7	0.0	0.0	0.0	0.0	0.0	0.0	0.0	0.0
5	1.0	1578.4	0.0	0.0	0.0	0.0	0.0	0.0	0.0	0.0
6	17.3	33411.3	0.0	0.0	0.0	0.0	0.0	0.0	0.0	0.0
7	1.7	2913.2	0.0	0.0	0.0	0.0	0.0	0.0	0.0	0.0
8	1.0	2094.2	0.0	0.0	0.0	0.0	0.0	0.0	0.0	0.0
9	16.8	37499.7	0.0	0.0	0.0	0.0	0.0	0.0	0.0	0.0
10	19.1	30628.7	0.0	0.0	0.0	0.0	0.0	0.0	0.0	0.0
11	2.0	2367.9	0.0	0.0	0.0	0.0	0.0	0.0	0.0	0.0
12	1.0	1222.5	0.0	0.0	0.0	0.0	0.0	0.0	0.0	0.0
13	15.6	14488.7	0.0	0.0	0.0	0.0	0.0	0.0	0.0	0.0
14	1.4	685.3	0.0	0.0	0.0	0.0	0.0	0.0	0.0	0.0
15	5.0	5325.6	0.0	0.0	0.0	0.0	0.0	0.0	0.0	0.0
16	11.6	15325.8	0.0	0.0	0.0	0.0	0.0	0.0	0.0	5794.8
17	12.6	6031.3	0.0	0.0	0.0	0.0	0.0	0.0	0.0	6301.2

Failure Surface Specified By 9 Coordinate Points

Point No.	X-Surf (ft)	Y-Surf (ft)
1	98.571	212.286
2	118.545	213.314
3	138.389	215.809
4	157.995	219.757
5	177.258	225.137
6	196.073	231.920
7	214.337	240.068
8	231.953	249.539
9	232.678	250.000

Circle Center At X = 94.602 ; Y = 483.908 ; and Radius = 271.651

Factor of Safety *** 2.520 ***

Failure Surface Specified By 9 Coordinate Points

Point No.	X-Surf (ft)	Y-Surf (ft)
1	92.857	210.762
2	112.751	212.817
3	132.487	216.057
4	151.994	220.472
5	171.202	226.044
6	190.043	232.754
7	208.448	240.579
8	226.354	249.490
9	227.242	250.000

Circle Center At X = 68.451 ; Y = 544.341 ; and Radius = 334.470

Factor of Safety
*** 2.521 ***

Failure Surface Specified By 8 Coordinate Points

Point No.	X-Surf (ft)	Y-Surf (ft)
1	98.571	212.286
2	118.480	214.198
3	138.200	217.531
4	157.631	222.268
5	176.672	228.386
6	195.227	235.852
7	213.198	244.627
8	222.454	250.000

Circle Center At X = 82.374 ; Y = 487.808 ; and Radius = 275.998

Factor of Safety
*** 2.528 ***

Failure Surface Specified By 9 Coordinate Points

Point No.	X-Surf (ft)	Y-Surf (ft)
1	92.857	210.762
2	112.758	212.754
3	132.521	215.822
4	152.089	219.955
5	171.405	225.142
6	190.411	231.367
7	209.053	238.613
8	227.274	246.857
9	233.324	250.000

Circle Center At X = 66.047 ; Y = 578.931 ; and Radius = 369.144

Factor of Safety
*** 2.544 ***

Failure Surface Specified By 8 Coordinate Points

Point No.	X-Surf (ft)	Y-Surf (ft)
1	104.286	213.810
2	124.226	215.348
3	143.979	218.483
4	163.416	223.194
5	182.412	229.452
6	200.844	237.215
7	218.593	246.433
8	224.290	250.000

Circle Center At X = 95.548 ; Y = 459.840 ; and Radius = 246.186

Factor of Safety
*** 2.552 ***

Failure Surface Specified By 9 Coordinate Points

Point No.	X-Surf (ft)	Y-Surf (ft)
1	92.857	210.762
2	112.808	212.159
3	132.623	214.878
4	152.212	218.908
5	171.491	224.231
6	190.373	230.823
7	208.776	238.655
8	226.618	247.692
9	230.509	250.000

Circle Center At X = 81.831 ; Y = 511.401 ; and Radius = 300.841

Factor of Safety
*** 2.553 ***

Failure Surface Specified By 9 Coordinate Points

Point No.	X-Surf (ft)	Y-Surf (ft)
1	98.571	212.286
2	118.507	213.895
3	138.310	216.692
4	157.911	220.667
5	177.240	225.805
6	196.227	232.088
7	214.805	239.495
8	232.908	247.997
9	236.584	250.000

Circle Center At X = 81.618 ; Y = 546.584 ; and Radius = 334.728

Factor of Safety
*** 2.569 ***

Failure Surface Specified By 8 Coordinate Points

Point No.	X-Surf (ft)	Y-Surf (ft)
1	104.286	213.810
2	124.246	215.074
3	144.060	217.792
4	163.624	221.948
5	182.832	227.520
6	201.582	234.478
7	219.775	242.786
8	232.938	250.000

Circle Center At X = 97.228 ; Y = 485.665 ; and Radius = 271.947

Factor of Safety
*** 2.574 ***

Failure Surface Specified By 9 Coordinate Points

Point No.	X-Surf (ft)	Y-Surf (ft)
1	98.571	212.286
2	118.526	213.639
3	138.359	216.218
4	157.995	220.016
5	177.360	225.015
6	196.380	231.199
7	214.983	238.543
8	233.098	247.019
9	238.563	250.000

Circle Center At X = 86.615 ; Y = 536.479 ; and Radius = 324.414

Factor of Safety
*** 2.575 ***

**** END OF GSTABL7 OUTPUT ****

E-E' / Design / Search Within Tsow / Pseudostatic

z:\2010\10132-01 south shores church - dana point\engineering\2012_10\proposed design\ee'_1p.pl2 5/10/2012 07:57AM

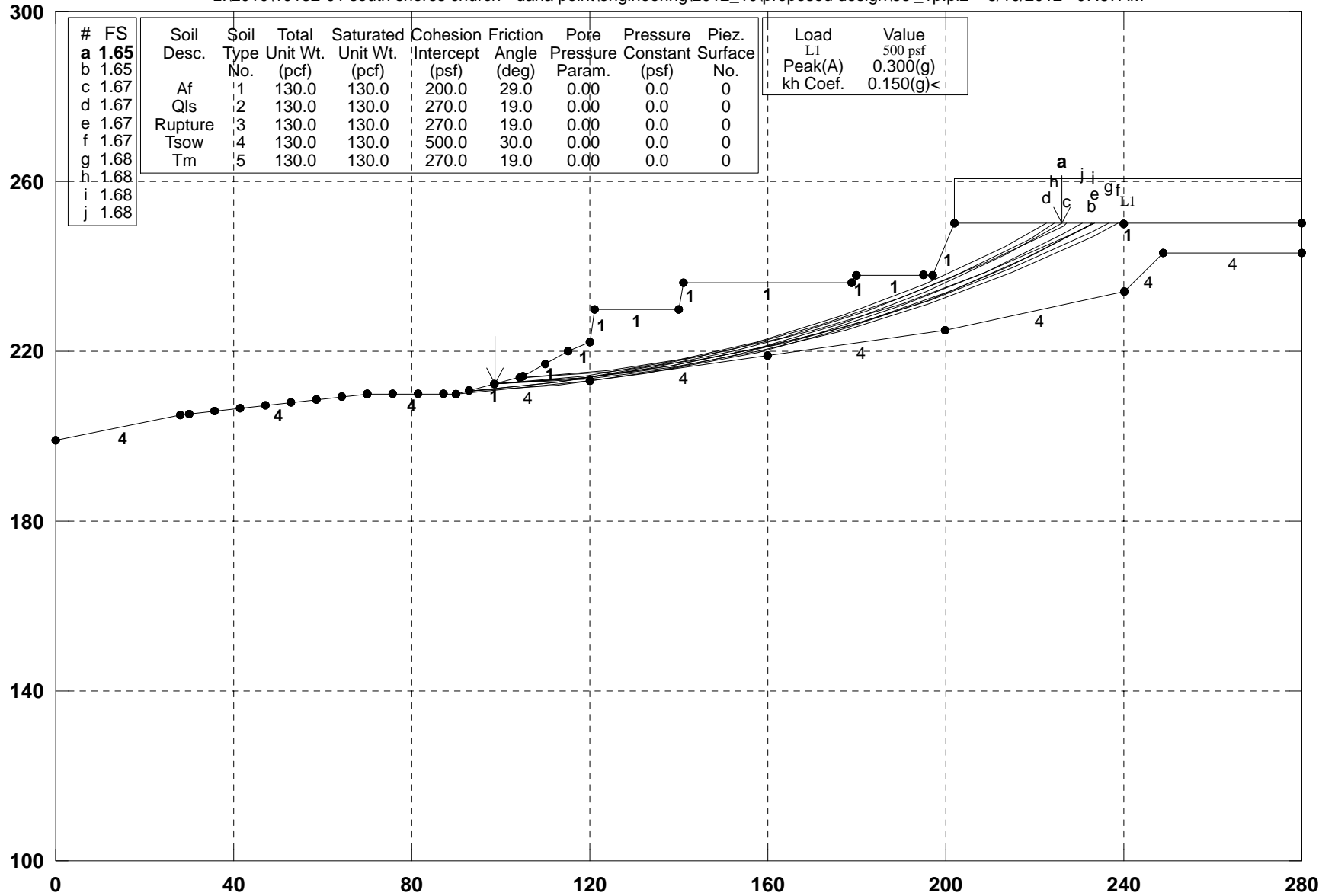

GSTABL7 v.2 FSmin=1.65

Safety Factors Are Calculated By The Modified Bishop Method

*** GSTABL7 ***

** GSTABL7 by Dr. Garry H. Gregory, Ph.D., P.E., D.GE **

** Original Version 1.0, January 1996; Current Ver. 2.005.2, Jan. 2011 **
 (All Rights Reserved-Unauthorized Use Prohibited)

SLOPE STABILITY ANALYSIS SYSTEM

Modified Bishop, Simplified Janbu, or GLE Method of Slices.
 (Includes Spencer & Morgenstern-Price Type Analysis)
 Including Pier/Pile, Reinforcement, Soil Nail, Tieback,
 Nonlinear Undrained Shear Strength, Curved Phi Envelope,
 Anisotropic Soil, Fiber-Reinforced Soil, Boundary Loads, Water
 Surfaces, Pseudo-Static & Newmark Earthquake, and Applied Forces.

Analysis Run Date: 5/10/2012
 Time of Run: 07:57AM
 Run By:
 Input Data Filename: Z:\2010\10132-01 South Shores Church - Dana Point\Engineerin
 g\2012_05\ee'_lp.
 Output Filename: Z:\2010\10132-01 South Shores Church - Dana Point\Engineerin
 g\2012_05\ee'_lp.OUT
 Unit System: English
 Plotted Output Filename: Z:\2010\10132-01 South Shores Church - Dana Point\Engineerin
 g\2012_05\ee'_lp.PLT

PROBLEM DESCRIPTION: E-E' / Design / Search Within Tsow /
 Pseudostatic

BOUNDARY COORDINATES

14 Top Boundaries					
20 Total Boundaries					
Boundary No.	X-Left (ft)	Y-Left (ft)	X-Right (ft)	Y-Right (ft)	Soil Type Below Bnd
1	0.00	199.00	28.00	205.00	4
2	28.00	205.00	70.00	210.00	4
3	70.00	210.00	90.00	210.00	4
4	90.00	210.00	105.00	214.00	1
5	105.00	214.00	115.00	220.00	1
6	115.00	220.00	120.00	222.00	1
7	120.00	222.00	121.00	230.00	1
8	121.00	230.00	140.00	230.00	1
9	140.00	230.00	141.00	236.00	1
10	141.00	236.00	179.00	236.00	1
11	179.00	236.00	180.00	238.00	1
12	180.00	238.00	197.00	238.00	1
13	197.00	238.00	202.00	250.00	1
14	202.00	250.00	280.00	250.00	1
15	90.00	210.00	120.00	213.00	4
16	120.00	213.00	160.00	219.00	4
17	160.00	219.00	200.00	225.00	4
18	200.00	225.00	240.00	234.00	4
19	240.00	234.00	249.00	243.00	4
20	249.00	243.00	280.00	243.00	4

User Specified Y-Origin = 100.00(ft)
 Default X-Plus Value = 0.00(ft)
 Default Y-Plus Value = 0.00(ft)

ISOTROPIC SOIL PARAMETERS

5 Type(s) of Soil							
Soil Type	Total Unit Wt. (pcf)	Saturated Unit Wt. (pcf)	Cohesion (psf)	Friction Angle (deg)	Pore Pressure Param. (psf)	Pressure Constant (psf)	Piez. Surface No.
1	130.0	130.0	200.0	29.0	0.00	0.0	0
2	130.0	130.0	270.0	19.0	0.00	0.0	0
3	130.0	130.0	270.0	19.0	0.00	0.0	0
4	130.0	130.0	500.0	30.0	0.00	0.0	0
5	130.0	130.0	270.0	19.0	0.00	0.0	0

BOUNDARY LOAD(S)

1 Load(s) Specified				
Load No.	X-Left (ft)	X-Right (ft)	Intensity (psf)	Deflection (deg)
1	202.00	280.00	500.0	0.0

NOTE - Intensity Is Specified As A Uniformly Distributed Force Acting On A Horizontally Projected Surface.

Specified Peak Ground Acceleration Coefficient (A) = 0.300(g)
 Specified Horizontal Earthquake Coefficient (kh) = 0.150(g)
 Specified Vertical Earthquake Coefficient (kv) = 0.000(g)
 Specified Seismic Pore-Pressure Factor = 0.000
 A Critical Failure Surface Searching Method, Using A Random Technique For Generating Circular Surfaces, Has Been Specified.
 1500 Trial Surfaces Have Been Generated.
 100 Surface(s) Initiate(s) From Each Of 15 Points Equally Spaced
 Along The Ground Surface Between X = 30.00(ft)
 and X = 110.00(ft)
 Each Surface Terminates Between X = 195.00(ft)
 and X = 240.00(ft)

Unless Further Limitations Were Imposed, The Minimum Elevation At Which A Surface Extends Is Y = 0.00(ft)
 20.00(ft) Line Segments Define Each Trial Failure Surface.
 Following Are Displayed The Ten Most Critical Of The Trial Failure Surfaces Evaluated. They Are

Ordered - Most Critical First.
 * * Safety Factors Are Calculated By The Modified Bishop Method * *
 Total Number of Trial Surfaces Attempted = 1500
 Number of Trial Surfaces With Valid FS = 1500
 Statistical Data on All Valid FS Values:
 FS Max = 4.444 FS Min = 1.647 FS Ave = 2.407
 Standard Deviation = 0.373 Coefficient of Variation = 15.49 %
 Failure Surface Specified By 8 Coordinate Points

Point No.	X-Surf (ft)	Y-Surf (ft)
1	98.571	212.286
2	118.530	213.577
3	138.329	216.407
4	157.849	220.758
5	176.976	226.605
6	195.593	233.913
7	213.590	242.637
8	226.192	250.000

Circle Center At X = 92.157 ; Y = 468.776 ; and Radius = 256.570

Factor of Safety
 *** 1.647 ***

Individual data on the 17 slices

Slice No.	Width (ft)	Weight (lbs)	Water Force (lbs)		Tie Norm (lbs)	Tie Tan (lbs)	Earthquake Force (lbs)		Surcharge Load (lbs)
			Top	Bot			Hor	Ver	
1	6.4	542.5	0.0	0.0	0.0	0.0	81.4	0.0	0.0
2	10.0	5167.4	0.0	0.0	0.0	0.0	775.1	0.0	0.0
3	3.5	3323.6	0.0	0.0	0.0	0.0	498.5	0.0	0.0
4	1.5	1533.7	0.0	0.0	0.0	0.0	230.1	0.0	0.0
5	1.0	1578.4	0.0	0.0	0.0	0.0	236.8	0.0	0.0
6	17.3	33411.3	0.0	0.0	0.0	0.0	5011.7	0.0	0.0
7	1.7	2913.2	0.0	0.0	0.0	0.0	437.0	0.0	0.0
8	1.0	2094.2	0.0	0.0	0.0	0.0	314.1	0.0	0.0
9	16.8	37499.7	0.0	0.0	0.0	0.0	5625.0	0.0	0.0
10	19.1	30628.7	0.0	0.0	0.0	0.0	4594.3	0.0	0.0
11	2.0	2367.9	0.0	0.0	0.0	0.0	355.2	0.0	0.0
12	1.0	1222.5	0.0	0.0	0.0	0.0	183.4	0.0	0.0
13	15.6	14488.7	0.0	0.0	0.0	0.0	2173.3	0.0	0.0
14	1.4	685.3	0.0	0.0	0.0	0.0	102.8	0.0	0.0
15	5.0	5325.6	0.0	0.0	0.0	0.0	798.8	0.0	0.0
16	11.6	15325.8	0.0	0.0	0.0	0.0	2298.9	0.0	5794.8
17	12.6	6031.3	0.0	0.0	0.0	0.0	904.7	0.0	6301.2

Failure Surface Specified By 9 Coordinate Points

Point No.	X-Surf (ft)	Y-Surf (ft)
1	98.571	212.286
2	118.545	213.314
3	138.389	215.809
4	157.995	219.757
5	177.258	225.137
6	196.073	231.920
7	214.337	240.068

8 231.953 249.539
 9 232.678 250.000
 Circle Center At X = 94.602 ; Y = 483.908 ; and Radius = 271.651
 Factor of Safety
 *** 1.649 ***

Failure Surface Specified By 9 Coordinate Points

Point No.	X-Surf (ft)	Y-Surf (ft)
1	92.857	210.762
2	112.751	212.817
3	132.487	216.057
4	151.994	220.472
5	171.202	226.044
6	190.043	232.754
7	208.448	240.579
8	226.354	249.490
9	227.242	250.000

Circle Center At X = 68.451 ; Y = 544.341 ; and Radius = 334.470
 Factor of Safety
 *** 1.667 ***

Failure Surface Specified By 8 Coordinate Points

Point No.	X-Surf (ft)	Y-Surf (ft)
1	98.571	212.286
2	118.480	214.198
3	138.200	217.531
4	157.631	222.268
5	176.672	228.386
6	195.227	235.852
7	213.198	244.627
8	222.454	250.000

Circle Center At X = 82.374 ; Y = 487.808 ; and Radius = 275.998
 Factor of Safety
 *** 1.671 ***

Failure Surface Specified By 9 Coordinate Points

Point No.	X-Surf (ft)	Y-Surf (ft)
1	92.857	210.762
2	112.758	212.754
3	132.521	215.822
4	152.089	219.955
5	171.405	225.142
6	190.411	231.367
7	209.053	238.613
8	227.274	246.857
9	233.324	250.000

Circle Center At X = 66.047 ; Y = 578.931 ; and Radius = 369.144
 Factor of Safety
 *** 1.671 ***

Failure Surface Specified By 9 Coordinate Points

Point No.	X-Surf (ft)	Y-Surf (ft)
1	98.571	212.286
2	118.526	213.639
3	138.359	216.218
4	157.995	220.016
5	177.360	225.015
6	196.380	231.199
7	214.983	238.543
8	233.098	247.019
9	238.563	250.000

Circle Center At X = 86.615 ; Y = 536.479 ; and Radius = 324.414
 Factor of Safety
 *** 1.674 ***

Failure Surface Specified By 9 Coordinate Points

Point No.	X-Surf (ft)	Y-Surf (ft)
1	98.571	212.286
2	118.507	213.895
3	138.310	216.692

4 157.911 220.667
 5 177.240 225.805
 6 196.227 232.088
 7 214.805 239.495
 8 232.908 247.997
 9 236.584 250.000

Circle Center At X = 81.618 ; Y = 546.584 ; and Radius = 334.728
 Factor of Safety
 *** 1.675 ***

Failure Surface Specified By 8 Coordinate Points

Point No.	X-Surf (ft)	Y-Surf (ft)
1	104.286	213.810
2	124.226	215.348
3	143.979	218.483
4	163.416	223.194
5	182.412	229.452
6	200.844	237.215
7	218.593	246.433
8	224.290	250.000

Circle Center At X = 95.548 ; Y = 459.840 ; and Radius = 246.186
 Factor of Safety
 *** 1.675 ***

Failure Surface Specified By 8 Coordinate Points

Point No.	X-Surf (ft)	Y-Surf (ft)
1	104.286	213.810
2	124.246	215.074
3	144.060	217.792
4	163.624	221.948
5	182.832	227.520
6	201.582	234.478
7	219.775	242.786
8	232.938	250.000

Circle Center At X = 97.228 ; Y = 485.665 ; and Radius = 271.947
 Factor of Safety
 *** 1.677 ***

Failure Surface Specified By 9 Coordinate Points

Point No.	X-Surf (ft)	Y-Surf (ft)
1	92.857	210.762
2	112.808	212.159
3	132.623	214.878
4	152.212	218.908
5	171.491	224.231
6	190.373	230.823
7	208.776	238.655
8	226.618	247.692
9	230.509	250.000

Circle Center At X = 81.831 ; Y = 511.401 ; and Radius = 300.841
 Factor of Safety
 *** 1.680 ***

**** END OF GSTABL7 OUTPUT ****

F-F' / Design / Search Along Clay /

z:\2010\10132-01 south shores church - dana point\engineering\2012_10\proposed design\fff_1.pl2 Run By: Username 10/23/2012 02:08PM

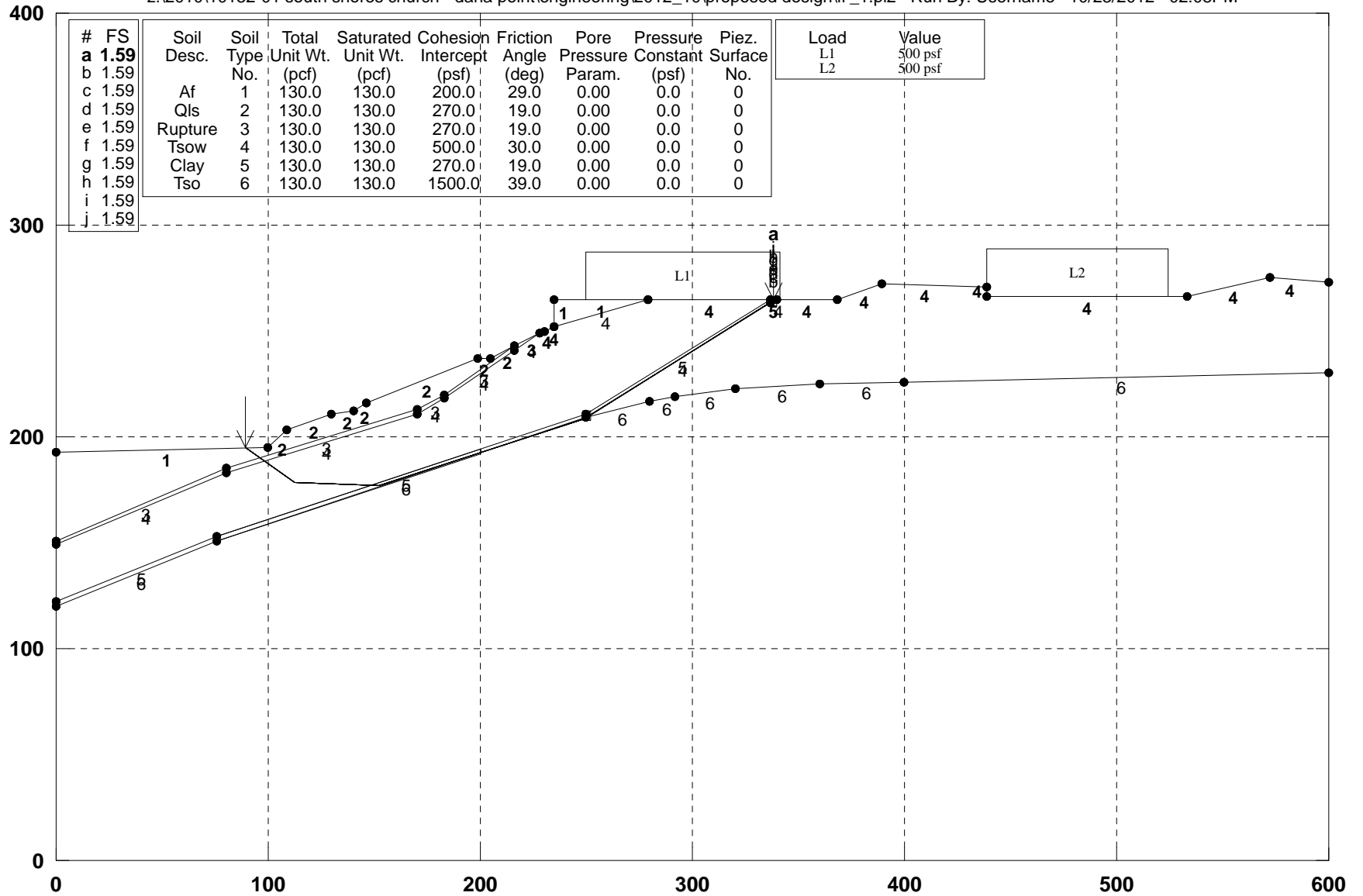

GSTABL7 v.2 FSmin=1.59

Safety Factors Are Calculated By The Simplified Janbu Method for the case of c & phi both > 0

*** GSTABL7 ***

** GSTABL7 by Dr. Garry H. Gregory, Ph.D., P.E., D.GE **

** Original Version 1.0, January 1996; Current Ver. 2.005.2, Jan. 2011 **
(All Rights Reserved-Unauthorizd Use Prohibited)

SLOPE STABILITY ANALYSIS SYSTEM

Modified Bishop, Simplified Janbu, or GLE Method of Slices.
(Includes Spencer & Morgenstern-Price Type Analysis)
Including Pier/Pile, Reinforcement, Soil Nail, Tieback,
Nonlinear Undrained Shear Strength, Curved Phi Envelope,
Anisotropic Soil, Fiber-Reinforced Soil, Boundary Loads, Water
Surfaces, Pseudo-Static & Newmark Earthquake, and Applied Forces.

Analysis Run Date: 10/23/2012
Time of Run: 02:08PM
Run By: Username
Input Data Filename: Z:\2010\10132-01 South Shores Church - Dana Point\Engineerin
g\2012_10\Proposed Design\ff'_1.
Output Filename: Z:\2010\10132-01 South Shores Church - Dana Point\Engineerin
g\2012_10\Proposed Design\ff'_1.OUT
Unit System: English
Plotted Output Filename: Z:\2010\10132-01 South Shores Church - Dana Point\Engineerin
g\2012_10\Proposed Design\ff'_1.PLT

PROBLEM DESCRIPTION: F-F' / Design / Search Along Clay /

BOUNDARY COORDINATES

22 Top Boundaries
45 Total Boundaries

Boundary No.	X-Left (ft)	Y-Left (ft)	X-Right (ft)	Y-Right (ft)	Soil Type Below Bnd
1	0.00	193.00	100.00	195.00	1
2	100.00	195.00	109.00	203.00	2
3	109.00	203.00	130.00	211.00	2
4	130.00	211.00	140.00	212.00	2
5	140.00	212.00	146.00	216.00	2
6	146.00	216.00	199.00	237.00	2
7	199.00	237.00	205.00	237.00	2
8	205.00	237.00	216.00	243.00	2
9	216.00	243.00	228.00	249.00	3
10	228.00	249.00	230.00	250.00	4
11	230.00	250.00	235.00	252.00	4
12	235.00	252.00	235.10	265.00	1
13	235.10	265.00	279.00	265.00	1
14	279.00	265.00	337.00	265.00	4
15	337.00	265.00	340.00	265.00	5
16	340.00	265.00	368.00	265.00	4
17	368.00	265.00	389.00	272.00	4
18	389.00	272.00	439.00	271.00	4
19	439.00	271.00	439.10	266.00	4
20	439.10	266.00	533.00	266.00	4
21	533.00	266.00	572.00	275.00	4
22	572.00	275.00	600.00	273.00	4
23	235.00	252.00	279.00	265.00	4
24	0.00	151.00	80.00	185.00	3
25	80.00	185.00	170.00	213.00	3
26	170.00	213.00	183.00	220.00	3
27	183.00	220.00	216.00	243.00	3
28	0.00	149.00	80.00	183.00	4
29	80.00	183.00	170.00	211.00	4
30	170.00	211.00	183.00	218.00	4
31	183.00	218.00	216.00	241.00	4
32	216.00	241.00	228.00	249.00	4
33	0.00	122.00	76.00	153.00	5
34	76.00	153.00	250.00	211.00	5
35	250.00	211.00	337.00	265.00	5
36	0.00	120.00	76.00	151.00	6
37	76.00	151.00	250.00	209.00	6
38	250.00	209.00	337.00	263.00	4
39	337.00	263.00	340.00	265.00	4
40	250.00	209.00	280.00	217.00	6
41	280.00	217.00	292.00	219.00	6

42	292.00	219.00	320.00	223.00	6
43	320.00	223.00	360.00	225.00	6
44	360.00	225.00	400.00	226.00	6
45	400.00	226.00	600.00	230.00	6

Default Y-Origin = 0.00(ft)
Default X-Plus Value = 0.00(ft)
Default Y-Plus Value = 0.00(ft)

ISOTROPIC SOIL PARAMETERS

6 Type(s) of Soil						
Soil No.	Total (pcf)	Saturated (pcf)	Cohesion (psf)	Friction (deg)	Pore Pressure Param. (psf)	Piez. Constant Surface
1	130.0	130.0	200.0	29.0	0.00	0.0
2	130.0	130.0	270.0	19.0	0.00	0.0
3	130.0	130.0	270.0	19.0	0.00	0.0
4	130.0	130.0	500.0	30.0	0.00	0.0
5	130.0	130.0	270.0	19.0	0.00	0.0
6	130.0	130.0	1500.0	39.0	0.00	0.0

BOUNDARY LOAD(S)

2 Load(s) Specified				
Load No.	X-Left (ft)	X-Right (ft)	Intensity (psf)	Deflection (deg)
1	250.00	341.00	500.0	0.0
2	439.10	524.00	500.0	0.0

NOTE - Intensity Is Specified As A Uniformly Distributed Force Acting On A Horizontally Projected Surface.
Janbus Empirical Coef is being used for the case of c & phi both > 0
A Critical Failure Surface Searching Method, Using A Random Technique For Generating Sliding Block Surfaces, Has Been Specified.

8000 Trial Surfaces Have Been Generated.
3 Boxes Specified For Generation Of Central Block Base
Length Of Line Segments For Active And Passive Portions Of Sliding Block Is 40.0

Box No.	X-Left (ft)	Y-Left (ft)	X-Right (ft)	Y-Right (ft)	Height (ft)
1	76.00	152.00	200.00	193.33	2.00
2	248.00	210.00	252.00	210.00	5.00
3	336.00	263.00	340.00	263.00	2.00

Following Are Displayed The Ten Most Critical Of The Trial

Failure Surfaces Evaluated. They Are Ordered - Most Critical First.
* * Safety Factors Are Calculated By The Simplified Janbu Method * *
Total Number of Trial Surfaces Attempted = 8000
Number of Trial Failure Surfaces is Greater Than 5000.
Statistical Data on FS Values are Not Generated.
To Generate Stastical Data, Reduce Number of Trial Failure Surfaces to 5000 or less.

Failure Surface Specified By 6 Coordinate Points

Point No.	X-Surf (ft)	Y-Surf (ft)
1	89.582	194.792
2	112.193	178.239
3	152.160	176.631
4	249.369	208.797
5	337.390	263.752
6	338.457	265.000

Factor of Safety

*** 1.585 ***

Individual data on the 25 slices									
Slice No.	Width (ft)	Weight (lbs)	Water Force (lbs)		Tie Force (lbs)		Earthquake Force (lbs)		Surcharge Load (lbs)
			Top	Bot	Norm	Tan	Hor	Ver	
1	6.5	2083.7	0.0	0.0	0.0	0.0	0.0	0.0	0.0
2	1.9	1403.5	0.0	0.0	0.0	0.0	0.0	0.0	0.0
3	2.0	1818.5	0.0	0.0	0.0	0.0	0.0	0.0	0.0
4	9.0	17701.1	0.0	0.0	0.0	0.0	0.0	0.0	0.0
5	3.2	10044.4	0.0	0.0	0.0	0.0	0.0	0.0	0.0
6	17.8	68816.1	0.0	0.0	0.0	0.0	0.0	0.0	0.0

7	10.0	44431.8	0.0	0.0	0.	0.	0.0	0.0	0.0
8	6.0	28860.1	0.0	0.0	0.	0.	0.0	0.0	0.0
9	1.5	7490.5	0.0	0.0	0.	0.	0.0	0.0	0.0
10	4.7	24916.2	0.0	0.0	0.	0.	0.0	0.0	0.0
11	17.8	98314.3	0.0	0.0	0.	0.	0.0	0.0	0.0
12	13.0	73345.6	0.0	0.0	0.	0.	0.0	0.0	0.0
13	16.0	92241.8	0.0	0.0	0.	0.	0.0	0.0	0.0
14	6.0	34224.0	0.0	0.0	0.	0.	0.0	0.0	0.0
15	11.0	63012.0	0.0	0.0	0.	0.	0.0	0.0	0.0
16	12.0	72164.0	0.0	0.0	0.	0.	0.0	0.0	0.0
17	2.0	12335.1	0.0	0.0	0.	0.	0.0	0.0	0.0
18	5.0	31060.0	0.0	0.0	0.	0.	0.0	0.0	0.0
19	0.1	707.8	0.0	0.0	0.	0.	0.0	0.0	0.0
20	14.3	108632.7	0.0	0.0	0.	0.	0.0	0.0	0.0
21	0.6	4594.9	0.0	0.0	0.	0.	0.0	0.0	0.0
22	29.0	176269.4	0.0	0.0	0.	0.	0.0	14500.0	0.0
23	58.0	147762.6	0.0	0.0	0.	0.	0.0	29000.0	0.0
24	0.4	69.5	0.0	0.0	0.	0.	0.0	195.2	0.0
25	1.1	86.5	0.0	0.0	0.	0.	0.0	533.3	0.0

Failure Surface Specified By 6 Coordinate Points

Point No.	X-Surf (ft)	Y-Surf (ft)
1	89.582	194.792
2	112.193	178.239
3	152.160	176.631
4	249.369	208.797
5	337.390	263.752
6	338.457	265.000

Factor of Safety
*** 1.585 ***

Failure Surface Specified By 6 Coordinate Points

Point No.	X-Surf (ft)	Y-Surf (ft)
1	89.582	194.792
2	112.193	178.239
3	152.160	176.631
4	249.369	208.797
5	337.390	263.752
6	338.457	265.000

Factor of Safety
*** 1.585 ***

Failure Surface Specified By 6 Coordinate Points

Point No.	X-Surf (ft)	Y-Surf (ft)
1	89.582	194.792
2	112.193	178.239
3	152.160	176.631
4	249.369	208.797
5	337.390	263.752
6	338.457	265.000

Factor of Safety
*** 1.585 ***

Failure Surface Specified By 6 Coordinate Points

Point No.	X-Surf (ft)	Y-Surf (ft)
1	89.582	194.792
2	112.193	178.239
3	152.160	176.631
4	249.369	208.797
5	337.390	263.752
6	338.457	265.000

Factor of Safety
*** 1.585 ***

Failure Surface Specified By 6 Coordinate Points

Point No.	X-Surf (ft)	Y-Surf (ft)
1	89.582	194.792
2	112.193	178.239
3	152.160	176.631
4	249.369	208.797

5	337.390	263.752
6	338.457	265.000

Factor of Safety
*** 1.585 ***

Failure Surface Specified By 6 Coordinate Points

Point No.	X-Surf (ft)	Y-Surf (ft)
1	89.582	194.792
2	112.193	178.239
3	152.160	176.631
4	249.369	208.797
5	337.390	263.752
6	338.457	265.000

Factor of Safety
*** 1.585 ***

Failure Surface Specified By 6 Coordinate Points

Point No.	X-Surf (ft)	Y-Surf (ft)
1	89.582	194.792
2	112.193	178.239
3	152.160	176.631
4	249.369	208.797
5	337.390	263.752
6	338.457	265.000

Factor of Safety
*** 1.585 ***

Failure Surface Specified By 6 Coordinate Points

Point No.	X-Surf (ft)	Y-Surf (ft)
1	89.582	194.792
2	112.193	178.239
3	152.160	176.631
4	249.369	208.797
5	337.390	263.752
6	338.457	265.000

Factor of Safety
*** 1.585 ***

Failure Surface Specified By 6 Coordinate Points

Point No.	X-Surf (ft)	Y-Surf (ft)
1	89.582	194.792
2	112.193	178.239
3	152.160	176.631
4	249.369	208.797
5	337.390	263.752
6	338.457	265.000

Factor of Safety
*** 1.585 ***

**** END OF GSTABL7 OUTPUT ****

F-F' / Design / Search Along Clay / Pseudostatic

z:\2010\10132-01 south shores church - dana point\engineering\2012_10\proposed design\ff_1p.pl2 Run By: Username 10/23/2012 02:08PM

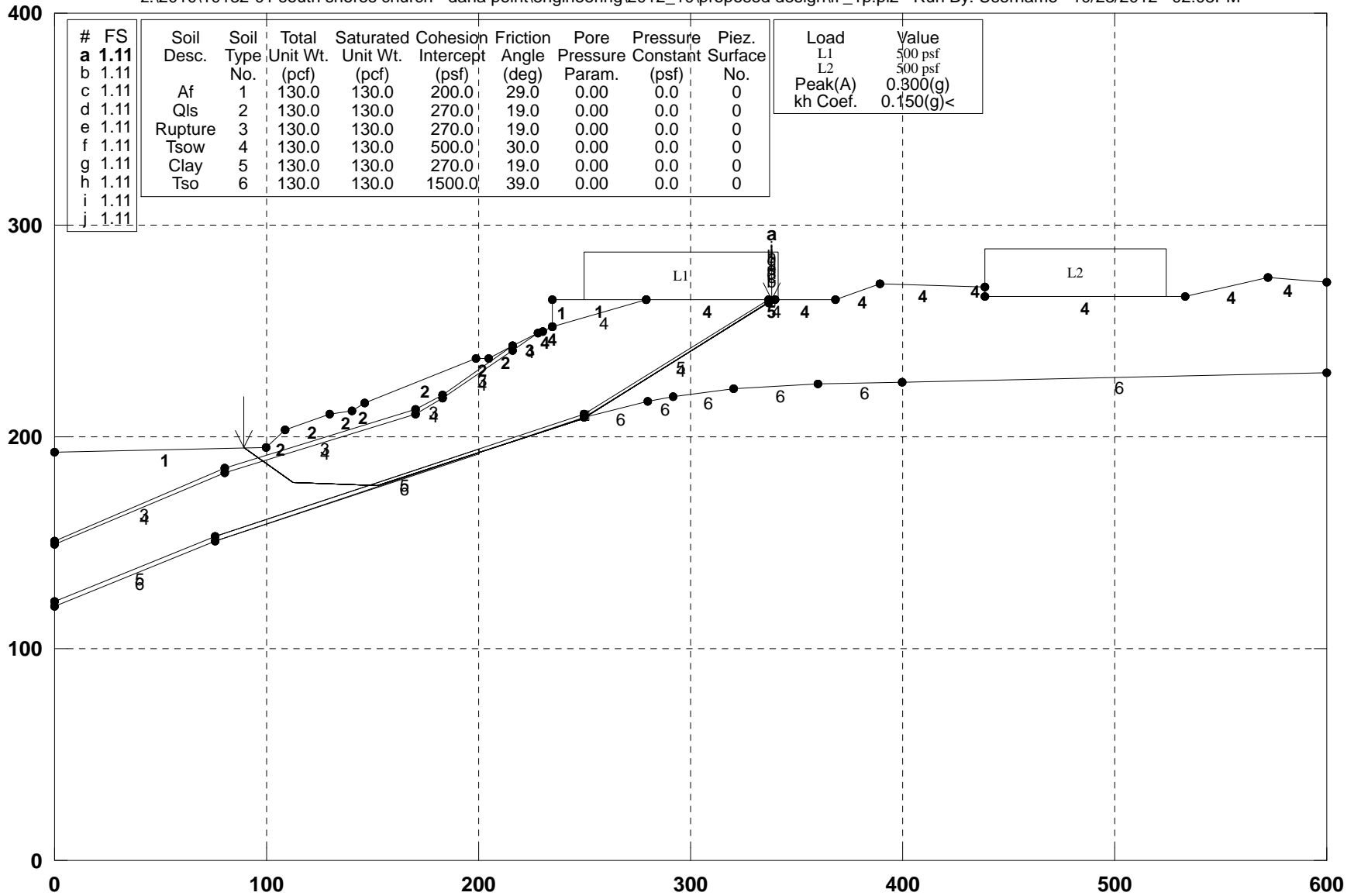

GSTABL7 v.2 FSmin=1.11

Safety Factors Are Calculated By The Simplified Janbu Method for the case of c & phi both > 0

*** GSTABL7 ***

** GSTABL7 by Dr. Garry H. Gregory, Ph.D., P.E., D.GE **

** Original Version 1.0, January 1996; Current Ver. 2.005.2, Jan. 2011 **
 (All Rights Reserved-Unauthorized Use Prohibited)

SLOPE STABILITY ANALYSIS SYSTEM

Modified Bishop, Simplified Janbu, or GLE Method of Slices.
 (Includes Spencer & Morgenstern-Price Type Analysis)
 Including Pier/Pile, Reinforcement, Soil Nail, Tieback,
 Nonlinear Undrained Shear Strength, Curved Phi Envelope,
 Anisotropic Soil, Fiber-Reinforced Soil, Boundary Loads, Water
 Surfaces, Pseudo-Static & Newmark Earthquake, and Applied Forces.

Analysis Run Date: 10/23/2012
 Time of Run: 02:08PM
 Run By: Username
 Input Data Filename: Z:\2010\10132-01 South Shores Church - Dana Point\Engineerin
 g\2012_10\Proposed Design\ff'_lp.
 Output Filename: Z:\2010\10132-01 South Shores Church - Dana Point\Engineerin
 g\2012_10\Proposed Design\ff'_lp.OUT
 Unit System: English
 Plotted Output Filename: Z:\2010\10132-01 South Shores Church - Dana Point\Engineerin
 g\2012_10\Proposed Design\ff'_lp.PLT
 PROBLEM DESCRIPTION: F-F' / Design / Search Along Clay /
 Pseudostatic

BOUNDARY COORDINATES

22 Top Boundaries
 45 Total Boundaries

Boundary No.	X-Left (ft)	Y-Left (ft)	X-Right (ft)	Y-Right (ft)	Soil Type Below Bnd
1	0.00	193.00	100.00	195.00	1
2	100.00	195.00	109.00	203.00	2
3	109.00	203.00	130.00	211.00	2
4	130.00	211.00	140.00	212.00	2
5	140.00	212.00	146.00	216.00	2
6	146.00	216.00	199.00	237.00	2
7	199.00	237.00	205.00	237.00	2
8	205.00	237.00	216.00	243.00	2
9	216.00	243.00	228.00	249.00	3
10	228.00	249.00	230.00	250.00	4
11	230.00	250.00	235.00	252.00	4
12	235.00	252.00	235.10	265.00	1
13	235.10	265.00	279.00	265.00	1
14	279.00	265.00	337.00	265.00	4
15	337.00	265.00	340.00	265.00	5
16	340.00	265.00	368.00	265.00	4
17	368.00	265.00	389.00	272.00	4
18	389.00	272.00	439.00	271.00	4
19	439.00	271.00	439.10	266.00	4
20	439.10	266.00	533.00	266.00	4
21	533.00	266.00	572.00	275.00	4
22	572.00	275.00	600.00	273.00	4
23	235.00	252.00	279.00	265.00	4
24	0.00	151.00	80.00	185.00	3
25	80.00	185.00	170.00	213.00	3
26	170.00	213.00	183.00	220.00	3
27	183.00	220.00	216.00	243.00	3
28	0.00	149.00	80.00	183.00	4
29	80.00	183.00	170.00	211.00	4
30	170.00	211.00	183.00	218.00	4
31	183.00	218.00	216.00	241.00	4
32	216.00	241.00	228.00	249.00	4
33	0.00	122.00	76.00	153.00	5
34	76.00	153.00	250.00	211.00	5
35	250.00	211.00	337.00	265.00	5
36	0.00	120.00	76.00	151.00	6
37	76.00	151.00	250.00	209.00	6
38	250.00	209.00	337.00	263.00	4
39	337.00	263.00	340.00	265.00	4
40	250.00	209.00	280.00	217.00	6

41	280.00	217.00	292.00	219.00	6
42	292.00	219.00	320.00	223.00	6
43	320.00	223.00	360.00	225.00	6
44	360.00	225.00	400.00	226.00	6
45	400.00	226.00	600.00	230.00	6

Default Y-Origin = 0.00(ft)
 Default X-Plus Value = 0.00(ft)
 Default Y-Plus Value = 0.00(ft)

ISOTROPIC SOIL PARAMETERS

Soil Type No.	Total Unit Wt. (pcf)	Saturated Unit Wt. (pcf)	Cohesion (psf)	Friction Angle (deg)	Pore Pressure Param. (psf)	Pressure Constant (psf)	Piez. Surface No.
1	130.0	130.0	200.0	29.0	0.00	0.0	0
2	130.0	130.0	270.0	19.0	0.00	0.0	0
3	130.0	130.0	270.0	19.0	0.00	0.0	0
4	130.0	130.0	500.0	30.0	0.00	0.0	0
5	130.0	130.0	270.0	19.0	0.00	0.0	0
6	130.0	130.0	1500.0	39.0	0.00	0.0	0

BOUNDARY LOAD(S)

Load No.	X-Left (ft)	X-Right (ft)	Intensity (psf)	Deflection (deg)
1	250.00	341.00	500.0	0.0
2	439.10	524.00	500.0	0.0

NOTE - Intensity Is Specified As A Uniformly Distributed

Force Acting On A Horizontally Projected Surface.

Specified Peak Ground Acceleration Coefficient (A) = 0.300(g)

Specified Horizontal Earthquake Coefficient (kh) = 0.150(g)

Specified Vertical Earthquake Coefficient (kv) = 0.000(g)

Specified Seismic Pore-Pressure Factor = 0.000

Janbus Empirical Coef is being used for the case of c & phi both > 0

A Critical Failure Surface Searching Method, Using A Random

Technique For Generating Sliding Block Surfaces, Has Been

Specified.

8000 Trial Surfaces Have Been Generated.

3 Boxes Specified For Generation Of Central Block Base

Length Of Line Segments For Active And Passive Portions Of

Sliding Block Is 40.0

Box No.	X-Left (ft)	Y-Left (ft)	X-Right (ft)	Y-Right (ft)	Height (ft)
1	76.00	152.00	200.00	193.33	2.00
2	248.00	210.00	252.00	210.00	5.00
3	336.00	263.00	340.00	263.00	2.00

Following Are Displayed The Ten Most Critical Of The Trial

Failure Surfaces Evaluated. They Are

Ordered - Most Critical First.

* * Safety Factors Are Calculated By The Simplified Janbu Method * *

Total Number of Trial Surfaces Attempted = 8000

Number of Trial Failure Surfaces is Greater Than 5000.

Statistical Data on FS Values are Not Generated.

To Generate Stastical Data, Reduce Number of Trial

Failure Surfaces to 5000 or less.

Failure Surface Specified By 6 Coordinate Points

Point No.	X-Surf (ft)	Y-Surf (ft)
1	89.582	194.792
2	112.193	178.239
3	152.160	176.631
4	249.369	208.797
5	337.390	263.752
6	338.457	265.000

Factor of Safety

*** 1.105 ***

Individual data on the 25 slices

Slice No.	Width (ft)	Weight (lbs)	Water Force (lbs)		Tie Force (lbs)		Earthquake Force (lbs)		Surcharge Load (lbs)
			Top	Bot	Norm	Tan	Hor	Ver	
1	6.5	2083.7	0.0	0.0	0.0	0.0	0.0	312.6	0.0

2	1.9	1403.5	0.0	0.0	0.	0.	210.5	0.0	0.0
3	2.0	1818.5	0.0	0.0	0.	0.	272.8	0.0	0.0
4	9.0	17701.1	0.0	0.0	0.	0.	2655.2	0.0	0.0
5	3.2	10044.4	0.0	0.0	0.	0.	1506.7	0.0	0.0
6	17.8	68816.1	0.0	0.0	0.	0.	10322.4	0.0	0.0
7	10.0	44431.8	0.0	0.0	0.	0.	6664.8	0.0	0.0
8	6.0	28860.1	0.0	0.0	0.	0.	4329.0	0.0	0.0
9	1.5	7490.5	0.0	0.0	0.	0.	1123.6	0.0	0.0
10	4.7	24916.2	0.0	0.0	0.	0.	3737.4	0.0	0.0
11	17.8	98314.3	0.0	0.0	0.	0.	14747.1	0.0	0.0
12	13.0	73345.6	0.0	0.0	0.	0.	11001.8	0.0	0.0
13	16.0	92241.8	0.0	0.0	0.	0.	13836.3	0.0	0.0
14	6.0	34224.0	0.0	0.0	0.	0.	5133.6	0.0	0.0
15	11.0	63012.0	0.0	0.0	0.	0.	9451.8	0.0	0.0
16	12.0	72164.0	0.0	0.0	0.	0.	10824.6	0.0	0.0
17	2.0	12335.1	0.0	0.0	0.	0.	1850.3	0.0	0.0
18	5.0	31060.0	0.0	0.0	0.	0.	4659.0	0.0	0.0
19	0.1	707.8	0.0	0.0	0.	0.	106.2	0.0	0.0
20	14.3	108632.7	0.0	0.0	0.	0.	16294.9	0.0	0.0
21	0.6	4594.9	0.0	0.0	0.	0.	689.2	0.0	0.0
22	29.0	176269.4	0.0	0.0	0.	0.	26440.4	0.0	14500.0
23	58.0	147762.6	0.0	0.0	0.	0.	22164.4	0.0	29000.0
24	0.4	69.5	0.0	0.0	0.	0.	10.4	0.0	195.2
25	1.1	86.5	0.0	0.0	0.	0.	13.0	0.0	533.3

Failure Surface Specified By 6 Coordinate Points

Point No.	X-Surf (ft)	Y-Surf (ft)
1	89.582	194.792
2	112.193	178.239
3	152.160	176.631
4	249.369	208.797
5	337.390	263.752
6	338.457	265.000

Factor of Safety
*** 1.105 ***

Failure Surface Specified By 6 Coordinate Points

Point No.	X-Surf (ft)	Y-Surf (ft)
1	89.582	194.792
2	112.193	178.239
3	152.160	176.631
4	249.369	208.797
5	337.390	263.752
6	338.457	265.000

Factor of Safety
*** 1.105 ***

Failure Surface Specified By 6 Coordinate Points

Point No.	X-Surf (ft)	Y-Surf (ft)
1	89.582	194.792
2	112.193	178.239
3	152.160	176.631
4	249.369	208.797
5	337.390	263.752
6	338.457	265.000

Factor of Safety
*** 1.105 ***

Failure Surface Specified By 6 Coordinate Points

Point No.	X-Surf (ft)	Y-Surf (ft)
1	89.582	194.792
2	112.193	178.239
3	152.160	176.631
4	249.369	208.797
5	337.390	263.752
6	338.457	265.000

Factor of Safety
*** 1.105 ***

Failure Surface Specified By 6 Coordinate Points

Point	X-Surf	Y-Surf
-------	--------	--------

No.	(ft)	(ft)
1	89.582	194.792
2	112.193	178.239
3	152.160	176.631
4	249.369	208.797
5	337.390	263.752
6	338.457	265.000

Factor of Safety
*** 1.105 ***

Failure Surface Specified By 6 Coordinate Points

Point No.	X-Surf (ft)	Y-Surf (ft)
1	89.582	194.792
2	112.193	178.239
3	152.160	176.631
4	249.369	208.797
5	337.390	263.752
6	338.457	265.000

Factor of Safety
*** 1.105 ***

Failure Surface Specified By 6 Coordinate Points

Point No.	X-Surf (ft)	Y-Surf (ft)
1	89.582	194.792
2	112.193	178.239
3	152.160	176.631
4	249.369	208.797
5	337.390	263.752
6	338.457	265.000

Factor of Safety
*** 1.105 ***

Failure Surface Specified By 6 Coordinate Points

Point No.	X-Surf (ft)	Y-Surf (ft)
1	89.582	194.792
2	112.193	178.239
3	152.160	176.631
4	249.369	208.797
5	337.390	263.752
6	338.457	265.000

Factor of Safety
*** 1.105 ***

Failure Surface Specified By 6 Coordinate Points

Point No.	X-Surf (ft)	Y-Surf (ft)
1	89.582	194.792
2	112.193	178.239
3	152.160	176.631
4	249.369	208.797
5	337.390	263.752
6	338.457	265.000

Factor of Safety
*** 1.105 ***

**** END OF GSTABL7 OUTPUT ****

F-F' / Design / Circular Search

z:\2010\10132-01 south shores church - dana point\engineering\2012_10\proposed design\ff_1c.pl2 Run By: Username 10/23/2012 02:12PM

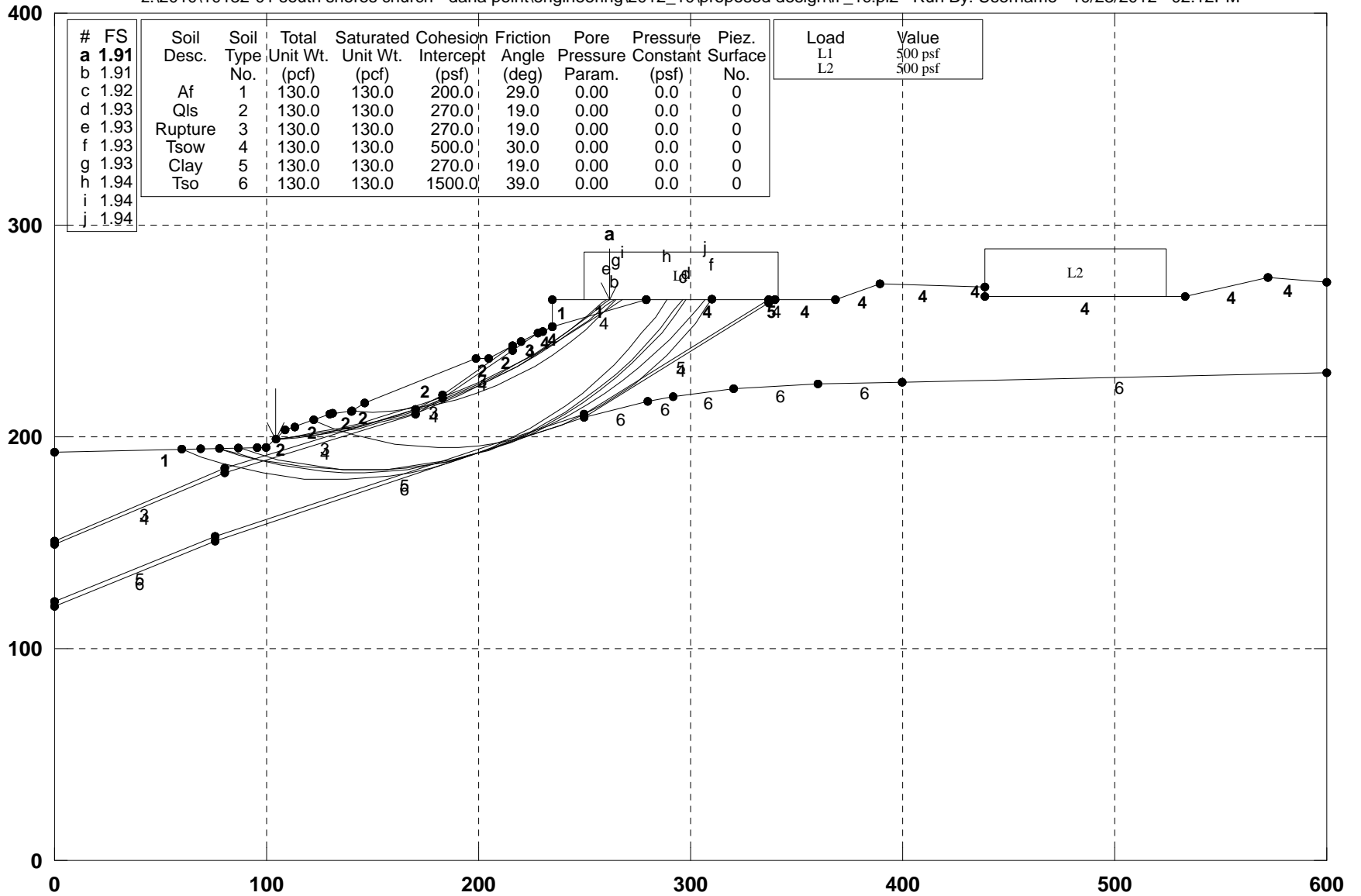

GSTABL7 v.2 FSmin=1.91

Safety Factors Are Calculated By The Modified Bishop Method

*** GSTABL7 ***

** GSTABL7 by Dr. Garry H. Gregory, Ph.D.,P.E.,D.GE **

** Original Version 1.0, January 1996; Current Ver. 2.005.2, Jan. 2011 **
(All Rights Reserved-Unauthorizd Use Prohibited)

SLOPE STABILITY ANALYSIS SYSTEM

Modified Bishop, Simplified Janbu, or GLE Method of Slices.
(Includes Spencer & Morgenstern-Price Type Analysis)
Including Pier/Pile, Reinforcement, Soil Nail, Tieback,
Nonlinear Undrained Shear Strength, Curved Phi Envelope,
Anisotropic Soil, Fiber-Reinforced Soil, Boundary Loads, Water
Surfaces, Pseudo-Static & Newmark Earthquake, and Applied Forces.

Analysis Run Date: 10/23/2012
Time of Run: 02:12PM
Run By: Username
Input Data Filename: Z:\2010\10132-01 South Shores Church - Dana Point\Engineerin
g\2012_10\Proposed Design\ff'_1c.
Output Filename: Z:\2010\10132-01 South Shores Church - Dana Point\Engineerin
g\2012_10\Proposed Design\ff'_1c.OUT
Unit System: English
Plotted Output Filename: Z:\2010\10132-01 South Shores Church - Dana Point\Engineerin
g\2012_10\Proposed Design\ff'_1c.PLT

PROBLEM DESCRIPTION: F-F' / Design / Circular Search

BOUNDARY COORDINATES

Boundary No.	X-Left (ft)	Y-Left (ft)	X-Right (ft)	Y-Right (ft)	Soil Type Below Bnd
1	0.00	193.00	100.00	195.00	1
2	100.00	195.00	109.00	203.00	2
3	109.00	203.00	130.00	211.00	2
4	130.00	211.00	140.00	212.00	2
5	140.00	212.00	146.00	216.00	2
6	146.00	216.00	199.00	237.00	2
7	199.00	237.00	205.00	237.00	2
8	205.00	237.00	216.00	243.00	2
9	216.00	243.00	228.00	249.00	3
10	228.00	249.00	230.00	250.00	4
11	230.00	250.00	235.00	252.00	4
12	235.00	252.00	235.10	265.00	1
13	235.10	265.00	279.00	265.00	1
14	279.00	265.00	337.00	265.00	4
15	337.00	265.00	340.00	265.00	5
16	340.00	265.00	368.00	265.00	4
17	368.00	265.00	389.00	272.00	4
18	389.00	272.00	439.00	271.00	4
19	439.00	271.00	439.10	266.00	4
20	439.10	266.00	533.00	266.00	4
21	533.00	266.00	572.00	275.00	4
22	572.00	275.00	600.00	273.00	4
23	235.00	252.00	279.00	265.00	4
24	0.00	151.00	80.00	185.00	3
25	80.00	185.00	170.00	213.00	3
26	170.00	213.00	183.00	220.00	3
27	183.00	220.00	216.00	243.00	3
28	0.00	149.00	80.00	183.00	4
29	80.00	183.00	170.00	211.00	4
30	170.00	211.00	183.00	218.00	4
31	183.00	218.00	216.00	241.00	4
32	216.00	241.00	228.00	249.00	4
33	0.00	122.00	76.00	153.00	5
34	76.00	153.00	250.00	211.00	5
35	250.00	211.00	337.00	265.00	5
36	0.00	120.00	76.00	151.00	6
37	76.00	151.00	250.00	209.00	6
38	250.00	209.00	337.00	263.00	4
39	337.00	263.00	340.00	265.00	4
40	250.00	209.00	280.00	217.00	6
41	280.00	217.00	292.00	219.00	6

42	292.00	219.00	320.00	223.00	6
43	320.00	223.00	360.00	225.00	6
44	360.00	225.00	400.00	226.00	6
45	400.00	226.00	600.00	230.00	6

Default Y-Origin = 0.00(ft)
Default X-Plus Value = 0.00(ft)
Default Y-Plus Value = 0.00(ft)

ISOTROPIC SOIL PARAMETERS

6 Type(s) of Soil							
Soil No.	Total (pcf)	Saturated (pcf)	Cohesion (psf)	Friction Angle (deg)	Pore Pressure Param. (psf)	Pressure Constant (psf)	Piez. Surface No.
1	130.0	130.0	200.0	29.0	0.00	0.0	0
2	130.0	130.0	270.0	19.0	0.00	0.0	0
3	130.0	130.0	270.0	19.0	0.00	0.0	0
4	130.0	130.0	500.0	30.0	0.00	0.0	0
5	130.0	130.0	270.0	19.0	0.00	0.0	0
6	130.0	130.0	1500.0	39.0	0.00	0.0	0

BOUNDARY LOAD(S)

2 Load(s) Specified				
Load No.	X-Left (ft)	X-Right (ft)	Intensity (psf)	Deflection (deg)
1	250.00	341.00	500.0	0.0
2	439.10	524.00	500.0	0.0

NOTE - Intensity Is Specified As A Uniformly Distributed Force Acting On A Horizontally Projected Surface.
A Critical Failure Surface Searching Method, Using A Random Technique For Generating Circular Surfaces, Has Been Specified.
5000 Trial Surfaces Have Been Generated.
5000 Surface(s) Initiate(s) From Each Of 10 Points Equally Spaced Along The Ground Surface Between X = 60.00(ft) and X = 140.00(ft)
Each Surface Terminates Between X = 220.00(ft) and X = 310.00(ft)

Unless Further Limitations Were Imposed, The Minimum Elevation At Which A Surface Extends Is Y = 0.00(ft)
10.00(ft) Line Segments Define Each Trial Failure Surface.
Following Are Displayed The Ten Most Critical Of The Trial Failure Surfaces Evaluated. They Are Ordered - Most Critical First.
* * Safety Factors Are Calculated By The Modified Bishop Method * *
Total Number of Trial Surfaces Attempted = 5000
Number of Trial Surfaces With Valid FS = 5000
Statistical Data On All Valid FS Values:
FS Max = 4.751 FS Min = 1.909 FS Ave = 3.246
Standard Deviation = 0.865 Coefficient of Variation = 26.65 %

Failure Surface Specified By 19 Coordinate Points

Point No.	X-Surf (ft)	Y-Surf (ft)
1	104.444	198.951
2	114.387	200.025
3	124.284	201.452
4	134.125	203.230
5	143.896	205.356
6	153.586	207.829
7	163.181	210.644
8	172.671	213.798
9	182.042	217.287
10	191.284	221.107
11	200.384	225.254
12	209.331	229.720
13	218.113	234.502
14	226.720	239.593
15	235.141	244.987
16	243.365	250.677
17	251.381	256.655
18	259.180	262.914
19	261.598	265.000

Circle Center At X = 79.186 ; Y = 479.198 ; and Radius = 281.383
Factor of Safety

*** 1.909 ***
 Individual data on the 35 slices

Slice No.	Width (ft)	Weight (lbs)	Water Force		Tie Force		Earthquake Force		Surcharge (lbs)
			Top (lbs)	Bot (lbs)	Norm (lbs)	Tan (lbs)	Hor (lbs)	Ver (lbs)	
1	4.6	1053.3	0.0	0.0	0.0	0.0	0.0	0.0	0.0
2	5.4	3005.5	0.0	0.0	0.0	0.0	0.0	0.0	0.0
3	9.9	7975.8	0.0	0.0	0.0	0.0	0.0	0.0	0.0
4	5.7	5901.9	0.0	0.0	0.0	0.0	0.0	0.0	0.0
5	4.1	4476.9	0.0	0.0	0.0	0.0	0.0	0.0	0.0
6	5.9	5985.6	0.0	0.0	0.0	0.0	0.0	0.0	0.0
7	3.9	4237.5	0.0	0.0	0.0	0.0	0.0	0.0	0.0
8	2.1	2645.8	0.0	0.0	0.0	0.0	0.0	0.0	0.0
9	6.4	8827.6	0.0	0.0	0.0	0.0	0.0	0.0	0.0
10	1.2	1666.9	0.0	0.0	0.0	0.0	0.0	0.0	0.0
11	9.6	14558.1	0.0	0.0	0.0	0.0	0.0	0.0	0.0
12	6.8	10975.4	0.0	0.0	0.0	0.0	0.0	0.0	0.0
13	2.7	4404.3	0.0	0.0	0.0	0.0	0.0	0.0	0.0
14	8.2	13691.9	0.0	0.0	0.0	0.0	0.0	0.0	0.0
15	1.2	2001.8	0.0	0.0	0.0	0.0	0.0	0.0	0.0
16	1.0	1616.6	0.0	0.0	0.0	0.0	0.0	0.0	0.0
17	8.3	13898.8	0.0	0.0	0.0	0.0	0.0	0.0	0.0
18	7.7	12645.1	0.0	0.0	0.0	0.0	0.0	0.0	0.0
19	1.4	2169.9	0.0	0.0	0.0	0.0	0.0	0.0	0.0
20	4.6	6357.5	0.0	0.0	0.0	0.0	0.0	0.0	0.0
21	4.3	5372.0	0.0	0.0	0.0	0.0	0.0	0.0	0.0
22	6.7	8362.2	0.0	0.0	0.0	0.0	0.0	0.0	0.0
23	2.1	2637.7	0.0	0.0	0.0	0.0	0.0	0.0	0.0
24	8.6	10249.8	0.0	0.0	0.0	0.0	0.0	0.0	0.0
25	1.3	1443.4	0.0	0.0	0.0	0.0	0.0	0.0	0.0
26	2.0	2196.0	0.0	0.0	0.0	0.0	0.0	0.0	0.0
27	5.0	5007.9	0.0	0.0	0.0	0.0	0.0	0.0	0.0
28	0.1	176.4	0.0	0.0	0.0	0.0	0.0	0.0	0.0
29	0.0	106.9	0.0	0.0	0.0	0.0	0.0	0.0	0.0
30	8.2	18354.2	0.0	0.0	0.0	0.0	0.0	0.0	0.0
31	6.6	10221.0	0.0	0.0	0.0	0.0	0.0	0.0	0.0
32	1.4	1590.9	0.0	0.0	0.0	0.0	0.0	0.0	690.6
33	0.4	389.3	0.0	0.0	0.0	0.0	0.0	0.0	182.6
34	7.4	4898.7	0.0	0.0	0.0	0.0	0.0	0.0	3716.8
35	2.4	327.9	0.0	0.0	0.0	0.0	0.0	0.0	1209.0

Failure Surface Specified By 19 Coordinate Points

Point No.	X-Surf (ft)	Y-Surf (ft)
1	104.444	198.951
2	114.394	199.957
3	124.301	201.313
4	134.155	203.018
5	143.942	205.070
6	153.651	207.465
7	163.269	210.202
8	172.785	213.276
9	182.186	216.684
10	191.462	220.422
11	200.599	224.484
12	209.588	228.866
13	218.416	233.563
14	227.074	238.568
15	235.549	243.875
16	243.832	249.478
17	251.912	255.370
18	259.779	261.543
19	263.878	265.000

Circle Center At X = 80.910 ; Y = 481.396 ; and Radius = 283.424
 Factor of Safety
 *** 1.912 ***

Failure Surface Specified By 26 Coordinate Points

Point No.	X-Surf (ft)	Y-Surf (ft)
1	77.778	194.556

2	87.255	191.365
3	96.890	188.689
4	106.656	186.534
5	116.522	184.907
6	126.462	183.812
7	136.446	183.253
8	146.446	183.231
9	156.433	183.746
10	166.378	184.796
11	176.252	186.380
12	186.026	188.492
13	195.673	191.125
14	205.165	194.273
15	214.473	197.927
16	223.572	202.075
17	232.435	206.706
18	241.037	211.807
19	249.352	217.362
20	257.357	223.356
21	265.028	229.771
22	272.343	236.589
23	279.282	243.790
24	285.823	251.353
25	291.949	259.257
26	295.925	265.000

Circle Center At X = 141.854 ; Y = 369.122 ; and Radius = 185.955
 Factor of Safety
 *** 1.924 ***

Failure Surface Specified By 25 Coordinate Points

Point No.	X-Surf (ft)	Y-Surf (ft)
1	86.667	194.733
2	96.192	191.689
3	105.870	189.171
4	115.671	187.189
5	125.567	185.747
6	135.527	184.851
7	145.521	184.503
8	155.519	184.705
9	165.490	185.454
10	175.406	186.750
11	185.236	188.588
12	194.950	190.963
13	204.518	193.868
14	213.913	197.294
15	223.106	201.230
16	232.069	205.664
17	240.775	210.584
18	249.198	215.975
19	257.312	221.819
20	265.093	228.101
21	272.518	234.800
22	279.563	241.896
23	286.209	249.368
24	292.434	257.194
25	297.972	265.000

Circle Center At X = 146.858 ; Y = 366.608 ; and Radius = 182.110
 Factor of Safety
 *** 1.926 ***

Failure Surface Specified By 19 Coordinate Points

Point No.	X-Surf (ft)	Y-Surf (ft)
1	104.444	198.951
2	114.417	199.695
3	124.351	200.839
4	134.231	202.381
5	144.042	204.320
6	153.766	206.651
7	163.389	209.371
8	172.895	212.475

9	182.269	215.959
10	191.495	219.817
11	200.558	224.042
12	209.444	228.628
13	218.139	233.568
14	226.629	238.852
15	234.899	244.474
16	242.936	250.424
17	250.728	256.692
18	258.262	263.267
19	260.093	265.000

Circle Center At X = 90.921 ; Y = 447.385 ; and Radius = 248.802

Factor of Safety
*** 1.927 ***

Failure Surface Specified By 23 Coordinate Points

Point No.	X-Surf (ft)	Y-Surf (ft)
1	122.222	208.037
2	131.475	204.245
3	140.962	201.081
4	150.639	198.560
5	160.463	196.692
6	170.390	195.486
7	180.375	194.948
8	190.374	195.079
9	200.342	195.880
10	210.234	197.346
11	220.006	199.471
12	229.613	202.246
13	239.013	205.657
14	248.164	209.691
15	257.023	214.328
16	265.553	219.548
17	273.714	225.327
18	281.469	231.640
19	288.785	238.458
20	295.627	245.750
21	301.966	253.485
22	307.773	261.626
23	309.854	265.000

Circle Center At X = 183.416 ; Y = 344.183 ; and Radius = 149.266

Factor of Safety
*** 1.932 ***

Failure Surface Specified By 15 Coordinate Points

Point No.	X-Surf (ft)	Y-Surf (ft)
1	140.000	212.000
2	149.999	211.830
3	159.987	212.305
4	169.924	213.423
5	179.769	215.180
6	189.480	217.568
7	199.016	220.578
8	208.338	224.196
9	217.408	228.409
10	226.187	233.197
11	234.639	238.542
12	242.728	244.421
13	250.422	250.809
14	257.687	257.680
15	264.489	265.000

Circle Center At X = 147.636 ; Y = 366.768 ; and Radius = 154.956

Factor of Safety
*** 1.934 ***

Failure Surface Specified By 28 Coordinate Points

Point No.	X-Surf (ft)	Y-Surf (ft)
1	60.000	194.200
2	69.327	190.593
3	78.833	187.489

4	88.492	184.899
5	98.275	182.828
6	108.155	181.284
7	118.104	180.271
8	128.092	179.791
9	138.092	179.847
10	148.074	180.436
11	158.011	181.560
12	167.874	183.212
13	177.634	185.390
14	187.263	188.087
15	196.734	191.295
16	206.021	195.006
17	215.095	199.207
18	223.932	203.888
19	232.506	209.035
20	240.792	214.633
21	248.767	220.666
22	256.408	227.117
23	263.693	233.967
24	270.601	241.198
25	277.113	248.787
26	283.209	256.714
27	288.873	264.956
28	288.900	265.000

Circle Center At X = 132.061 ; Y = 366.645 ; and Radius = 186.896

Factor of Safety
*** 1.935 ***

Failure Surface Specified By 19 Coordinate Points

Point No.	X-Surf (ft)	Y-Surf (ft)
1	104.444	198.951
2	114.335	200.425
3	124.180	202.179
4	133.972	204.210
5	143.702	206.516
6	153.363	209.097
7	162.948	211.950
8	172.448	215.073
9	181.855	218.463
10	191.164	222.117
11	200.365	226.033
12	209.452	230.208
13	218.418	234.638
14	227.254	239.319
15	235.955	244.248
16	244.513	249.421
17	252.921	254.834
18	261.173	260.482
19	267.390	265.000

Circle Center At X = 57.225 ; Y = 549.597 ; and Radius = 353.811

Factor of Safety
*** 1.937 ***

Failure Surface Specified By 27 Coordinate Points

Point No.	X-Surf (ft)	Y-Surf (ft)
1	77.778	194.556
2	87.359	191.693
3	97.067	189.293
4	106.879	187.361
5	116.772	185.903
6	126.723	184.921
7	136.711	184.418
8	146.711	184.395
9	156.700	184.851
10	166.656	185.786
11	176.556	187.199
12	186.377	189.084
13	196.096	191.439
14	205.690	194.257

15	215.139	197.533
16	224.419	201.258
17	233.510	205.424
18	242.390	210.021
19	251.040	215.040
20	259.439	220.467
21	267.567	226.292
22	275.407	232.500
23	282.940	239.077
24	290.149	246.008
25	297.016	253.276
26	303.527	260.866
27	306.742	265.000

Circle Center At X = 142.197 ; Y = 392.674 ; and Radius = 208.329
Factor of Safety
*** 1.937 ***
**** END OF GSTABL7 OUTPUT ****

*** GSTABL7 ***

** GSTABL7 by Dr. Garry H. Gregory, Ph.D.,P.E.,D.GE **

** Original Version 1.0, January 1996; Current Ver. 2.005.2, Jan. 2011 **
(All Rights Reserved-Unauthorizd Use Prohibited)

SLOPE STABILITY ANALYSIS SYSTEM

Modified Bishop, Simplified Janbu, or GLE Method of Slices.
(Includes Spencer & Morgenstern-Price Type Analysis)
Including Pier/Pile, Reinforcement, Soil Nail, Tieback,
Nonlinear Undrained Shear Strength, Curved Phi Envelope,
Anisotropic Soil, Fiber-Reinforced Soil, Boundary Loads, Water
Surfaces, Pseudo-Static & Newmark Earthquake, and Applied Forces.

Analysis Run Date: 10/23/2012
Time of Run: 02:13PM
Run By: Username
Input Data Filename: Z:\2010\10132-01 South Shores Church - Dana Point\Engineerin
g\2012_10\Proposed Design\ff'_lcp.
Output Filename: Z:\2010\10132-01 South Shores Church - Dana Point\Engineerin
g\2012_10\Proposed Design\ff'_lcp.OUT
Unit System: English
Plotted Output Filename: Z:\2010\10132-01 South Shores Church - Dana Point\Engineerin
g\2012_10\Proposed Design\ff'_lcp.PLT
PROBLEM DESCRIPTION: F-F' / Design / Circular Search /
Pseudostatic

BOUNDARY COORDINATES

22 Top Boundaries
45 Total Boundaries

Boundary No.	X-Left (ft)	Y-Left (ft)	X-Right (ft)	Y-Right (ft)	Soil Type Below Bnd
1	0.00	193.00	100.00	195.00	1
2	100.00	195.00	109.00	203.00	2
3	109.00	203.00	130.00	211.00	2
4	130.00	211.00	140.00	212.00	2
5	140.00	212.00	146.00	216.00	2
6	146.00	216.00	199.00	237.00	2
7	199.00	237.00	205.00	237.00	2
8	205.00	237.00	216.00	243.00	2
9	216.00	243.00	228.00	249.00	3
10	228.00	249.00	230.00	250.00	4
11	230.00	250.00	235.00	252.00	4
12	235.00	252.00	235.10	265.00	1
13	235.10	265.00	279.00	265.00	1
14	279.00	265.00	337.00	265.00	4
15	337.00	265.00	340.00	265.00	5
16	340.00	265.00	368.00	265.00	4
17	368.00	265.00	389.00	272.00	4
18	389.00	272.00	439.00	271.00	4
19	439.00	271.00	439.10	266.00	4
20	439.10	266.00	533.00	266.00	4
21	533.00	266.00	572.00	275.00	4
22	572.00	275.00	600.00	273.00	4
23	235.00	252.00	279.00	265.00	4
24	0.00	151.00	80.00	185.00	3
25	80.00	185.00	170.00	213.00	3
26	170.00	213.00	183.00	220.00	3
27	183.00	220.00	216.00	243.00	3
28	0.00	149.00	80.00	183.00	4
29	80.00	183.00	170.00	211.00	4
30	170.00	211.00	183.00	218.00	4
31	183.00	218.00	216.00	241.00	4
32	216.00	241.00	228.00	249.00	4
33	0.00	122.00	76.00	153.00	5
34	76.00	153.00	250.00	211.00	5
35	250.00	211.00	337.00	265.00	5
36	0.00	120.00	76.00	151.00	6
37	76.00	151.00	250.00	209.00	6
38	250.00	209.00	337.00	263.00	4
39	337.00	263.00	340.00	265.00	4
40	250.00	209.00	280.00	217.00	6

41	280.00	217.00	292.00	219.00	6
42	292.00	219.00	320.00	223.00	6
43	320.00	223.00	360.00	225.00	6
44	360.00	225.00	400.00	226.00	6
45	400.00	226.00	600.00	230.00	6

Default Y-Origin = 0.00(ft)
Default X-Plus Value = 0.00(ft)
Default Y-Plus Value = 0.00(ft)

ISOTROPIC SOIL PARAMETERS

Soil No.	Total (pcf)	Saturated (pcf)	Cohesion (psf)	Friction Angle (deg)	Pore Pressure Param. (psf)	Pressure Constant (psf)	Piez. Surface
1	130.0	130.0	200.0	29.0	0.00	0.0	0
2	130.0	130.0	270.0	19.0	0.00	0.0	0
3	130.0	130.0	270.0	19.0	0.00	0.0	0
4	130.0	130.0	500.0	30.0	0.00	0.0	0
5	130.0	130.0	270.0	19.0	0.00	0.0	0
6	130.0	130.0	1500.0	39.0	0.00	0.0	0

BOUNDARY LOAD(S)

Load No.	X-Left (ft)	X-Right (ft)	Intensity (psf)	Deflection (deg)
1	250.00	341.00	500.0	0.0
2	439.10	524.00	500.0	0.0

NOTE - Intensity Is Specified As A Uniformly Distributed

Force Acting On A Horizontally Projected Surface.
Specified Peak Ground Acceleration Coefficient (A) = 0.300(g)
Specified Horizontal Earthquake Coefficient (kh) = 0.150(g)
Specified Vertical Earthquake Coefficient (kv) = 0.000(g)
Specified Seismic Pore-Pressure Factor = 0.000
A Critical Failure Surface Searching Method, Using A Random
Technique For Generating Circular Surfaces, Has Been Specified.
5000 Trial Surfaces Have Been Generated.

500 Surface(s) Initiate(s) From Each Of 10 Points Equally Spaced
Along The Ground Surface Between X = 60.00(ft)
and X = 140.00(ft)
Each Surface Terminates Between X = 220.00(ft)
and X = 310.00(ft)

Unless Further Limitations Were Imposed, The Minimum Elevation
At Which A Surface Extends Is Y = 0.00(ft)
10.00(ft) Line Segments Define Each Trial Failure Surface.
Following Are Displayed The Ten Most Critical Of The Trial

Failure Surfaces Evaluated. They Are

Ordered - Most Critical First.

* * Safety Factors Are Calculated By The Modified Bishop Method * *

Total Number of Trial Surfaces Attempted = 5000

Number of Trial Surfaces With Valid FS = 5000

Statistical Data On All Valid FS Values:

FS Max = 3.356 FS Min = 1.354 FS Ave = 2.312

Standard Deviation = 0.621 Coefficient of Variation = 26.84 %

Failure Surface Specified By 27 Coordinate Points

Point No.	X-Surf (ft)	Y-Surf (ft)
1	77.778	194.556
2	87.359	191.693
3	97.067	189.293
4	106.879	187.361
5	116.772	185.903
6	126.723	184.921
7	136.711	184.418
8	146.711	184.395
9	156.700	184.851
10	166.656	185.786
11	176.556	187.199
12	186.377	189.084
13	196.096	191.439
14	205.690	194.257
15	215.139	197.533
16	224.419	201.258

17	233.510	205.424
18	242.390	210.021
19	251.040	215.040
20	259.439	220.467
21	267.567	226.292
22	275.407	232.500
23	282.940	239.077
24	290.149	246.008
25	297.016	253.276
26	303.527	260.866
27	306.742	265.000

Circle Center At X = 142.197 ; Y = 392.674 ; and Radius = 208.329

Factor of Safety

*** 1.354 ***

Individual data on the

Slice No.	Width (ft)	Weight (lbs)	Water		Tie		Earthquake		Surcharge (lbs)
			Top (lbs)	Bot (lbs)	Norm (lbs)	Tan (lbs)	Hor (lbs)	Ver (lbs)	
1	9.6	1902.4	0.0	0.0	0.0	0.0	285.4	0.0	0.0
2	7.9	4211.8	0.0	0.0	0.0	0.0	631.8	0.0	0.0
3	1.8	1280.1	0.0	0.0	0.0	0.0	192.0	0.0	0.0
4	1.9	1473.7	0.0	0.0	0.0	0.0	221.1	0.0	0.0
5	1.0	801.5	0.0	0.0	0.0	0.0	120.2	0.0	0.0
6	6.9	8959.2	0.0	0.0	0.0	0.0	1343.9	0.0	0.0
7	2.1	4096.0	0.0	0.0	0.0	0.0	614.4	0.0	0.0
8	7.8	18190.5	0.0	0.0	0.0	0.0	2728.6	0.0	0.0
9	10.0	29036.5	0.0	0.0	0.0	0.0	4355.5	0.0	0.0
10	3.3	10877.8	0.0	0.0	0.0	0.0	1631.7	0.0	0.0
11	6.7	23335.4	0.0	0.0	0.0	0.0	3500.3	0.0	0.0
12	3.3	11725.5	0.0	0.0	0.0	0.0	1758.8	0.0	0.0
13	6.0	23085.5	0.0	0.0	0.0	0.0	3462.8	0.0	0.0
14	0.7	2933.0	0.0	0.0	0.0	0.0	440.0	0.0	0.0
15	10.0	43683.6	0.0	0.0	0.0	0.0	6552.5	0.0	0.0
16	10.0	47751.1	0.0	0.0	0.0	0.0	7162.7	0.0	0.0
17	3.3	16874.5	0.0	0.0	0.0	0.0	2531.2	0.0	0.0
18	6.6	34158.4	0.0	0.0	0.0	0.0	5123.8	0.0	0.0
19	4.8	25887.8	0.0	0.0	0.0	0.0	3883.2	0.0	0.0
20	1.6	8932.0	0.0	0.0	0.0	0.0	1339.8	0.0	0.0
21	3.4	18687.7	0.0	0.0	0.0	0.0	2803.2	0.0	0.0
22	9.7	55165.2	0.0	0.0	0.0	0.0	8274.8	0.0	0.0
23	2.9	16823.7	0.0	0.0	0.0	0.0	2523.6	0.0	0.0
24	6.0	34185.0	0.0	0.0	0.0	0.0	5127.8	0.0	0.0
25	0.7	3862.1	0.0	0.0	0.0	0.0	579.3	0.0	0.0
26	9.4	54116.5	0.0	0.0	0.0	0.0	8117.5	0.0	0.0
27	0.9	5045.2	0.0	0.0	0.0	0.0	756.8	0.0	0.0
28	8.4	49838.7	0.0	0.0	0.0	0.0	7475.8	0.0	0.0
29	3.6	21426.7	0.0	0.0	0.0	0.0	3214.0	0.0	0.0
30	2.0	11997.2	0.0	0.0	0.0	0.0	1799.6	0.0	0.0
31	3.5	21026.5	0.0	0.0	0.0	0.0	3154.0	0.0	0.0
32	0.4	2576.8	0.0	0.0	0.0	0.0	386.5	0.0	0.0
33	1.1	6313.6	0.0	0.0	0.0	0.0	947.0	0.0	0.0
34	0.1	679.7	0.0	0.0	0.0	0.0	102.0	0.0	0.0
35	7.3	53893.8	0.0	0.0	0.0	0.0	8084.1	0.0	0.0
36	7.6	52204.5	0.0	0.0	0.0	0.0	7830.7	0.0	0.0
37	1.0	6794.6	0.0	0.0	0.0	0.0	1019.2	0.0	519.9
38	8.4	51585.6	0.0	0.0	0.0	0.0	7737.8	0.0	4199.4
39	8.1	43981.2	0.0	0.0	0.0	0.0	6597.2	0.0	4064.3
40	7.8	36286.8	0.0	0.0	0.0	0.0	5443.0	0.0	3919.9
41	3.6	14447.4	0.0	0.0	0.0	0.0	2167.1	0.0	1796.4
42	3.9	14158.9	0.0	0.0	0.0	0.0	2123.8	0.0	1970.0
43	7.2	21045.6	0.0	0.0	0.0	0.0	3156.8	0.0	3604.3
44	6.9	13711.6	0.0	0.0	0.0	0.0	2056.7	0.0	3433.8
45	6.5	6711.1	0.0	0.0	0.0	0.0	1006.7	0.0	3255.5
46	3.2	863.9	0.0	0.0	0.0	0.0	129.6	0.0	1607.5

Failure Surface Specified By 23 Coordinate Points

Point No.	X-Surf (ft)	Y-Surf (ft)
1	122.222	208.037
2	131.475	204.245

3	140.962	201.081
4	150.639	198.560
5	160.463	196.692
6	170.390	195.486
7	180.375	194.948
8	190.374	195.079
9	200.342	195.880
10	210.234	197.346
11	220.006	199.471
12	229.613	202.246
13	239.013	205.657
14	248.164	209.691
15	257.023	214.328
16	265.553	219.548
17	273.714	225.327
18	281.469	231.640
19	288.785	238.458
20	295.627	245.750
21	301.966	253.485
22	307.773	261.626
23	309.854	265.000

Circle Center At X = 183.416 ; Y = 344.183 ; and Radius = 149.266

Factor of Safety

*** 1.356 ***

Failure Surface Specified By 26 Coordinate Points

Point No.	X-Surf (ft)	Y-Surf (ft)
1	77.778	194.556
2	87.255	191.365
3	96.890	188.689
4	106.656	186.534
5	116.522	184.907
6	126.462	183.812
7	136.446	183.253
8	146.446	183.231
9	156.433	183.746
10	166.378	184.796
11	176.252	186.380
12	186.026	188.492
13	195.673	191.125
14	205.165	194.273
15	214.473	197.927
16	223.572	202.075
17	232.435	206.706
18	241.037	211.807
19	249.352	217.362
20	257.357	223.356
21	265.028	229.771
22	272.343	236.589
23	279.282	243.790
24	285.823	251.353
25	291.949	259.257
26	295.925	265.000

Circle Center At X = 141.854 ; Y = 369.122 ; and Radius = 185.955

Factor of Safety

*** 1.360 ***

Failure Surface Specified By 25 Coordinate Points

Point No.	X-Surf (ft)	Y-Surf (ft)
1	86.667	194.733
2	96.192	191.689
3	105.870	189.171
4	115.671	187.189
5	125.567	185.747
6	135.527	184.851
7	145.521	184.503
8	155.519	184.705
9	165.490	185.454
10	175.406	186.750
11	185.236	188.588

12	194.950	190.963
13	204.518	193.868
14	213.913	197.294
15	223.106	201.230
16	232.069	205.664
17	240.775	210.584
18	249.198	215.975
19	257.312	221.819
20	265.093	228.101
21	272.518	234.800
22	279.563	241.896
23	286.209	249.368
24	292.434	257.194
25	297.972	265.000

Circle Center At X = 146.858 ; Y = 366.608 ; and Radius = 182.110

Factor of Safety

*** 1.361 ***

Failure Surface Specified By 28 Coordinate Points

Point No.	X-Surf (ft)	Y-Surf (ft)
1	60.000	194.200
2	69.327	190.593
3	78.833	187.489
4	88.492	184.899
5	98.275	182.828
6	108.155	181.284
7	118.104	180.271
8	128.092	179.791
9	138.092	179.847
10	148.074	180.436
11	158.011	181.560
12	167.874	183.212
13	177.634	185.390
14	187.263	188.087
15	196.734	191.295
16	206.021	195.006
17	215.095	199.207
18	223.932	203.888
19	232.506	209.035
20	240.792	214.633
21	248.767	220.666
22	256.408	227.117
23	263.693	233.967
24	270.601	241.198
25	277.113	248.787
26	283.209	256.714
27	288.873	264.956
28	288.900	265.000

Circle Center At X = 132.061 ; Y = 366.645 ; and Radius = 186.896

Factor of Safety

*** 1.366 ***

Failure Surface Specified By 28 Coordinate Points

Point No.	X-Surf (ft)	Y-Surf (ft)
1	68.889	194.378
2	78.480	191.548
3	88.188	189.149
4	97.994	187.186
5	107.877	185.661
6	117.818	184.579
7	127.798	183.942
8	137.796	183.750
9	147.793	184.004
10	157.768	184.704
11	167.702	185.848
12	177.576	187.434
13	187.369	189.459
14	197.062	191.918
15	206.635	194.808
16	216.070	198.121

17	225.348	201.852
18	234.450	205.993
19	243.359	210.535
20	252.056	215.471
21	260.525	220.790
22	268.747	226.480
23	276.708	232.532
24	284.391	238.933
25	291.781	245.671
26	298.863	252.731
27	305.623	260.100
28	309.731	265.000

Circle Center At X = 137.094 ; Y = 407.762 ; and Radius = 224.019

Factor of Safety

*** 1.367 ***

Failure Surface Specified By 19 Coordinate Points

Point No.	X-Surf (ft)	Y-Surf (ft)
1	104.444	198.951
2	114.387	200.025
3	124.284	201.452
4	134.125	203.230
5	143.896	205.356
6	153.586	207.829
7	163.181	210.644
8	172.671	213.798
9	182.042	217.287
10	191.284	221.107
11	200.384	225.254
12	209.331	229.720
13	218.113	234.502
14	226.720	239.593
15	235.141	244.987
16	243.365	250.677
17	251.381	256.655
18	259.180	262.914
19	261.598	265.000

Circle Center At X = 79.186 ; Y = 479.198 ; and Radius = 281.383

Factor of Safety

*** 1.374 ***

Failure Surface Specified By 19 Coordinate Points

Point No.	X-Surf (ft)	Y-Surf (ft)
1	104.444	198.951
2	114.394	199.957
3	124.301	201.313
4	134.155	203.018
5	143.942	205.070
6	153.651	207.465
7	163.269	210.202
8	172.785	213.276
9	182.186	216.684
10	191.462	220.422
11	200.599	224.484
12	209.588	228.866
13	218.416	233.563
14	227.074	238.568
15	235.549	243.875
16	243.832	249.478
17	251.912	255.370
18	259.779	261.543
19	263.878	265.000

Circle Center At X = 80.910 ; Y = 481.396 ; and Radius = 283.424

Factor of Safety

*** 1.377 ***

Failure Surface Specified By 25 Coordinate Points

Point No.	X-Surf (ft)	Y-Surf (ft)
1	95.556	194.911
2	105.233	192.393

3	115.025	190.361
4	124.905	188.818
5	134.850	187.770
6	144.835	187.218
7	154.835	187.164
8	164.825	187.609
9	174.780	188.550
10	184.677	189.986
11	194.489	191.913
12	204.194	194.327
13	213.766	197.221
14	223.182	200.588
15	232.419	204.419
16	241.453	208.706
17	250.263	213.438
18	258.826	218.603
19	267.121	224.188
20	275.128	230.178
21	282.826	236.561
22	290.197	243.319
23	297.223	250.435
24	303.885	257.893
25	309.624	265.000

Circle Center At X = 150.914 ; Y = 387.842 ; and Radius = 200.716
 Factor of Safety
 *** 1.377 ***

Failure Surface Specified By 22 Coordinate Points

Point No.	X-Surf (ft)	Y-Surf (ft)
1	131.111	211.111
2	140.229	207.004
3	149.623	203.577
4	159.244	200.848
5	169.038	198.833
6	178.955	197.541
7	188.939	196.981
8	198.937	197.154
9	208.896	198.060
10	218.762	199.695
11	228.481	202.049
12	238.001	205.110
13	247.271	208.860
14	256.241	213.281
15	264.862	218.348
16	273.088	224.034
17	280.875	230.307
18	288.181	237.136
19	294.967	244.481
20	301.195	252.305
21	306.832	260.565
22	309.404	265.000

Circle Center At X = 191.561 ; Y = 332.997 ; and Radius = 136.053
 Factor of Safety
 *** 1.384 ***
 ***** END OF GSTABL7 OUTPUT *****

A-A' / Existing Grade / Search Along Clay / Caissons and Tiebacks

z:\2010\10132-01 south shores church - dana point\engineering\2012_10\alternate design\aa'_4c.pl2 Run By: Username 10/24/2012 03:33PM

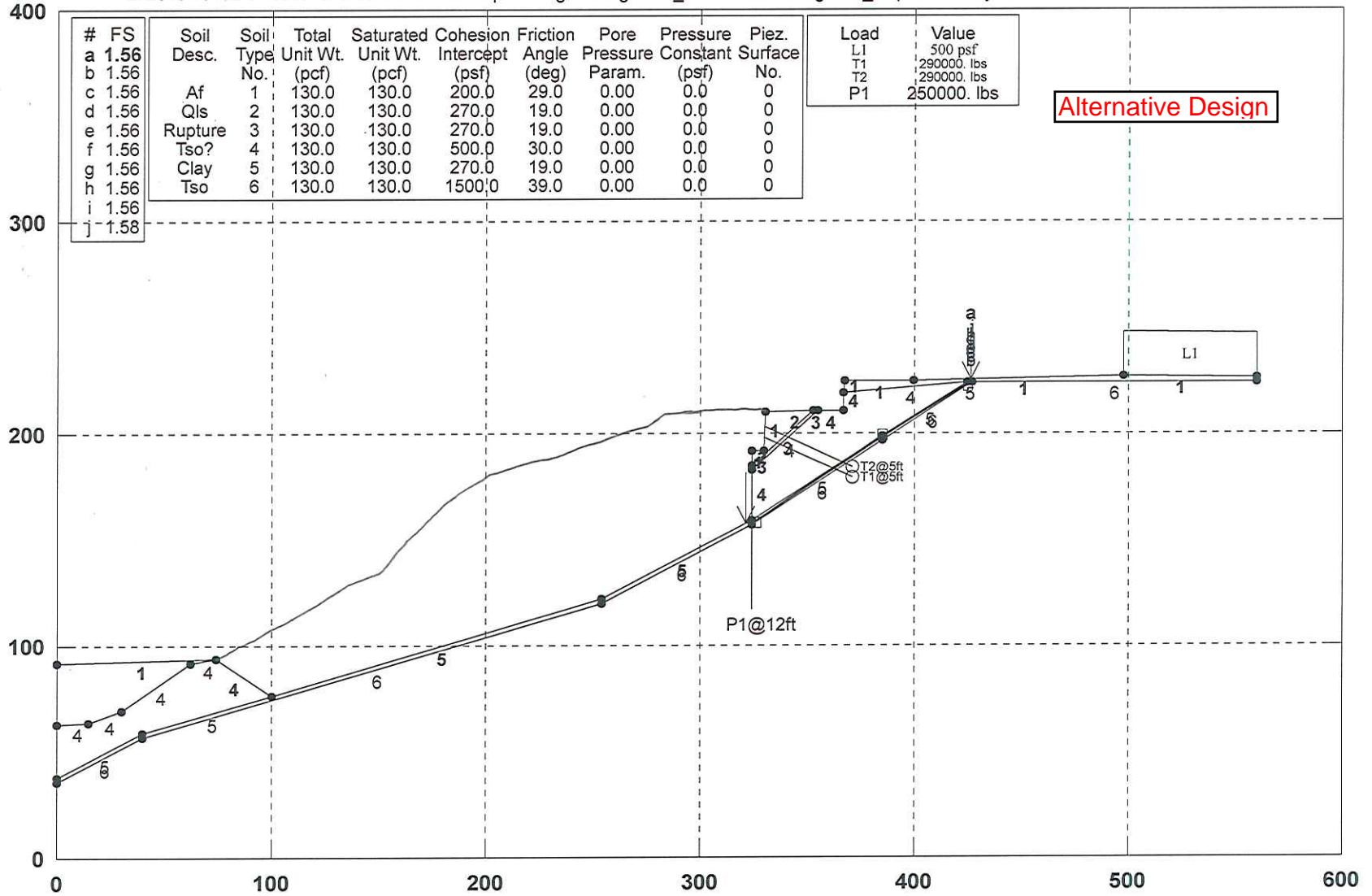

Alternative Design

GSTABL7 v.2 FSmin=1.56

Safety Factors Are Calculated By The Simplified Janbu Method for the case of c & phi both > 0

*** GSTABL7 ***

** GSTABL7 by Dr. Garry H. Gregory, Ph.D., P.E., D.GE **
** Original Version 1.0, January 1996; Current Ver. 2.005.2, Jan. 2011 **
(All Rights Reserved-Unauthorized Use Prohibited)

SLOPE STABILITY ANALYSIS SYSTEM

Modified Bishop, Simplified Janbu, or GLE Method of Slices.
(Includes Spencer & Morgenstern-Price Type Analysis)
Including Pier/Pile, Reinforcement, Soil Nail, Tieback,
Nonlinear Undrained Shear Strength, Curved Phi Envelope,
Anisotropic Soil, Fiber-Reinforced Soil, Boundary Loads, Water
Surfaces, Pseudo-Static & Newmark Earthquake, and Applied Forces.

Analysis Run Date: 10/24/2012
Time of Run: 03:33PM
Run By: Username
Input Data Filename: Z:\2010\10132-01 South Shores Church - Dana Point\Engineerin
g\2012_10\Alternate Design\aa'_4c.
Output Filename: Z:\2010\10132-01 South Shores Church - Dana Point\Engineerin
g\2012_10\Alternate Design\aa'_4c.OUT
Unit System: English
Plotted Output Filename: Z:\2010\10132-01 South Shores Church - Dana Point\Engineerin
g\2012_10\Alternate Design\aa'_4c.PLT

PROBLEM DESCRIPTION: A-A' / Existing Grade / Search Along
Clay / Caissons and Tiebacks

BOUNDARY COORDINATES
17 Top Boundaries
35 Total Boundaries

Table with columns: Boundary No., X-Left (ft), Y-Left (ft), X-Right (ft), Y-Right (ft), Soil Type Below Bnd. Rows 1-35.

Default Y-Origin = 0.00(ft)
Default X-Plus Value = 0.00(ft)
Default Y-Plus Value = 0.00(ft)

ISOTROPIC SOIL PARAMETERS

6 Type(s) of Soil

Table with columns: Soil Type, Total Unit Wt. (pcf), Saturated Unit Wt. (pcf), Cohesion Intercept (psf), Friction Angle (deg), Pore Pressure Param. (psf), Piez. Constant (psf), Surface No. Rows 1-6.

BOUNDARY LOAD(S)

Table with columns: Load No., X-Left (ft), X-Right (ft), Intensity (psf), Deflection (deg). Row 1.

NOTE - Intensity Is Specified As A Uniformly Distributed Force Acting On A Horizontally Projected Surface.

TIEBACK LOAD(S)

2 Tieback Load(s) Specified

Table with columns: Tieback No., X-Pos (ft), Y-Pos (ft), Load (lbs), Spacing (ft), Inclination (deg), Length (ft), Force Method. Rows 1-2.

NOTE - An Equivalent Line Load Is Calculated For Each Row Of Tiebacks Assuming A Uniform Distribution Of Load Horizontally Between Individual Tiebacks. Force Method 1 Considers Only Tangential Tieback Forces. Force Method 2 Considers Both Tangential and Normal Tieback Forces. Force Method 3 Considers Only Normal Tieback Forces. Force Method 4 Limits Normal and Tangential Tieback-Force Distribution to 1.5 Times the Tieback Inclination, or to 30 Degrees Below (Left of) the Tieback-Failure Surface Intersection, Whichever is Greater.

PIER/PILE LOAD(S)

1 Pier/Pile Load(s) Specified

Table with columns: Pier/Pile No., X-Pos (ft), Y-Pos (ft), Load (lbs), Spacing (ft), Inclination (deg), Length (ft). Row 1.

NOTE - An Equivalent Line Load Is Calculated For Each Row Of Piers/Piles Assuming A Uniform Distribution Of Load Horizontally Between Individual Piers/Piles.

Janbus Empirical Coef is being used for the case of c & phi both > 0
A Critical Failure Surface Searching Method, Using A Random Technique For Generating Sliding Block Surfaces, Has Been Specified.

5000 Trial Surfaces Have Been Generated.

3 Boxes Specified For Generation Of Central Block Base Length Of Line Segments For Active And Passive Portions Of Sliding Block Is 80.0

Table with columns: Box No., X-Left (ft), Y-Left (ft), X-Right (ft), Y-Right (ft), Height (ft). Rows 1-3.

The Factor Of Safety For The Trial Failure Surface Defined By The Coordinates Listed Below Is Misleading.

Failure Surface Defined By 5 Coordinate Points

Table with columns: Point No., X-Surf (ft), Y-Surf (ft). Rows 1-5.

Factor Of Safety For The Preceding Specified Surface = -5.967

The Factor Of Safety For The Trial Failure Surface Defined By The Coordinates Listed Below Is Misleading.

Failure Surface Defined By 5 Coordinate Points

Table with columns: Point No., X-Surf (ft), Y-Surf (ft). Rows 1-3.

4 423.44 220.63
 5 423.45 225.48
 Factor Of Safety For The Preceding Specified Surface = -5.967
 The Factor Of Safety For The Trial Failure Surface Defined
 By The Coordinates Listed Below Is Misleading.
 Failure Surface Defined By 5 Coordinate Points
 Point X-Surf Y-Surf
 No. (ft) (ft)
 1 324.01 161.57
 2 327.59 159.49
 3 385.13 198.29
 4 423.44 220.63
 5 423.45 225.48
 Factor Of Safety For The Preceding Specified Surface = -5.967
 The Factor Of Safety For The Trial Failure Surface Defined
 By The Coordinates Listed Below Is Misleading.
 Failure Surface Defined By 5 Coordinate Points
 Point X-Surf Y-Surf
 No. (ft) (ft)
 1 324.01 161.57
 2 327.59 159.49
 3 385.13 198.29
 4 423.44 220.63
 5 423.45 225.48
 Factor Of Safety For The Preceding Specified Surface = -5.967
 The Factor Of Safety For The Trial Failure Surface Defined
 By The Coordinates Listed Below Is Misleading.
 Failure Surface Defined By 5 Coordinate Points
 Point X-Surf Y-Surf
 No. (ft) (ft)
 1 324.01 161.57
 2 327.59 159.49
 3 385.13 198.29
 4 423.44 220.63
 5 423.45 225.48
 Factor Of Safety For The Preceding Specified Surface = -5.967
 The Factor Of Safety For The Trial Failure Surface Defined
 By The Coordinates Listed Below Is Misleading.
 Failure Surface Defined By 5 Coordinate Points
 Point X-Surf Y-Surf
 No. (ft) (ft)
 1 324.01 161.57
 2 327.59 159.49
 3 385.13 198.29
 4 423.44 220.63
 5 423.45 225.48
 Factor Of Safety For The Preceding Specified Surface = -5.967
 The Factor Of Safety For The Trial Failure Surface Defined
 By The Coordinates Listed Below Is Misleading.
 Failure Surface Defined By 5 Coordinate Points
 Point X-Surf Y-Surf
 No. (ft) (ft)
 1 324.01 161.57
 2 327.59 159.49
 3 385.13 198.29
 4 423.44 220.63
 5 423.45 225.48
 Factor Of Safety For The Preceding Specified Surface = -5.967
 The Factor Of Safety For The Trial Failure Surface Defined

By The Coordinates Listed Below Is Misleading.
 Failure Surface Defined By 5 Coordinate Points
 Point X-Surf Y-Surf
 No. (ft) (ft)
 1 324.01 161.57
 2 327.59 159.49
 3 385.13 198.29
 4 423.44 220.63
 5 423.45 225.48
 Factor Of Safety For The Preceding Specified Surface = -5.967
 The Factor Of Safety For The Trial Failure Surface Defined
 By The Coordinates Listed Below Is Misleading.
 Failure Surface Defined By 5 Coordinate Points
 Point X-Surf Y-Surf
 No. (ft) (ft)
 1 324.01 161.57
 2 327.59 159.49
 3 385.13 198.29
 4 423.44 220.63
 5 423.45 225.48
 Factor Of Safety For The Preceding Specified Surface = -5.967
 Following Are Displayed The Ten Most Critical Of The Trial
 Failure Surfaces Evaluated. They Are
 Ordered - Most Critical First.
 * * Safety Factors Are Calculated By The Simplified Janbu Method * *
 Total Number of Trial Surfaces Attempted = 5000
 Number of Trial Surfaces with Misleading FS = 10
 Number of Trial Surfaces With Valid FS = 4990
 Percentage of Trial Surfaces With Non-Valid FS Solutions
 of the Total Attempted = 0.2 %
 Statistical Data On All Valid FS Values:
 FS Max = 30.800 FS Min = 1.564 FS Ave = 2.906
 Standard Deviation = 1.415 Coefficient of Variation = 48.70 %
 Failure Surface Specified By 5 Coordinate Points
 Point X-Surf Y-Surf
 No. (ft) (ft)
 1 321.647 157.756
 2 324.128 157.314
 3 384.729 198.380
 4 424.602 223.613
 5 426.276 225.536
 Factor of Safety
 *** 1.564 ***
 Individual data on the 19 slices

Slice No.	Width (ft)	Weight (lbs)	Water Force (lbs)		Tie Norm (lbs)	Tie Tan (lbs)	Earthquake Force (lbs)		Surcharge Load (lbs)
			Top	Bot			Hor	Ver	
1	2.4	254.5	0.0	0.0	0.0	0.0	0.0	0.0	0.0
2	0.1	177.7	0.0	0.0	0.0	0.0	0.0	0.0	0.0
3	0.0	94.8	0.0	0.0	0.0	0.0	0.0	0.0	0.0
4	0.1	251.9	0.0	0.0	0.0	0.0	0.0	0.0	0.0
5	0.1	404.2	0.0	0.0	0.0	0.0	0.0	0.0	0.0
6	5.7	24185.2	0.0	0.0	0.0	0.0	0.0	0.0	0.0
7	0.1	515.8	0.0	0.0	71.0	0.0	0.0	0.0	0.0
8	22.9	123189.8	0.0	0.0	37363.0	0.0	0.0	0.0	0.0
9	2.0	8695.4	0.0	0.0	4388.0	965.0	0.0	0.0	0.0
10	12.0	44772.6	0.0	0.0	23545.0	11269.0	0.0	0.0	0.0
11	0.1	371.8	0.0	0.0	162.0	113.0	0.0	0.0	0.0
12	0.1	462.0	0.0	0.0	161.0	114.0	0.0	0.0	0.0
13	17.5	74197.0	0.0	0.0	19866.0	20457.0	0.0	0.0	0.0
14	0.3	934.0	0.0	0.0	199.0	289.0	0.0	0.0	0.0
15	15.0	42320.2	0.0	0.0	8176.0	14225.0	0.0	0.0	0.0
16	24.6	30135.7	0.0	0.0	6885.0	17147.0	0.0	0.0	0.0
17	0.3	59.6	0.0	0.0	105.0	157.0	0.0	0.0	0.0
18	0.1	13.8	0.0	0.0	27.0	41.0	0.0	0.0	0.0
19	1.3	132.1	0.0	0.0	519.0	790.0	0.0	0.0	0.0

 Failure Surface Specified By 5 Coordinate Points
 Point X-Surf Y-Surf
 No. (ft) (ft)

A-A' / Existing Grade / Search Along Clay / Caissons and Tiebacks / Pseudo

z:\2010\10132-01 south shores church - dana point\engineering\2012_10\alternate design\aa'_4cp.pl2 Run By: Username 10/24/2012 02:56PM

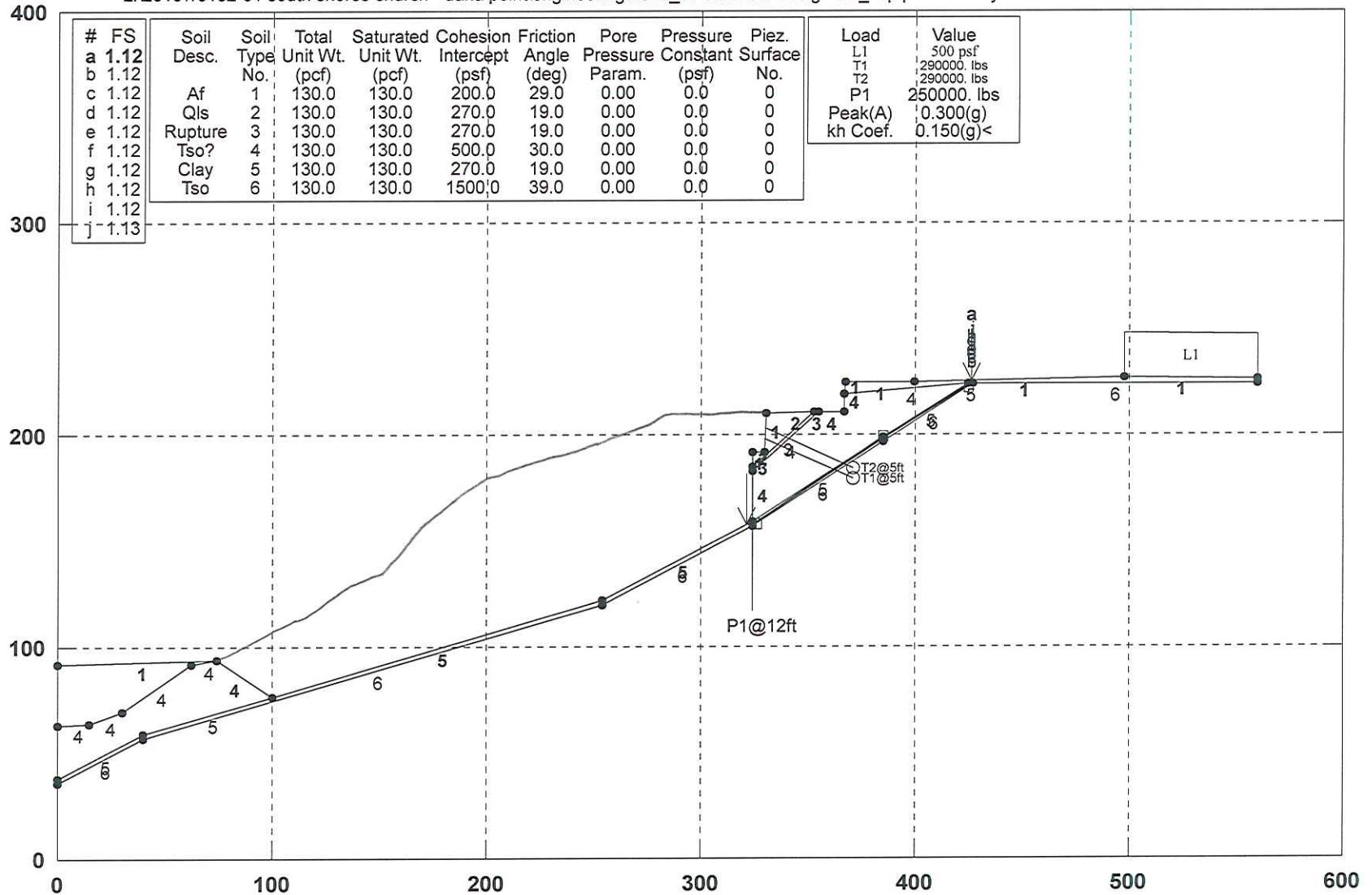

GSTABL7 v.2 FSmin=1.12

Safety Factors Are Calculated By The Simplified Janbu Method for the case of c & phi both > 0

*** GSTABL7 ***

** GSTABL7 by Dr. Garry H. Gregory, Ph.D., P.E., D.GE **

** Original Version 1.0, January 1996; Current Ver. 2.005.2, Jan. 2011 **
(All Rights Reserved-Unauthorizd Use Prohibited)

SLOPE STABILITY ANALYSIS SYSTEM

Modified Bishop, Simplified Janbu, or GLE Method of Slices.

(Includes Spencer & Morgenstern-Price Type Analysis)

Including Pier/Pile, Reinforcement, Soil Nail, Tieback,

Nonlinear Undrained Shear Strength, Curved Phi Envelope,

Anisotropic Soil, Fiber-Reinforced Soil, Boundary Loads, Water

Surfaces, Pseudo-Static & Newmark Earthquake, and Applied Forces.

Analysis Run Date: 10/24/2012

Time of Run: 02:56PM

Run By: Username

Input Data Filename: Z:\2010\10132-01 South Shores Church - Dana Point\Engineerin

g\2012_10\Alternate Design\aa'_4cp.

Output Filename: Z:\2010\10132-01 South Shores Church - Dana Point\Engineerin

g\2012_10\Alternate Design\aa'_4cp.OUT

Unit System: English

Plotted Output Filename: Z:\2010\10132-01 South Shores Church - Dana Point\Engineerin

g\2012_10\Alternate Design\aa'_4cp.PLT

PROBLEM DESCRIPTION: A-A' / Existing Grade / Search Along
Clay / Caissons and Tiebacks / Pseudo

BOUNDARY COORDINATES

17 Top Boundaries

35 Total Boundaries

Boundary No.	X-Left (ft)	Y-Left (ft)	X-Right (ft)	Y-Right (ft)	Soil Type Below Bnd
1	0.00	92.00	74.00	94.00	1
2	74.00	94.00	100.00	76.60	4
3	100.00	76.60	254.00	122.00	5
4	254.00	122.00	324.00	159.00	5
5	324.00	159.00	324.10	183.00	4
6	324.10	183.00	324.20	185.00	3
7	324.20	185.00	324.30	192.00	2
8	324.30	192.00	330.00	192.00	1
9	330.00	192.00	330.10	210.00	1
10	330.10	210.00	353.00	211.00	2
11	353.00	211.00	355.00	211.00	3
12	355.00	211.00	367.00	211.00	4
13	367.00	211.00	367.10	219.00	4
14	367.10	219.00	367.20	225.00	1
15	367.20	225.00	400.00	225.00	1
16	400.00	225.00	498.00	227.00	1
17	498.00	227.00	560.00	226.00	1
18	367.10	219.00	425.00	224.00	4
19	425.00	224.00	427.00	224.00	5
20	427.00	224.00	560.00	224.00	6
21	0.00	63.00	15.00	64.00	4
22	15.00	64.00	30.00	69.00	4
23	30.00	69.00	62.00	92.00	4
24	62.00	92.00	74.00	94.00	4
25	324.20	185.00	353.00	211.00	3
26	324.10	183.00	355.00	211.00	4
27	0.00	38.00	40.00	59.00	5
28	40.00	59.00	100.00	76.60	5
29	324.00	159.00	385.00	199.00	5
30	385.00	199.00	425.00	224.00	5
31	0.00	36.00	40.00	57.00	6
32	40.00	57.00	254.00	120.00	6
33	254.00	120.00	324.00	157.00	6
34	324.00	157.00	385.00	197.00	6
35	385.00	197.00	427.00	224.00	6

Default Y-Origin = 0.00(ft)

Default X-Plus Value = 0.00(ft)

Default Y-Plus Value = 0.00(ft)

ISOTROPIC SOIL PARAMETERS

6 Type(s) of Soil

Soil Type No.	Total Unit Wt. (pcf)	Saturated Unit Wt. (pcf)	Cohesion Intercept (psf)	Friction Angle (deg)	Pore Pressure Param. (psf)	Pressure Constant (psf)	Piez. Surface No.
1	130.0	130.0	200.0	29.0	0.00	0.0	0
2	130.0	130.0	270.0	19.0	0.00	0.0	0
3	130.0	130.0	270.0	19.0	0.00	0.0	0
4	130.0	130.0	500.0	30.0	0.00	0.0	0
5	130.0	130.0	270.0	19.0	0.00	0.0	0
6	130.0	130.0	1500.0	39.0	0.00	0.0	0

BOUNDARY LOAD(S)

1 Load(s) Specified

Load No.	X-Left (ft)	X-Right (ft)	Intensity (psf)	Deflection (deg)
1	498.00	560.00	500.0	0.0

NOTE - Intensity Is Specified As A Uniformly Distributed

Force Acting On A Horizontally Projected Surface.

Specified Peak Ground Acceleration Coefficient (A) = 0.300(g)

Specified Horizontal Earthquake Coefficient (kh) = 0.150(g)

Specified Vertical Earthquake Coefficient (kv) = 0.000(g)

Specified Seismic Pore-Pressure Factor = 0.000

TIEBACK LOAD(S)

2 Tieback Load(s) Specified

Tieback No.	X-Pos (ft)	Y-Pos (ft)	Load (lbs)	Spacing (ft)	Inclination (deg)	Length (ft)	Force Method
1	330.03	198.00	290000.0	5.0	25.00	45.0	2
2	330.06	203.00	290000.0	5.0	25.00	45.0	2

NOTE - An Equivalent Line Load Is Calculated For Each Row Of Tiebacks

Assuming A Uniform Distribution Of Load Horizontally Between Individual

Tiebacks. Force Method 1 Considers Only Tangential Tieback Forces.

Force Method 2 Considers Both Tangential and Normal Tieback Forces.

Force Method 3 Considers Only Normal Tieback Forces.

Force Method 4 Limits Normal and Tangential Tieback-Force Distribution

to 1.5 Times The Tieback Inclination, or to 30 Degrees Below (Left of)

the Tieback-Failure Surface Intersection, Whichever is Greater.

PIER/PILE LOAD(S)

1 Pier/Pile Load(s) Specified

Pier/Pile No.	X-Pos (ft)	Y-Pos (ft)	Load (lbs)	Spacing (ft)	Inclination (deg)	Length (ft)
1	324.40	192.00	250000.0	12.0	90.00	75.0

NOTE - An Equivalent Line Load Is Calculated For Each Row Of Piers/Piles

Assuming A Uniform Distribution Of Load Horizontally Between

Individual Piers/Piles.

Janbus Empirical Coef is being used for the case of c & phi both > 0

A Critical Failure Surface Searching Method, Using A Random

Technique For Generating Sliding Block Surfaces, Has Been

Specified.

5000 Trial Surfaces Have Been Generated.

3 Boxes Specified For Generation Of Central Block Base

Length Of Line Segments For Active And Passive Portions Of

Sliding Block Is 80.0

Box No.	X-Left (ft)	Y-Left (ft)	X-Right (ft)	Y-Right (ft)	Height (ft)
1	324.10	158.00	328.10	158.00	5.00
2	383.00	199.00	387.00	199.00	5.00
3	423.00	222.00	427.00	222.00	5.00

Following Are Displayed The Ten Most Critical Of The Trial

Failure Surfaces Evaluated. They Are

Ordered - Most Critical First.

* * Safety Factors Are Calculated By The Simplified Janbu Method * *

Total Number of Trial Surfaces Attempted = 5000

Number of Trial Surfaces With Valid FS = 5000

Statistical Data On All Valid FS Values:

FS Max = 244.943 FS Min = 1.115 FS Ave = 2.492

Standard Deviation = 10.866 Coefficient of Variation = 436.02 %

Failure Surface Specified By 5 Coordinate Points

Point No.	X-Surf (ft)	Y-Surf (ft)
1	321.647	157.756
2	324.128	157.314
3	384.729	198.380

Slice No.	Width (ft)	Weight (lbs)	Water Force Top (lbs)	Water Force Bot (lbs)	Tie Force Norm (lbs)	Tie Force Tan (lbs)	Earthquake Force Hor (lbs)	Surcharge Ver Load (lbs)
4		424.602		223.613				
5		426.276		225.536				
Factor of Safety								
*** 1.115 ***								
Individual data on the 19 slices								
Water Force Tie Force Earthquake Force Surcharge								
Top Bot Norm Tan Hor Ver Load								
(lbs) (lbs) (lbs) (lbs) (lbs) (lbs) (lbs) (lbs)								
1	2.4	254.5	0.0	0.0	0.0	0.0	38.2	0.0
2	0.1	177.7	0.0	0.0	0.0	0.0	26.7	0.0
3	0.0	94.8	0.0	0.0	0.0	0.0	14.2	0.0
4	0.1	251.9	0.0	0.0	0.0	0.0	37.8	0.0
5	0.1	404.2	0.0	0.0	0.0	0.0	60.6	0.0
6	5.7	24185.2	0.0	0.0	0.0	0.0	3627.8	0.0
7	0.1	515.8	0.0	0.0	71.1	0.0	77.4	0.0
8	22.9	123189.8	0.0	0.0	37363.3	0.0	18478.5	0.0
9	2.0	8695.4	0.0	0.0	4388.8	965.1	1304.3	0.0
10	12.0	44772.6	0.0	0.0	23545.5	11269.7	6715.9	0.0
11	0.1	371.8	0.0	0.0	162.2	113.3	55.8	0.0
12	0.1	462.0	0.0	0.0	161.1	114.4	69.3	0.0
13	17.5	74197.0	0.0	0.0	19866.6	20457.7	11129.6	0.0
14	0.3	934.0	0.0	0.0	199.9	289.1	140.1	0.0
15	15.0	42320.2	0.0	0.0	8176.6	14225.5	6348.0	0.0
16	24.6	30135.7	0.0	0.0	6885.5	17147.7	4520.4	0.0
17	0.3	59.6	0.0	0.0	105.5	157.7	8.9	0.0
18	0.1	13.8	0.0	0.0	27.7	41.1	2.1	0.0
19	1.3	132.1	0.0	0.0	519.9	790.1	19.8	0.0
Failure Surface Specified By 5 Coordinate Points								
Point No.	X-Surf (ft)	Y-Surf (ft)						
1	321.647	157.756						
2	324.128	157.314						
3	384.729	198.380						
4	424.602	223.613						
5	426.276	225.536						
Factor of Safety								
*** 1.115 ***								
Failure Surface Specified By 5 Coordinate Points								
Point No.	X-Surf (ft)	Y-Surf (ft)						
1	321.647	157.756						
2	324.128	157.314						
3	384.729	198.380						
4	424.602	223.613						
5	426.276	225.536						
Factor of Safety								
*** 1.115 ***								
Failure Surface Specified By 5 Coordinate Points								
Point No.	X-Surf (ft)	Y-Surf (ft)						
1	321.647	157.756						
2	324.128	157.314						
3	384.729	198.380						
4	424.602	223.613						
5	426.276	225.536						
Factor of Safety								
*** 1.115 ***								
Failure Surface Specified By 5 Coordinate Points								
Point No.	X-Surf (ft)	Y-Surf (ft)						
1	321.647	157.756						
2	324.128	157.314						
3	384.729	198.380						
4	424.602	223.613						
5	426.276	225.536						
Factor of Safety								
*** 1.115 ***								
Failure Surface Specified By 5 Coordinate Points								
Point No.	X-Surf (ft)	Y-Surf (ft)						
1	321.647	157.756						
2	324.128	157.314						
3	384.729	198.380						
4	424.602	223.613						
5	426.276	225.536						
Factor of Safety								
*** 1.115 ***								

No.	(ft)	(ft)
1	321.647	157.756
2	324.128	157.314
3	384.729	198.380
4	424.602	223.613
5	426.276	225.536
Factor of Safety		
*** 1.115 ***		
Failure Surface Specified By 5 Coordinate Points		
Point No.	X-Surf (ft)	Y-Surf (ft)
1	321.647	157.756
2	324.128	157.314
3	384.729	198.380
4	424.602	223.613
5	426.276	225.536
Factor of Safety		
*** 1.115 ***		
Failure Surface Specified By 5 Coordinate Points		
Point No.	X-Surf (ft)	Y-Surf (ft)
1	321.647	157.756
2	324.128	157.314
3	384.729	198.380
4	424.602	223.613
5	426.276	225.536
Factor of Safety		
*** 1.115 ***		
Failure Surface Specified By 5 Coordinate Points		
Point No.	X-Surf (ft)	Y-Surf (ft)
1	322.559	158.238
2	324.355	157.558
3	383.518	197.764
4	424.454	222.764
5	427.064	225.552
Factor of Safety		
*** 1.125 ***		
**** END OF GSTABL7 OUTPUT ****		

B-B' / Alt Design / Search Along Clay / Caissons and Tiebacks

z:\2010\10132-01 south shores church - dana point\engineering\2013_05\alternate design\bb'1.pl2 Run By: Username 5/8/2013 04:01PM

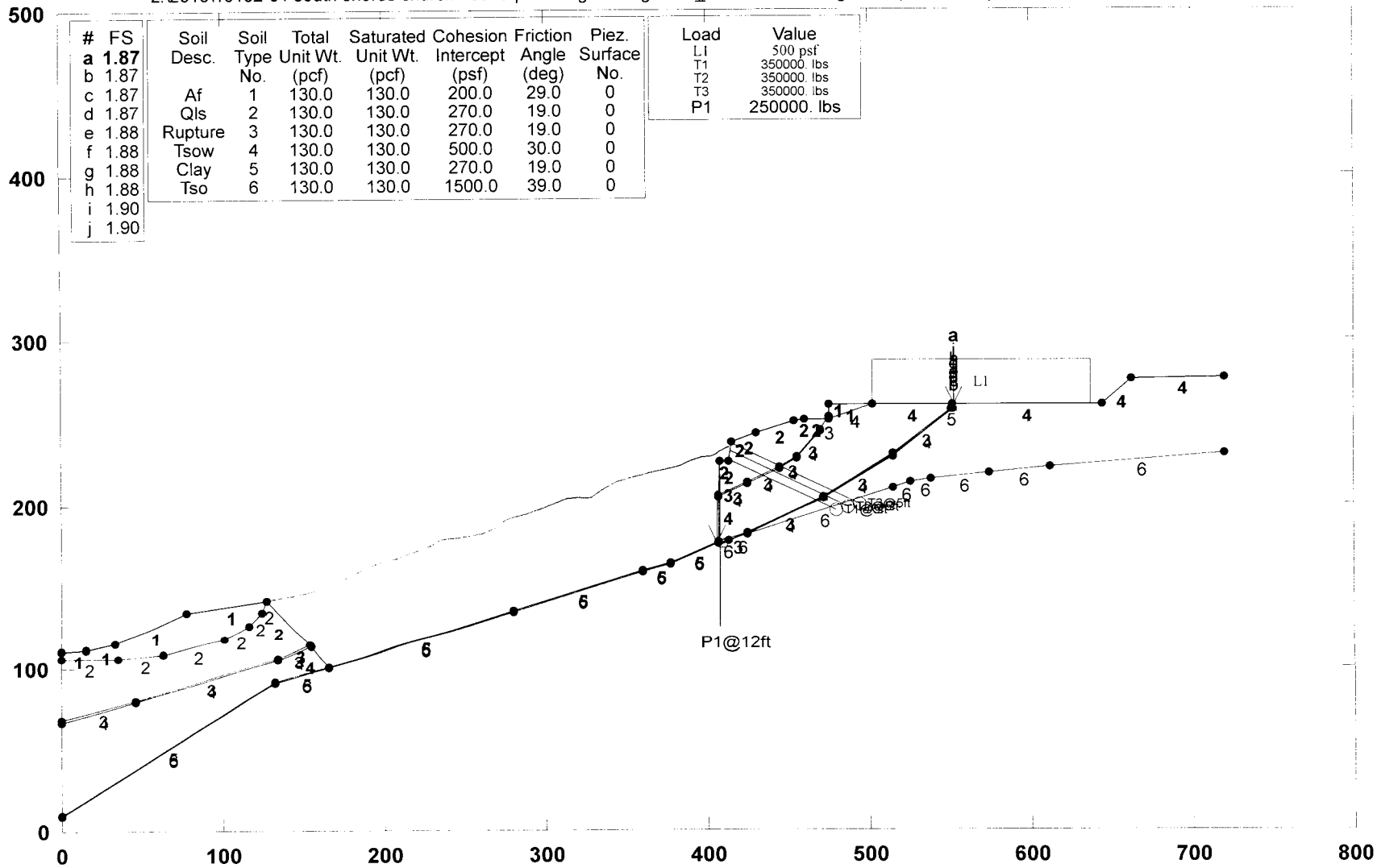

GSTABL7 v.2 FSmin=1.87

Safety Factors Are Calculated By The Simplified Janbu Method for the case of c & phi both > 0

*** GSTABL7 ***

** GSTABL7 by Dr. Garry H. Gregory, Ph.D.,P.E.,D.GE **

** Original Version 1.0, January 1996; Current Ver. 2.005.2, Jan. 2011 **
(All Rights Reserved-Unauthorized Use Prohibited)

SLOPE STABILITY ANALYSIS SYSTEM

Modified Bishop, Simplified Janbu, or GLE Method of Slices.
(Includes Spencer & Morgenstern-Price Type Analysis)
Including Pier/Pile, Reinforcement, Soil Nail, Tieback,
Nonlinear Undrained Shear Strength, Curved Phi Envelope,
Anisotropic Soil, Fiber-Reinforced Soil, Boundary Loads, Water
Surfaces, Pseudo-Static & Newmark Earthquake, and Applied Forces.

Analysis Run Date: 5/8/2013
Time of Run: 04:01PM
Run By: Username
Input Data Filename: Z:\2010\10132-01 South Shores Church - Dana
Point\Engineering\2013_05\Alternate Design\bb'1.
Output Filename: Z:\2010\10132-01 South Shores Church - Dana
Point\Engineering\2013_05\Alternate Design\bb'1.OUT
Unit System: English

Plotted Output Filename: Z:\2010\10132-01 South Shores Church - Dana
Point\Engineering\2013_05\Alternate Design\bb'1.PLT

PROBLEM DESCRIPTION: B-B' / Alt Design / Search Along Clay /
Caissons and Tiebacks

BOUNDARY COORDINATES

26 Top Boundaries
72 Total Boundaries

Boundary No.	X-Left (ft)	Y-Left (ft)	X-Right (ft)	Y-Right (ft)	Soil Type Below Bnd
1	0.00	111.00	15.00	112.00	1
2	15.00	112.00	33.00	115.00	1
3	33.00	115.00	77.00	135.00	1
4	77.00	135.00	127.00	142.00	1
5	127.00	142.00	154.00	114.00	2
6	154.00	114.00	155.00	113.00	3
7	155.00	113.00	166.00	101.00	4
8	166.00	101.00	280.00	136.00	5
9	280.00	136.00	360.00	160.00	5
10	360.00	160.00	377.00	165.00	5
11	377.00	165.00	407.00	177.00	5
12	407.00	177.00	407.10	204.00	4
13	407.10	204.00	407.20	205.00	3
14	407.20	205.00	407.30	226.00	2
15	407.30	226.00	413.00	226.00	2
16	413.00	226.00	415.00	238.00	2
17	415.00	238.00	430.00	243.00	2
18	430.00	243.00	454.00	250.00	2
19	454.00	250.00	460.00	251.00	2
20	460.00	251.00	475.00	251.00	2
21	475.00	251.00	475.10	260.00	1

22	475.10	260.00	502.00	260.00	1
23	502.00	260.00	552.00	260.00	4
24	552.00	260.00	644.00	260.00	4
25	644.00	260.00	662.00	275.00	4
26	662.00	275.00	720.00	276.00	4
27	475.00	251.00	502.00	260.00	4
28	551.00	257.00	552.00	257.00	5
29	407.20	205.00	425.20	213.30	3
30	425.20	213.30	445.00	222.00	3
31	445.00	222.00	455.00	229.00	3
32	455.00	229.00	470.00	245.00	3
33	470.00	245.00	475.00	253.00	3
34	407.10	204.00	425.10	212.30	4
35	425.10	212.30	445.00	221.00	4
36	445.00	221.00	455.00	228.00	4
37	455.00	228.00	470.00	244.00	4
38	0.00	106.00	35.00	106.00	2
39	35.00	106.00	63.00	109.00	2
40	63.00	109.00	101.00	118.00	2
41	101.00	118.00	116.00	127.00	2
42	116.00	127.00	124.00	135.00	2
43	124.00	135.00	127.00	142.00	2
44	0.00	68.00	46.00	80.00	3
45	46.00	80.00	134.00	106.00	3
46	134.00	106.00	154.00	114.00	3
47	0.00	67.00	46.00	79.00	4
48	46.00	79.00	134.00	105.00	4
49	134.00	105.00	155.00	113.00	4
50	0.00	10.00	132.00	92.00	5
51	132.00	92.00	166.00	101.00	5
52	407.00	177.00	425.00	183.00	3
53	425.00	183.00	472.00	204.00	3
54	472.00	204.00	515.00	230.00	3
55	515.00	230.00	551.00	257.00	3
56	0.00	9.00	132.00	91.00	6
57	132.00	91.00	166.00	100.00	6
58	166.00	100.00	280.00	135.00	6
59	280.00	135.00	360.00	159.00	6
60	360.00	159.00	377.00	164.00	6
61	377.00	164.00	407.00	176.00	6
62	407.00	176.00	413.00	178.00	6
63	413.00	178.00	425.00	182.00	6
64	425.00	182.00	472.00	203.00	4
65	472.00	203.00	515.00	229.00	4
66	515.00	229.00	552.00	257.00	4
67	425.00	182.00	515.00	210.00	6
68	515.00	210.00	526.00	213.00	6
69	526.00	213.00	538.00	215.00	6
70	538.00	215.00	574.00	219.00	6
71	574.00	219.00	612.00	222.00	6
72	612.00	222.00	720.00	230.00	6

Default Y-Origin = 0.00(ft)

Default X-Plus Value = 0.00(ft)

Default Y-Plus Value = 0.00(ft)

1

ISOTROPIC SOIL PARAMETERS

6 Type(s) of Soil

Soil Type No.	Total Unit Wt. (pcf)	Saturated Unit Wt. (pcf)	Cohesion Intercept (psf)	Friction Angle (deg)	Pore Pressure Param.	Pressure Constant (psf)	Piez. Surface No.
1	130.0	130.0	200.0	29.0	0.00	0.0	0

2	130.0	130.0	270.0	19.0	0.00	0.0	0
3	130.0	130.0	270.0	19.0	0.00	0.0	0
4	130.0	130.0	500.0	30.0	0.00	0.0	0
5	130.0	130.0	270.0	19.0	0.00	0.0	0
6	130.0	130.0	1500.0	39.0	0.00	0.0	0

1

BOUNDARY LOAD(S)

1 Load(s) Specified

Load No.	X-Left (ft)	X-Right (ft)	Intensity (psf)	Deflection (deg)
1	502.00	637.00	500.0	0.0

NOTE - Intensity Is Specified As A Uniformly Distributed Force Acting On A Horizontally Projected Surface.

1

TIEBACK LOAD(S)

3 Tieback Load(s) Specified

Tieback No.	X-Pos (ft)	Y-Pos (ft)	Load (lbs)	Spacing (ft)	Inclination (deg)	Length (ft)	Force Method
1	413.17	227.00	350000.0	5.0	25.00	73.0	2
2	414.00	232.00	350000.0	5.0	25.00	80.0	2
3	414.83	237.00	350000.0	5.0	25.00	87.0	2

NOTE - An Equivalent Line Load Is Calculated For Each Row Of Tiebacks Assuming A Uniform Distribution Of Load Horizontally Between Individual Tiebacks. Force Method 1 Considers Only Tangential Tieback Forces. Force Method 2 Considers Both Tangential and Normal Tieback Forces. Force Method 3 Considers Only Normal Tieback Forces. Force Method 4 Limits Normal and Tangential Tieback-Force Distribution to 1.5 Times the Tieback Inclination, or to 30 Degrees Below (Left of) the Tieback-Failure Surface Intersection, Whichever is Greater.

1

PIER/PILE LOAD(S)

1 Pier/Pile Load(s) Specified

Pier/Pile No.	X-Pos (ft)	Y-Pos (ft)	Load (lbs)	Spacing (ft)	Inclination (deg)	Length (ft)
1	407.40	226.00	250000.0	12.0	90.00	100.0

NOTE - An Equivalent Line Load Is Calculated For Each Row Of Piers/Piles Assuming A Uniform Distribution Of Load Horizontally Between Individual Piers/Piles.

Janbus Empirical Coef is being used for the case of c & ϕ both > 0

1

A Critical Failure Surface Searching Method, Using A Random Technique For Generating Sliding Block Surfaces, Has Been Specified.

8000 Trial Surfaces Have Been Generated.

4 Boxes Specified For Generation Of Central Block Base

Length Of Line Segments For Active And Passive Portions Of Sliding Block Is 60.0

Box No.	X-Left (ft)	Y-Left (ft)	X-Right (ft)	Y-Right (ft)	Height (ft)
1	407.10	176.50	412.00	176.50	5.00
2	470.00	204.00	474.00	204.00	5.00
3	513.00	230.00	517.00	230.00	5.00
4	550.00	257.00	554.00	257.00	2.00

The Factor Of Safety For The Trial Failure Surface Defined

Following Are Displayed The Ten Most Critical Of The Trial Failure Surfaces Evaluated. They Are Ordered - Most Critical First.

* * Safety Factors Are Calculated By The Simplified Janbu Method * *

Total Number of Trial Surfaces Attempted = 8000

Number of Trial Surfaces with Misleading FS = 4

Number of Trial Failure Surfaces is Greater Than 5000. Statistical Data on FS Values are Not Generated. To Generate Stastical Data, Reduce Number of Trial Failure Surfaces to 5000 or less.

Failure Surface Specified By 6 Coordinate Points

Point No.	X-Surf (ft)	Y-Surf (ft)
1	405.750	176.500
2	407.555	175.150
3	471.823	203.653
4	516.446	230.324
5	551.116	256.453
6	552.342	260.000

Factor of Safety
*** 1.870 ***

Individual data on the 30 slices

Slice No.	Width (ft)	Weight (lbs)	Water Force		Tie Force		Earthquake Force		Surcharge Load (lbs)
			Top (lbs)	Bot (lbs)	Norm (lbs)	Tan (lbs)	Hor (lbs)	Ver (lbs)	
1	0.9	56.6	0.0	0.0	0.	0.	0.0	0.0	0.0

2	0.4	60.0	0.0	0.0	0.	0.	0.0	0.0	0.0
3	0.1	194.6	0.0	0.0	72.	41.	0.0	0.0	0.0
4	0.1	377.6	0.0	0.0	73.	42.	0.0	0.0	0.0
5	0.1	521.5	0.0	0.0	73.	42.	0.0	0.0	0.0
6	0.3	1685.8	0.0	0.0	187.	109.	0.0	0.0	0.0
7	5.4	35136.7	0.0	0.0	4203.	0.	0.0	0.0	0.0
8	2.0	14038.0	0.0	0.0	1930.	0.	0.0	0.0	0.0
9	2.0	15102.3	0.0	0.0	2101.	0.	0.0	0.0	0.0
10	8.0	61594.8	0.0	0.0	11007.	0.	0.0	0.0	0.0
11	0.1	759.8	0.0	0.0	161.	0.	0.0	0.0	0.0
12	0.1	759.6	0.0	0.0	161.	0.	0.0	0.0	0.0
13	4.8	36292.0	0.0	0.0	8405.	0.	0.0	0.0	0.0
14	15.0	110676.4	0.0	0.0	32503.	2746.	0.0	0.0	0.0
15	9.0	64273.9	0.0	0.0	20125.	7036.	0.0	0.0	0.0
16	1.0	7034.7	0.0	0.0	2140.	983.	0.0	0.0	0.0
17	5.0	34633.8	0.0	0.0	10298.	5409.	0.0	0.0	0.0
18	10.0	65485.0	0.0	0.0	18180.	12533.	0.0	0.0	0.0
19	1.8	11316.6	0.0	0.0	2944.	2410.	0.0	0.0	0.0
20	0.2	1088.2	0.0	0.0	326.	213.	0.0	0.0	0.0
21	3.0	18074.4	0.0	0.0	5357.	3675.	0.0	0.0	0.0
22	0.1	649.0	0.0	0.0	173.	124.	0.0	0.0	0.0
23	26.9	162083.1	0.0	0.0	34402.	34641.	0.0	0.0	0.0
24	13.0	58178.2	0.0	0.0	10427.	14947.	0.0	0.0	6500.0
25	1.4	5659.8	0.0	0.0	987.	1567.	0.0	0.0	723.0
26	34.6	74814.5	0.0	0.0	19967.	32301.	0.0	0.0	17277.0
27	0.1	54.1	0.0	0.0	47.	93.	0.0	0.0	58.0
28	0.2	80.4	0.0	0.0	363.	202.	0.0	0.0	94.5
29	0.7	180.2	0.0	0.0	1313.	747.	0.0	0.0	347.5
30	0.3	21.9	0.0	0.0	634.	369.	0.0	0.0	170.8

Failure Surface Specified By 6 Coordinate Points

Point No.	X-Surf (ft)	Y-Surf (ft)
1	405.750	176.500
2	407.555	175.150
3	471.823	203.653
4	516.446	230.324
5	551.116	256.453
6	552.342	260.000

Factor of Safety
 *** 1.870 ***

1

Failure Surface Specified By 6 Coordinate Points

Point No.	X-Surf (ft)	Y-Surf (ft)
1	405.750	176.500
2	407.555	175.150
3	471.823	203.653
4	516.446	230.324
5	551.116	256.453
6	552.342	260.000

Factor of Safety
 *** 1.870 ***

Failure Surface Specified By 6 Coordinate Points

Point No.	X-Surf (ft)	Y-Surf (ft)
1	405.750	176.500
2	407.555	175.150
3	471.823	203.653
4	516.446	230.324
5	551.116	256.453
6	552.342	260.000

Factor of Safety
*** 1.870 ***

1

Failure Surface Specified By 6 Coordinate Points

Point No.	X-Surf (ft)	Y-Surf (ft)
1	406.208	176.683
2	409.285	176.456
3	470.344	202.362
4	513.452	228.779
5	550.981	256.171
6	552.327	260.000

Factor of Safety
*** 1.882 ***

Failure Surface Specified By 6 Coordinate Points

Point No.	X-Surf (ft)	Y-Surf (ft)
1	406.208	176.683
2	409.285	176.456
3	470.344	202.362
4	513.452	228.779
5	550.981	256.171
6	552.327	260.000

Factor of Safety
*** 1.882 ***

1

Failure Surface Specified By 6 Coordinate Points

Point No.	X-Surf (ft)	Y-Surf (ft)
1	406.208	176.683
2	409.285	176.456
3	470.344	202.362

4	513.452	228.779
5	550.981	256.171
6	552.327	260.000

Factor of Safety
 *** 1.882 ***

Failure Surface Specified By 6 Coordinate Points

Point No.	X-Surf (ft)	Y-Surf (ft)
1	406.208	176.683
2	409.285	176.456
3	470.344	202.362
4	513.452	228.779
5	550.981	256.171
6	552.327	260.000

Factor of Safety
 *** 1.882 ***

1

Failure Surface Specified By 6 Coordinate Points

Point No.	X-Surf (ft)	Y-Surf (ft)
1	406.210	176.684
2	408.893	175.938
3	473.712	204.266
4	516.007	229.980
5	552.223	257.120
6	552.906	260.000

Factor of Safety
 *** 1.899 ***

Failure Surface Specified By 6 Coordinate Points

Point No.	X-Surf (ft)	Y-Surf (ft)
1	406.210	176.684
2	408.893	175.938
3	473.712	204.266
4	516.007	229.980
5	552.223	257.120
6	552.906	260.000

Factor of Safety
 *** 1.899 ***

**** END OF GSTABL7 OUTPUT ****

B-B' / Alt Design / Search Along Clay / Caissons and Tiebacks / Pseudostatic

z:\2010\10132-01 south shores church - dana point\engineering\2013_05\alternate design\bb'1p.pl2 Run By: Username 5/9/2013 06:50AM

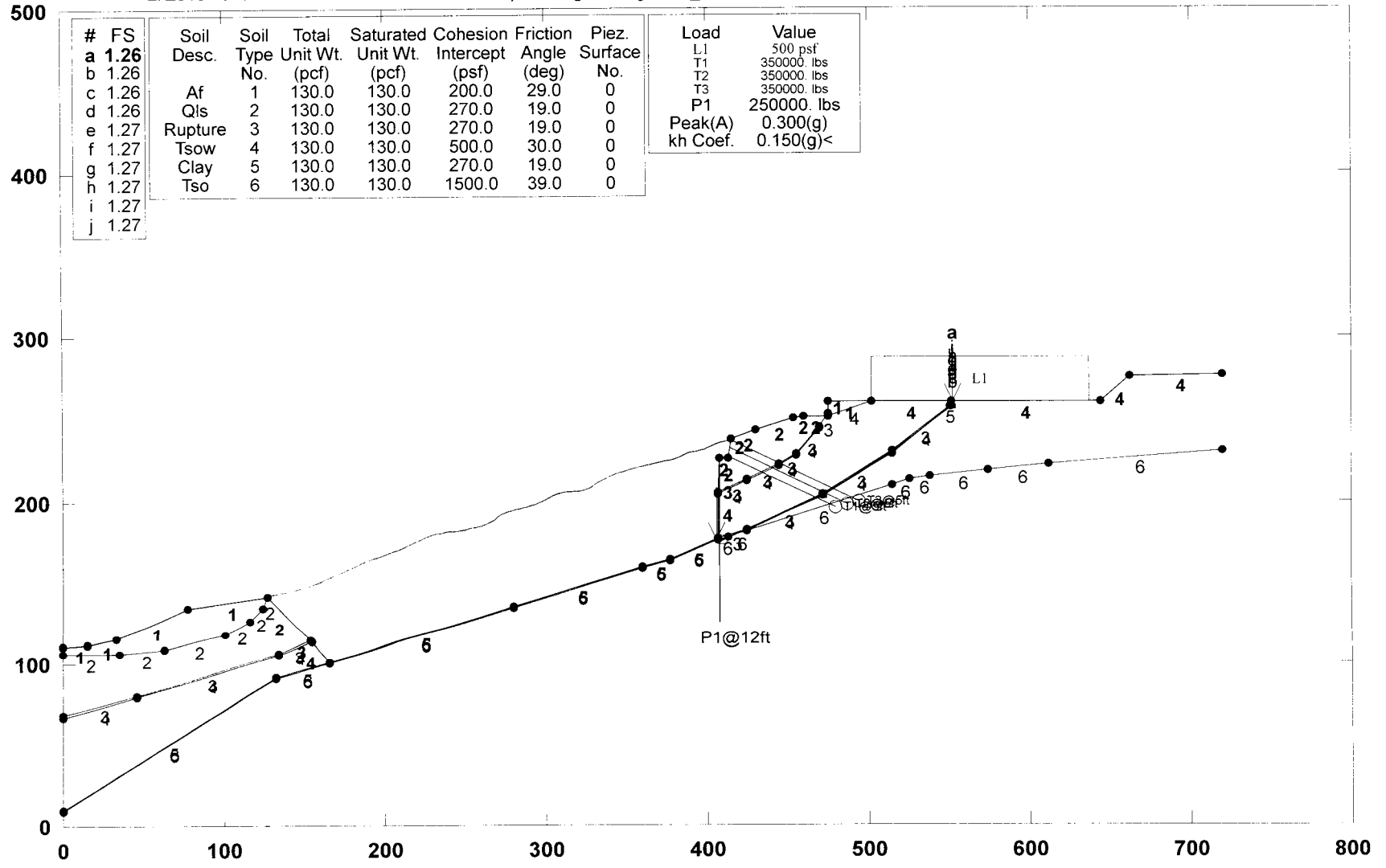

GSTABL7 v.2 FSmin=1.26

Safety Factors Are Calculated By The Simplified Janbu Method for the case of c & phi both > 0

*** GSTABL7 ***

** GSTABL7 by Dr. Garry H. Gregory, Ph.D.,P.E.,D.GE **

** Original Version 1.0, January 1996; Current Ver. 2.005.2, Jan. 2011 **
(All Rights Reserved-Unauthorized Use Prohibited)

SLOPE STABILITY ANALYSIS SYSTEM
Modified Bishop, Simplified Janbu, or GLE Method of Slices.
(Includes Spencer & Morgenstern-Price Type Analysis)
Including Pier/Pile, Reinforcement, Soil Nail, Tieback,
Nonlinear Undrained Shear Strength, Curved Phi Envelope,
Anisotropic Soil, Fiber-Reinforced Soil, Boundary Loads, Water
Surfaces, Pseudo-Static & Newmark Earthquake, and Applied Forces.

Analysis Run Date: 5/9/2013
Time of Run: 06:50AM
Run By: Username
Input Data Filename: Z:\2010\10132-01 South Shores Church - Dana
Point\Engineering\2013_05\Alternate Design\bb'lp.
Output Filename: Z:\2010\10132-01 South Shores Church - Dana
Point\Engineering\2013_05\Alternate Design\bb'lp.OUT
Unit System: English

Plotted Output Filename: Z:\2010\10132-01 South Shores Church - Dana
Point\Engineering\2013_05\Alternate Design\bb'lp.PLT

PROBLEM DESCRIPTION: B-B' / Alt Design / Search Along Clay /
Caissons and Tiebacks / Pseudostatic

BOUNDARY COORDINATES

26 Top Boundaries
72 Total Boundaries

Boundary No.	X-Left (ft)	Y-Left (ft)	X-Right (ft)	Y-Right (ft)	Soil Type Below Bnd
1	0.00	111.00	15.00	112.00	1
2	15.00	112.00	33.00	115.00	1
3	33.00	115.00	77.00	135.00	1
4	77.00	135.00	127.00	142.00	1
5	127.00	142.00	154.00	114.00	2
6	154.00	114.00	155.00	113.00	3
7	155.00	113.00	166.00	101.00	4
8	166.00	101.00	280.00	136.00	5
9	280.00	136.00	360.00	160.00	5
10	360.00	160.00	377.00	165.00	5
11	377.00	165.00	407.00	177.00	5
12	407.00	177.00	407.10	204.00	4
13	407.10	204.00	407.20	205.00	3
14	407.20	205.00	407.30	226.00	2
15	407.30	226.00	413.00	226.00	2
16	413.00	226.00	415.00	238.00	2
17	415.00	238.00	430.00	243.00	2
18	430.00	243.00	454.00	250.00	2
19	454.00	250.00	460.00	251.00	2
20	460.00	251.00	475.00	251.00	2
21	475.00	251.00	475.10	260.00	1

22	475.10	260.00	502.00	260.00	1
23	502.00	260.00	552.00	260.00	4
24	552.00	260.00	644.00	260.00	4
25	644.00	260.00	662.00	275.00	4
26	662.00	275.00	720.00	276.00	4
27	475.00	251.00	502.00	260.00	4
28	551.00	257.00	552.00	257.00	5
29	407.20	205.00	425.20	213.30	3
30	425.20	213.30	445.00	222.00	3
31	445.00	222.00	455.00	229.00	3
32	455.00	229.00	470.00	245.00	3
33	470.00	245.00	475.00	253.00	3
34	407.10	204.00	425.10	212.30	4
35	425.10	212.30	445.00	221.00	4
36	445.00	221.00	455.00	228.00	4
37	455.00	228.00	470.00	244.00	4
38	0.00	106.00	35.00	106.00	2
39	35.00	106.00	63.00	109.00	2
40	63.00	109.00	101.00	118.00	2
41	101.00	118.00	116.00	127.00	2
42	116.00	127.00	124.00	135.00	2
43	124.00	135.00	127.00	142.00	2
44	0.00	68.00	46.00	80.00	3
45	46.00	80.00	134.00	106.00	3
46	134.00	106.00	154.00	114.00	3
47	0.00	67.00	46.00	79.00	4
48	46.00	79.00	134.00	105.00	4
49	134.00	105.00	155.00	113.00	4
50	0.00	10.00	132.00	92.00	5
51	132.00	92.00	166.00	101.00	5
52	407.00	177.00	425.00	183.00	3
53	425.00	183.00	472.00	204.00	3
54	472.00	204.00	515.00	230.00	3
55	515.00	230.00	551.00	257.00	3
56	0.00	9.00	132.00	91.00	6
57	132.00	91.00	166.00	100.00	6
58	166.00	100.00	280.00	135.00	6
59	280.00	135.00	360.00	159.00	6
60	360.00	159.00	377.00	164.00	6
61	377.00	164.00	407.00	176.00	6
62	407.00	176.00	413.00	178.00	6
63	413.00	178.00	425.00	182.00	6
64	425.00	182.00	472.00	203.00	4
65	472.00	203.00	515.00	229.00	4
66	515.00	229.00	552.00	257.00	4
67	425.00	182.00	515.00	210.00	6
68	515.00	210.00	526.00	213.00	6
69	526.00	213.00	538.00	215.00	6
70	538.00	215.00	574.00	219.00	6
71	574.00	219.00	612.00	222.00	6
72	612.00	222.00	720.00	230.00	6

Default Y-Origin = 0.00(ft)

Default X-Plus Value = 0.00(ft)

Default Y-Plus Value = 0.00(ft)

1

ISOTROPIC SOIL PARAMETERS

6 Type(s) of Soil

Soil Type No.	Total Unit Wt. (pcf)	Saturated Unit Wt. (pcf)	Cohesion Intercept (psf)	Friction Angle (deg)	Pore Pressure Param.	Pressure Constant (psf)	Piez. Surface No.
1	130.0	130.0	200.0	29.0	0.00	0.0	0

2	130.0	130.0	270.0	19.0	0.00	0.0	0
3	130.0	130.0	270.0	19.0	0.00	0.0	0
4	130.0	130.0	500.0	30.0	0.00	0.0	0
5	130.0	130.0	270.0	19.0	0.00	0.0	0
6	130.0	130.0	1500.0	39.0	0.00	0.0	0

1

BOUNDARY LOAD(S)

1 Load(s) Specified

Load No.	X-Left (ft)	X-Right (ft)	Intensity (psf)	Deflection (deg)
1	502.00	637.00	500.0	0.0

NOTE - Intensity Is Specified As A Uniformly Distributed Force Acting On A Horizontally Projected Surface.

Specified Peak Ground Acceleration Coefficient (A) = 0.300(g)
 Specified Horizontal Earthquake Coefficient (kh) = 0.150(g)
 Specified Vertical Earthquake Coefficient (kv) = 0.000(g)

Specified Seismic Pore-Pressure Factor = 0.000

1

TIEBACK LOAD(S)

3 Tieback Load(s) Specified

Tieback No.	X-Pos (ft)	Y-Pos (ft)	Load (lbs)	Spacing (ft)	Inclination (deg)	Length (ft)	Force Method
1	413.17	227.00	350000.0	5.0	25.00	73.0	2
2	414.00	232.00	350000.0	5.0	25.00	80.0	2
3	414.83	237.00	350000.0	5.0	25.00	87.0	2

NOTE - An Equivalent Line Load Is Calculated For Each Row Of Tiebacks Assuming A Uniform Distribution Of Load Horizontally Between Individual Tiebacks. Force Method 1 Considers Only Tangential Tieback Forces. Force Method 2 Considers Both Tangential and Normal Tieback Forces. Force Method 3 Considers Only Normal Tieback Forces. Force Method 4 Limits Normal and Tangential Tieback-Force Distribution to 1.5 Times the Tieback Inclination, or to 30 Degrees Below (Left of) the Tieback-Failure Surface Intersection, Whichever is Greater.

1

PIER/PILE LOAD(S)

1 Pier/Pile Load(s) Specified

Pier/Pile No.	X-Pos (ft)	Y-Pos (ft)	Load (lbs)	Spacing (ft)	Inclination (deg)	Length (ft)
1	407.40	226.00	250000.0	12.0	90.00	100.0

NOTE - An Equivalent Line Load Is Calculated For Each Row Of Piers/Piles Assuming A Uniform Distribution Of Load Horizontally Between

Individual Piers/Piles.

Janbus Empirical Coef is being used for the case of c & ϕ both > 0

1

A Critical Failure Surface Searching Method, Using A Random Technique For Generating Sliding Block Surfaces, Has Been Specified.

8000 Trial Surfaces Have Been Generated.

4 Boxes Specified For Generation Of Central Block Base

Length Of Line Segments For Active And Passive Portions Of Sliding Block Is 60.0

Box No.	X-Left (ft)	Y-Left (ft)	X-Right (ft)	Y-Right (ft)	Height (ft)
1	407.10	176.50	412.00	176.50	5.00
2	470.00	204.00	474.00	204.00	5.00
3	513.00	230.00	517.00	230.00	5.00
4	550.00	257.00	554.00	257.00	2.00

The Factor Of Safety For The Trial Failure Surface Defined

Following Are Displayed The Ten Most Critical Of The Trial Failure Surfaces Evaluated. They Are Ordered - Most Critical First.

* * Safety Factors Are Calculated By The Simplified Janbu Method * *

Total Number of Trial Surfaces Attempted = 8000

Number of Trial Surfaces with Misleading FS = 4

Number of Trial Failure Surfaces is Greater Than 5000.
Statistical Data on FS Values are Not Generated.
To Generate Stastical Data, Reduce Number of Trial Failure Surfaces to 5000 or less.

Failure Surface Specified By 6 Coordinate Points

Point No.	X-Surf (ft)	Y-Surf (ft)
1	406.208	176.683
2	409.285	176.456
3	470.344	202.362
4	513.452	228.779
5	550.981	256.171
6	552.327	260.000

Factor of Safety
*** 1.257 ***

Individual data on the 33 slices

Slice No.	Width (ft)	Weight (lbs)	Water	Water	Tie	Tie	Earthquake		Surcharge Load (lbs)
			Force Top (lbs)	Force Bot (lbs)	Force Norm (lbs)	Force Tan (lbs)	Force Hor (lbs)	Force Ver (lbs)	
1	0.8	19.3	0.0	0.0	0.	0.	2.9	0.0	0.0
2	0.1	180.4	0.0	0.0	68.	0.	27.1	0.0	0.0
3	0.1	362.5	0.0	0.0	68.	0.	54.4	0.0	0.0
4	0.1	505.5	0.0	0.0	69.	0.	75.8	0.0	0.0
5	1.2	7931.5	0.0	0.0	878.	0.	1189.7	0.0	0.0
6	0.8	4836.7	0.0	0.0	563.	0.	725.5	0.0	0.0
7	3.4	21362.1	0.0	0.0	2744.	0.	3204.3	0.0	0.0
8	0.3	2182.5	0.0	0.0	319.	0.	327.4	0.0	0.0
9	2.0	13921.4	0.0	0.0	1951.	0.	2088.2	0.0	0.0
10	8.6	66013.4	0.0	0.0	11073.	0.	9902.0	0.0	0.0
11	1.5	11007.7	0.0	0.0	2291.	0.	1651.2	0.0	0.0
12	0.1	756.6	0.0	0.0	162.	0.	113.5	0.0	0.0
13	4.8	36175.6	0.0	0.0	8425.	0.	5426.3	0.0	0.0
14	0.5	3457.8	0.0	0.0	869.	0.	518.7	0.0	0.0
15	14.5	107226.1	0.0	0.0	31387.	3323.	16083.9	0.0	0.0
16	9.0	64548.6	0.0	0.0	19847.	7232.	9682.3	0.0	0.0
17	1.0	7077.7	0.0	0.0	2107.	998.	1061.7	0.0	0.0
18	5.0	34886.4	0.0	0.0	10134.	5462.	5233.0	0.0	0.0
19	10.0	66177.8	0.0	0.0	17887.	12562.	9926.7	0.0	0.0
20	0.3	2181.4	0.0	0.0	556.	453.	327.2	0.0	0.0
21	1.7	10358.7	0.0	0.0	3144.	1929.	1553.8	0.0	0.0
22	3.0	18214.8	0.0	0.0	5451.	3613.	2732.2	0.0	0.0
23	0.1	653.3	0.0	0.0	176.	123.	98.0	0.0	0.0
24	26.9	162546.2	0.0	0.0	35150.	34505.	24381.9	0.0	0.0
25	11.5	51704.3	0.0	0.0	9554.	13270.	7755.6	0.0	5726.0
26	1.5	6169.6	0.0	0.0	1316.	1698.	925.4	0.0	774.0
27	33.8	78030.7	0.0	0.0	19521.	32117.	11704.6	0.0	16907.2
28	2.2	1301.3	0.0	0.0	875.	1756.	195.2	0.0	1083.4
29	0.0	9.3	0.0	0.0	36.	20.	1.4	0.0	9.4
30	0.0	4.4	0.0	0.0	17.	10.	0.7	0.0	4.5
31	0.3	115.6	0.0	0.0	498.	281.	17.3	0.0	131.7
32	0.7	185.8	0.0	0.0	1353.	780.	27.9	0.0	363.7
33	0.3	19.8	0.0	0.0	596.	352.	3.0	0.0	163.4

Failure Surface Specified By 6 Coordinate Points

Point No.	X-Surf (ft)	Y-Surf (ft)
1	406.208	176.683
2	409.285	176.456
3	470.344	202.362
4	513.452	228.779
5	550.981	256.171
6	552.327	260.000

Factor of Safety
 *** 1.257 ***

1

Failure Surface Specified By 6 Coordinate Points

Point No.	X-Surf (ft)	Y-Surf (ft)
1	406.208	176.683
2	409.285	176.456

3	470.344	202.362
4	513.452	228.779
5	550.981	256.171
6	552.327	260.000

Factor of Safety
 *** 1.257 ***

Failure Surface Specified By 6 Coordinate Points

Point No.	X-Surf (ft)	Y-Surf (ft)
1	406.208	176.683
2	409.285	176.456
3	470.344	202.362
4	513.452	228.779
5	550.981	256.171
6	552.327	260.000

Factor of Safety
 *** 1.257 ***

1

Failure Surface Specified By 6 Coordinate Points

Point No.	X-Surf (ft)	Y-Surf (ft)
1	405.750	176.500
2	407.555	175.150
3	471.823	203.653
4	516.446	230.324
5	551.116	256.453
6	552.342	260.000

Factor of Safety
 *** 1.266 ***

Failure Surface Specified By 6 Coordinate Points

Point No.	X-Surf (ft)	Y-Surf (ft)
1	405.750	176.500
2	407.555	175.150
3	471.823	203.653
4	516.446	230.324
5	551.116	256.453
6	552.342	260.000

Factor of Safety
 *** 1.266 ***

1

Failure Surface Specified By 6 Coordinate Points

Point No.	X-Surf (ft)	Y-Surf (ft)
1	405.750	176.500
2	407.555	175.150
3	471.823	203.653
4	516.446	230.324
5	551.116	256.453
6	552.342	260.000

Factor of Safety
*** 1.266 ***

Failure Surface Specified By 6 Coordinate Points

Point No.	X-Surf (ft)	Y-Surf (ft)
1	405.750	176.500
2	407.555	175.150
3	471.823	203.653
4	516.446	230.324
5	551.116	256.453
6	552.342	260.000

Factor of Safety
*** 1.266 ***

1

Failure Surface Specified By 6 Coordinate Points

Point No.	X-Surf (ft)	Y-Surf (ft)
1	406.210	176.684
2	408.893	175.938
3	473.712	204.266
4	516.007	229.980
5	552.223	257.120
6	552.906	260.000

Factor of Safety
*** 1.270 ***

Failure Surface Specified By 6 Coordinate Points

Point No.	X-Surf (ft)	Y-Surf (ft)
1	406.210	176.684

2	408.893	175.938
3	473.712	204.266
4	516.007	229.980
5	552.223	257.120
6	552.906	260.000

Factor of Safety
*** 1.270 ***

**** END OF GSTABL7 OUTPUT ****

D-D' / Design / Search Within Tsow /

z:\2010\10132-01 south shores church - dana point\engineering\2012_10\alternate design\dd'_2.pl2 Run By: Username 11/7/2012 10:54AM

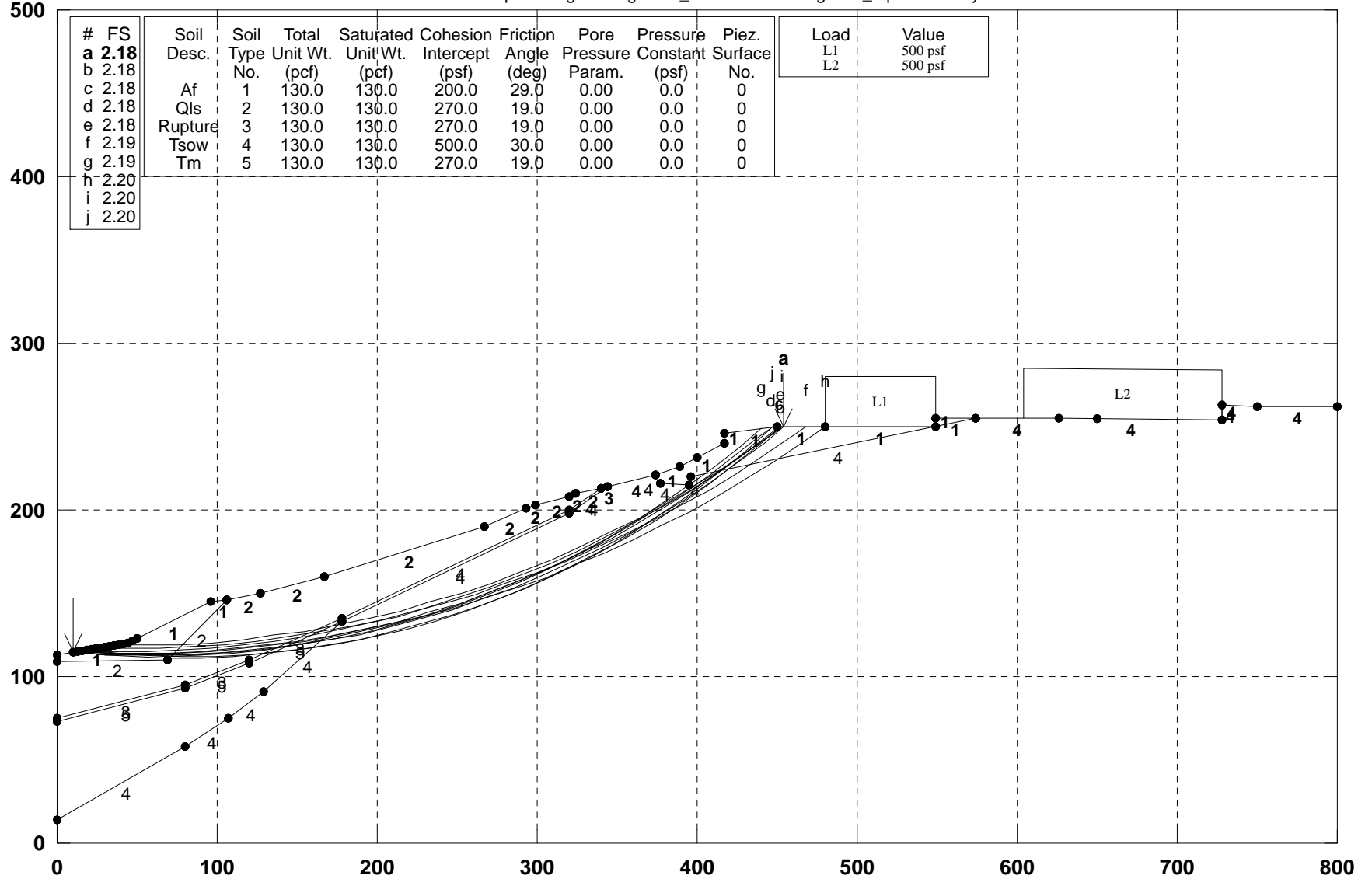

GSTABL7 v.2 FSmin=2.18

Safety Factors Are Calculated By The Modified Bishop Method

*** GSTABL7 ***

** GSTABL7 by Dr. Garry H. Gregory, Ph.D.,P.E.,D.GE **

** Original Version 1.0, January 1996; Current Ver. 2.005.2, Jan. 2011 **
(All Rights Reserved-Unauthorizd Use Prohibited)

SLOPE STABILITY ANALYSIS SYSTEM

Modified Bishop, Simplified Janbu, or GLE Method of Slices.
(Includes Spencer & Morgenstern-Price Type Analysis)
Including Pier/Pile, Reinforcement, Soil Nail, Tieback,
Nonlinear Undrained Shear Strength, Curved Phi Envelope,
Anisotropic Soil, Fiber-Reinforced Soil, Boundary Loads, Water
Surfaces, Pseudo-Static & Newmark Earthquake, and Applied Forces.

Analysis Run Date: 11/7/2012
Time of Run: 10:54AM
Run By: Username
Input Data Filename: Z:\2010\10132-01 South Shores Church - Dana Point\Engineerin
g\2012_10\Alternate Design\dd'_2.
Output Filename: Z:\2010\10132-01 South Shores Church - Dana Point\Engineerin
g\2012_10\Alternate Design\dd'_2.OUT
Unit System: English
Plotted Output Filename: Z:\2010\10132-01 South Shores Church - Dana Point\Engineerin
g\2012_10\Alternate Design\dd'_2.PLT

PROBLEM DESCRIPTION: D-D' / Design / Search Within Tsow /

BOUNDARY COORDINATES
26 Top Boundaries
46 Total Boundaries

Boundary No.	X-Left (ft)	Y-Left (ft)	X-Right (ft)	Y-Right (ft)	Soil Type Below Bnd
1	0.00	113.00	44.00	120.00	1
2	44.00	120.00	96.00	145.00	1
3	96.00	145.00	106.00	146.00	1
4	106.00	146.00	127.00	150.00	2
5	127.00	150.00	167.00	160.00	2
6	167.00	160.00	267.00	190.00	2
7	267.00	190.00	293.00	201.00	2
8	293.00	201.00	299.00	203.00	2
9	299.00	203.00	320.00	208.00	2
10	320.00	208.00	324.00	210.00	2
11	324.00	210.00	340.00	213.00	2
12	340.00	213.00	344.00	214.00	3
13	344.00	214.00	374.00	221.00	4
14	374.00	221.00	389.00	226.00	1
15	389.00	226.00	417.00	240.00	1
16	417.00	240.00	417.00	246.00	1
17	417.10	246.00	450.00	250.00	1
18	450.00	250.00	480.10	250.00	1
19	480.10	250.00	549.00	250.00	1
20	549.00	250.00	549.10	255.00	1
21	549.10	255.00	574.00	255.00	1
22	574.00	255.00	626.00	255.00	4
23	626.00	255.00	728.00	254.00	4
24	728.00	254.00	728.10	263.00	4
25	728.10	263.00	750.00	262.00	4
26	750.00	262.00	800.00	262.00	4
27	0.00	109.00	69.00	110.00	2
28	69.00	110.00	106.00	146.00	2
29	0.00	75.00	80.00	95.00	3
30	80.00	95.00	120.00	110.00	3
31	120.00	110.00	178.00	135.00	3
32	178.00	135.00	320.00	200.00	4
33	320.00	200.00	340.00	213.00	4
34	0.00	73.00	80.00	93.00	5
35	80.00	93.00	120.00	108.00	5
36	120.00	108.00	178.00	133.00	5
37	178.00	133.00	320.00	198.00	4
38	320.00	198.00	344.00	214.00	4
39	0.00	14.00	80.00	58.00	4
40	80.00	58.00	107.00	75.00	4
41	107.00	75.00	129.00	91.00	4

42	129.00	91.00	178.00	133.00	4
43	374.00	221.00	377.00	216.00	4
44	377.00	216.00	395.00	215.00	4
45	395.00	215.00	396.00	220.00	4
46	396.00	220.00	574.00	255.00	4

Default Y-Origin = 0.00(ft)
Default X-Plus Value = 0.00(ft)
Default Y-Plus Value = 0.00(ft)

ISOTROPIC SOIL PARAMETERS

Soil No.	Total (pcf)	Saturated (pcf)	Cohesion (psf)	Friction Angle (deg)	Pore Pressure Param. (psf)	Pressure Constant	Piez. Surface
1	130.0	130.0	200.0	29.0	0.00	0.0	0
2	130.0	130.0	270.0	19.0	0.00	0.0	0
3	130.0	130.0	270.0	19.0	0.00	0.0	0
4	130.0	130.0	500.0	30.0	0.00	0.0	0
5	130.0	130.0	270.0	19.0	0.00	0.0	0

BOUNDARY LOAD(S)

Load No.	X-Left (ft)	X-Right (ft)	Intensity (psf)	Deflection (deg)
1	480.10	549.00	500.0	0.0
2	604.00	728.00	500.0	0.0

NOTE - Intensity Is Specified As A Uniformly Distributed Force Acting On A Horizontally Projected Surface.
A Critical Failure Surface Searching Method, Using A Random Technique For Generating Circular Surfaces, Has Been Specified.
1500 Trial Surfaces Have Been Generated.
100 Surface(s) Initiate(s) From Each Of 15 Points Equally Spaced Along The Ground Surface Between X = 10.00(ft) and X = 50.00(ft)

Each Surface Terminates Between X = 400.00(ft) and X = 650.00(ft)

Unless Further Limitations Were Imposed, The Minimum Elevation At Which A Surface Extends Is Y = 0.00(ft)
20.00(ft) Line Segments Define Each Trial Failure Surface.
Following Are Displayed The Ten Most Critical Of The Trial Failure Surfaces Evaluated. They Are

Ordered - Most Critical First.
* * Safety Factors Are Calculated By The Modified Bishop Method * *

Total Number of Trial Surfaces Attempted = 1500
Number of Trial Surfaces With Valid FS = 1500
Statistical Data On All Valid FS Values:
FS Max = 4.064 FS Min = 2.176 FS Ave = 3.040
Standard Deviation = 0.479 Coefficient of Variation = 15.77 %

Failure Surface Specified By 25 Coordinate Points

Point No.	X-Surf (ft)	Y-Surf (ft)
1	10.000	114.591
2	29.954	113.238
3	49.941	112.523
4	69.941	112.446
5	89.933	113.009
6	109.897	114.209
7	129.813	116.046
8	149.659	118.519
9	169.417	121.624
10	189.065	125.358
11	208.584	129.718
12	227.954	134.699
13	247.155	140.296
14	266.167	146.504
15	284.971	153.315
16	303.549	160.723
17	321.880	168.721
18	339.946	177.300
19	357.730	186.452
20	375.212	196.167
21	392.374	206.436

22 409.200 217.247
 23 425.673 228.590
 24 441.774 240.453
 25 453.901 250.000
 Circle Center At X = 62.335 ; Y = 738.593 ; and Radius = 626.193

Factor of Safety
 *** 2.176 ***

Slice No.	Width (ft)	Weight (lbs)	Water Force		Tie Force		Earthquake Force		Surcharge (lbs)
			Top (lbs)	Bot (lbs)	Norm (lbs)	Tan (lbs)	Hor (lbs)	Ver (lbs)	
1	20.0	5872.4	0.0	0.0	0.0	0.0	0.0	0.0	0.0
2	14.0	10766.1	0.0	0.0	0.0	0.0	0.0	0.0	0.0
3	5.9	6796.3	0.0	0.0	0.0	0.0	0.0	0.0	0.0
4	20.0	39466.6	0.0	0.0	0.0	0.0	0.0	0.0	0.0
5	1.6	4294.1	0.0	0.0	0.0	0.0	0.0	0.0	0.0
6	18.4	59510.9	0.0	0.0	0.0	0.0	0.0	0.0	0.0
7	6.1	23936.5	0.0	0.0	0.0	0.0	0.0	0.0	0.0
8	10.0	41373.8	0.0	0.0	0.0	0.0	0.0	0.0	0.0
9	3.9	16354.2	0.0	0.0	0.0	0.0	0.0	0.0	0.0
10	17.1	74200.4	0.0	0.0	0.0	0.0	0.0	0.0	0.0
11	2.8	12591.2	0.0	0.0	0.0	0.0	0.0	0.0	0.0
12	5.9	26995.8	0.0	0.0	0.0	0.0	0.0	0.0	0.0
13	6.5	30381.1	0.0	0.0	0.0	0.0	0.0	0.0	0.0
14	7.4	35250.7	0.0	0.0	0.0	0.0	0.0	0.0	0.0
15	14.0	68867.2	0.0	0.0	0.0	0.0	0.0	0.0	0.0
16	3.3	16685.4	0.0	0.0	0.0	0.0	0.0	0.0	0.0
17	2.4	12230.8	0.0	0.0	0.0	0.0	0.0	0.0	0.0
18	8.6	44156.2	0.0	0.0	0.0	0.0	0.0	0.0	0.0
19	11.1	58477.9	0.0	0.0	0.0	0.0	0.0	0.0	0.0
20	19.5	106597.3	0.0	0.0	0.0	0.0	0.0	0.0	0.0
21	19.4	108710.7	0.0	0.0	0.0	0.0	0.0	0.0	0.0
22	19.2	109001.9	0.0	0.0	0.0	0.0	0.0	0.0	0.0
23	19.0	107510.8	0.0	0.0	0.0	0.0	0.0	0.0	0.0
24	0.8	4680.1	0.0	0.0	0.0	0.0	0.0	0.0	0.0
25	18.0	102192.9	0.0	0.0	0.0	0.0	0.0	0.0	0.0
26	8.0	46326.2	0.0	0.0	0.0	0.0	0.0	0.0	0.0
27	6.0	34543.9	0.0	0.0	0.0	0.0	0.0	0.0	0.0
28	4.5	25856.1	0.0	0.0	0.0	0.0	0.0	0.0	0.0
29	16.5	89245.3	0.0	0.0	0.0	0.0	0.0	0.0	0.0
30	1.9	9814.4	0.0	0.0	0.0	0.0	0.0	0.0	0.0
31	2.1	11092.1	0.0	0.0	0.0	0.0	0.0	0.0	0.0
32	15.9	78735.3	0.0	0.0	0.0	0.0	0.0	0.0	0.0
33	0.1	248.7	0.0	0.0	0.0	0.0	0.0	0.0	0.0
34	4.0	18274.2	0.0	0.0	0.0	0.0	0.0	0.0	0.0
35	13.7	58333.3	0.0	0.0	0.0	0.0	0.0	0.0	0.0
36	16.3	59496.3	0.0	0.0	0.0	0.0	0.0	0.0	0.0
37	1.2	3996.1	0.0	0.0	0.0	0.0	0.0	0.0	0.0
38	1.8	5812.3	0.0	0.0	0.0	0.0	0.0	0.0	0.0
39	12.0	36149.8	0.0	0.0	0.0	0.0	0.0	0.0	0.0
40	3.4	9395.0	0.0	0.0	0.0	0.0	0.0	0.0	0.0
41	2.6	7190.1	0.0	0.0	0.0	0.0	0.0	0.0	0.0
42	1.0	2704.8	0.0	0.0	0.0	0.0	0.0	0.0	0.0
43	13.2	33967.6	0.0	0.0	0.0	0.0	0.0	0.0	0.0
44	7.8	18370.4	0.0	0.0	0.0	0.0	0.0	0.0	0.0
45	0.1	264.5	0.0	0.0	0.0	0.0	0.0	0.0	0.0
46	3.0	8681.9	0.0	0.0	0.0	0.0	0.0	0.0	0.0
47	5.6	14590.9	0.0	0.0	0.0	0.0	0.0	0.0	0.0
48	16.1	28257.3	0.0	0.0	0.0	0.0	0.0	0.0	0.0
49	8.2	6211.6	0.0	0.0	0.0	0.0	0.0	0.0	0.0
50	3.9	778.6	0.0	0.0	0.0	0.0	0.0	0.0	0.0

Failure Surface Specified By 25 Coordinate Points

Point No.	X-Surf (ft)	Y-Surf (ft)
1	15.714	115.500
2	35.708	114.992
3	55.708	115.066
4	75.697	115.721
5	95.659	116.956

6	115.576	118.772
7	135.433	121.165
8	155.211	124.134
9	174.895	127.677
10	194.467	131.791
11	213.912	136.471
12	233.212	141.715
13	252.352	147.517
14	271.315	153.874
15	290.085	160.778
16	308.647	168.226
17	326.984	176.209
18	345.082	184.722
19	362.925	193.758
20	380.497	203.308
21	397.785	213.365
22	414.773	223.920
23	431.447	234.964
24	447.792	246.489
25	452.477	250.000

Circle Center At X = 43.174 ; Y = 803.041 ; and Radius = 688.089
 Factor of Safety

*** 2.179 ***

Failure Surface Specified By 25 Coordinate Points

Point No.	X-Surf (ft)	Y-Surf (ft)
1	15.714	115.500
2	35.687	114.462
3	55.683	114.055
4	75.682	114.279
5	95.664	115.134
6	115.608	116.619
7	135.496	118.733
8	155.308	121.474
9	175.023	124.839
10	194.622	128.824
11	214.085	133.426
12	233.393	138.639
13	252.528	144.460
14	271.469	150.881
15	290.198	157.897
16	308.696	165.501
17	326.945	173.685
18	344.927	182.440
19	362.623	191.759
20	380.016	201.632
21	397.090	212.048
22	413.826	222.999
23	430.208	234.472
24	446.219	246.456
25	450.655	250.000

Circle Center At X = 58.584 ; Y = 747.668 ; and Radius = 633.620
 Factor of Safety

*** 2.179 ***

Failure Surface Specified By 25 Coordinate Points

Point No.	X-Surf (ft)	Y-Surf (ft)
1	10.000	114.591
2	29.961	113.345
3	49.952	112.747
4	69.952	112.797
5	89.940	113.495
6	109.895	114.840
7	129.795	116.832
8	149.621	119.467
9	169.351	122.744
10	188.964	126.659
11	208.440	131.207
12	227.758	136.384
13	246.899	142.184

14	265.841	148.602
15	284.565	155.630
16	303.052	163.261
17	321.282	171.488
18	339.236	180.301
19	356.894	189.691
20	374.239	199.649
21	391.252	210.163
22	407.915	221.224
23	424.211	232.819
24	440.123	244.936
25	445.702	249.478

Circle Center At X = 58.412 ; Y = 729.689 ; and Radius = 617.000

Factor of Safety

*** 2.181 ***

Failure Surface Specified By 25 Coordinate Points

Point No.	X-Surf (ft)	Y-Surf (ft)
1	10.000	114.591
2	29.913	112.724
3	49.878	111.540
4	69.871	111.042
5	89.871	111.230
6	109.851	112.103
7	129.791	113.660
8	149.665	115.900
9	169.451	118.821
10	189.124	122.417
11	208.664	126.686
12	228.045	131.623
13	247.245	137.221
14	266.243	143.474
15	285.015	150.374
16	303.539	157.914
17	321.794	166.085
18	339.758	174.876
19	357.410	184.278
20	374.729	194.280
21	391.696	204.870
22	408.289	216.035
23	424.490	227.763
24	440.279	240.039
25	452.223	250.000

Circle Center At X = 74.403 ; Y = 694.333 ; and Radius = 583.308

Factor of Safety

*** 2.182 ***

Failure Surface Specified By 25 Coordinate Points

Point No.	X-Surf (ft)	Y-Surf (ft)
1	24.286	116.864
2	44.285	116.673
3	64.282	117.014
4	84.263	117.888
5	104.213	119.294
6	124.119	121.231
7	143.967	123.698
8	163.741	126.691
9	183.429	130.211
10	203.016	134.254
11	222.489	138.816
12	241.833	143.896
13	261.035	149.489
14	280.081	155.592
15	298.958	162.200
16	317.652	169.308
17	336.151	176.911
18	354.440	185.005
19	372.507	193.582
20	390.340	202.638
21	407.925	212.165

22	425.249	222.158
23	442.302	232.608
24	459.070	243.509
25	468.497	250.000

Circle Center At X = 41.455 ; Y = 867.571 ; and Radius = 750.903

Factor of Safety

*** 2.189 ***

Failure Surface Specified By 24 Coordinate Points

Point No.	X-Surf (ft)	Y-Surf (ft)
1	15.714	115.500
2	35.661	114.048
3	55.647	113.285
4	75.647	113.214
5	95.637	113.833
6	115.594	115.142
7	135.494	117.139
8	155.314	119.823
9	175.028	123.189
10	194.615	127.234
11	214.050	131.953
12	233.311	137.341
13	252.374	143.391
14	271.217	150.095
15	289.817	157.446
16	308.152	165.435
17	326.200	174.052
18	343.940	183.288
19	361.350	193.131
20	378.411	203.569
21	395.100	214.590
22	411.399	226.181
23	427.288	238.327
24	440.033	248.788

Circle Center At X = 67.755 ; Y = 691.877 ; and Radius = 578.721

Factor of Safety

*** 2.192 ***

Failure Surface Specified By 26 Coordinate Points

Point No.	X-Surf (ft)	Y-Surf (ft)
1	10.000	114.591
2	29.990	113.965
3	49.990	113.861
4	69.986	114.278
5	89.964	115.216
6	109.910	116.675
7	129.812	118.653
8	149.656	121.149
9	169.428	124.162
10	189.114	127.688
11	208.702	131.727
12	228.178	136.275
13	247.529	141.329
14	266.742	146.886
15	285.803	152.941
16	304.700	159.492
17	323.420	166.532
18	341.950	174.059
19	360.277	182.065
20	378.389	190.547
21	396.275	199.498
22	413.920	208.912
23	431.315	218.783
24	448.446	229.103
25	465.303	239.867
26	480.295	250.000

Circle Center At X = 44.012 ; Y = 880.867 ; and Radius = 767.031

Factor of Safety

*** 2.196 ***

Failure Surface Specified By 24 Coordinate Points

Point No.	X-Surf (ft)	Y-Surf (ft)
1	35.714	118.682
2	55.714	118.714
3	75.705	119.318
4	95.671	120.491
5	115.595	122.233
6	135.461	124.543
7	155.253	127.419
8	174.955	130.858
9	194.551	134.858
10	214.025	139.416
11	233.361	144.527
12	252.543	150.188
13	271.556	156.393
14	290.384	163.139
15	309.012	170.419
16	327.425	178.227
17	345.607	186.557
18	363.545	195.403
19	381.222	204.757
20	398.626	214.612
21	415.742	224.959
22	432.555	235.790
23	449.053	247.096
24	453.041	250.000

Circle Center At X = 44.647 ; Y = 819.081 ; and Radius = 700.456

Factor of Safety
 *** 2.196 ***

Failure Surface Specified By 25 Coordinate Points

Point No.	X-Surf (ft)	Y-Surf (ft)
1	18.571	115.955
2	38.464	113.886
3	58.420	112.550
4	78.410	111.947
5	98.410	112.079
6	118.391	112.946
7	138.327	114.545
8	158.191	116.876
9	177.956	119.935
10	197.595	123.717
11	217.082	128.218
12	236.390	133.432
13	255.494	139.352
14	274.368	145.969
15	292.986	153.274
16	311.323	161.259
17	329.354	169.911
18	347.056	179.220
19	364.403	189.173
20	381.374	199.756
21	397.944	210.955
22	414.092	222.755
23	429.796	235.141
24	445.034	248.094
25	446.674	249.596

Circle Center At X = 84.817 ; Y = 656.402 ; and Radius = 544.493

Factor of Safety
 *** 2.196 ***

**** END OF GSTABL7 OUTPUT ****

D-D' / Design / Search Within Tsow / Pseudostatic

z:\2010\10132-01 south shores church - dana point\engineering\2012_10\alternate design\dd'_2p.pl2 Run By: Username 11/7/2012 10:54AM

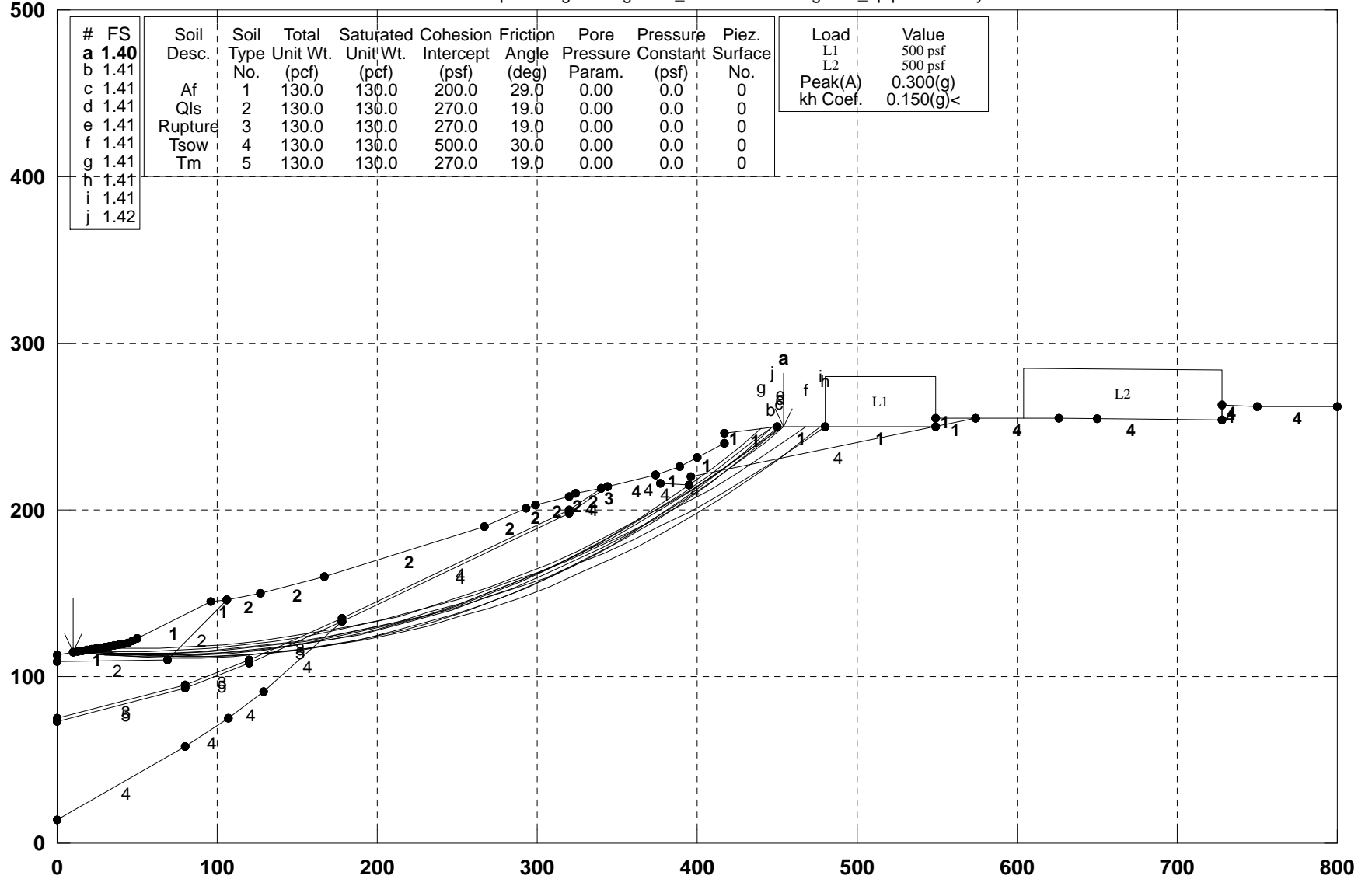

#	FS	Soil Desc.	Soil Type No.	Total Unit Wt. (pcf)	Saturated Unit Wt. (pcf)	Cohesion Intercept (psf)	Friction Angle (deg)	Pore Pressure Param.	Pressure Constant (psf)	Piez. Surface No.
a	1.40									
b	1.41									
c	1.41	Af	1	130.0	130.0	200.0	29.0	0.00	0.0	0
d	1.41	Qls	2	130.0	130.0	270.0	19.0	0.00	0.0	0
e	1.41	Rupture	3	130.0	130.0	270.0	19.0	0.00	0.0	0
f	1.41	Tsow	4	130.0	130.0	500.0	30.0	0.00	0.0	0
g	1.41	Tm	5	130.0	130.0	270.0	19.0	0.00	0.0	0
h	1.41									
i	1.41									
j	1.42									

Load	Value
L1	500 psf
L2	500 psf
Peak(A)	0.300(g)
kh Coef.	0.150(g)<

GSTABL7 v.2 FSmin=1.40
Safety Factors Are Calculated By The Modified Bishop Method

*** GSTABL7 ***

** GSTABL7 by Dr. Garry H. Gregory, Ph.D.,P.E.,D.GE **

** Original Version 1.0, January 1996; Current Ver. 2.005.2, Jan. 2011 **
(All Rights Reserved-Unauthorized Use Prohibited)

SLOPE STABILITY ANALYSIS SYSTEM

Modified Bishop, Simplified Janbu, or GLE Method of Slices.
(Includes Spencer & Morgenstern-Price Type Analysis)
Including Pier/Pile, Reinforcement, Soil Nail, Tieback,
Nonlinear Undrained Shear Strength, Curved Phi Envelope,
Anisotropic Soil, Fiber-Reinforced Soil, Boundary Loads, Water
Surfaces, Pseudo-Static & Newmark Earthquake, and Applied Forces.

Analysis Run Date: 11/7/2012
Time of Run: 10:54AM
Run By: Username
Input Data Filename: Z:\2010\10132-01 South Shores Church - Dana Point\Engineerin
g\2012_10\Alternate Design\dd'_2p.
Output Filename: Z:\2010\10132-01 South Shores Church - Dana Point\Engineerin
g\2012_10\Alternate Design\dd'_2p.OUT
Unit System: English
Plotted Output Filename: Z:\2010\10132-01 South Shores Church - Dana Point\Engineerin
g\2012_10\Alternate Design\dd'_2p.PLT
PROBLEM DESCRIPTION: D-D' / Design / Search Within Tsow /
Pseudostatic

BOUNDARY COORDINATES

26 Top Boundaries
46 Total Boundaries

Boundary No.	X-Left (ft)	Y-Left (ft)	X-Right (ft)	Y-Right (ft)	Soil Type Below Bnd
1	0.00	113.00	44.00	120.00	1
2	44.00	120.00	96.00	145.00	1
3	96.00	145.00	106.00	146.00	1
4	106.00	146.00	127.00	150.00	2
5	127.00	150.00	167.00	160.00	2
6	167.00	160.00	267.00	190.00	2
7	267.00	190.00	293.00	201.00	2
8	293.00	201.00	299.00	203.00	2
9	299.00	203.00	320.00	208.00	2
10	320.00	208.00	324.00	210.00	2
11	324.00	210.00	340.00	213.00	2
12	340.00	213.00	344.00	214.00	3
13	344.00	214.00	374.00	221.00	4
14	374.00	221.00	389.00	226.00	1
15	389.00	226.00	417.00	240.00	1
16	417.00	240.00	417.10	246.00	1
17	417.10	246.00	450.00	250.00	1
18	450.00	250.00	480.10	250.00	1
19	480.10	250.00	549.00	250.00	1
20	549.00	250.00	549.10	255.00	1
21	549.10	255.00	574.00	255.00	1
22	574.00	255.00	626.00	255.00	4
23	626.00	255.00	728.00	254.00	4
24	728.00	254.00	728.10	263.00	4
25	728.10	263.00	750.00	262.00	4
26	750.00	262.00	800.00	262.00	4
27	0.00	109.00	69.00	110.00	2
28	69.00	110.00	106.00	146.00	2
29	0.00	75.00	80.00	95.00	3
30	80.00	95.00	120.00	110.00	3
31	120.00	110.00	178.00	135.00	3
32	178.00	135.00	320.00	200.00	4
33	320.00	200.00	340.00	213.00	4
34	0.00	73.00	80.00	93.00	5
35	80.00	93.00	120.00	108.00	5
36	120.00	108.00	178.00	133.00	5
37	178.00	133.00	320.00	198.00	4
38	320.00	198.00	344.00	214.00	4
39	0.00	14.00	80.00	58.00	4
40	80.00	58.00	107.00	75.00	4

41	107.00	75.00	129.00	91.00	4
42	129.00	91.00	178.00	133.00	4
43	374.00	221.00	377.00	216.00	4
44	377.00	216.00	395.00	215.00	4
45	395.00	215.00	396.00	220.00	4
46	396.00	220.00	574.00	255.00	4

Default Y-Origin = 0.00(ft)
Default X-Plus Value = 0.00(ft)
Default Y-Plus Value = 0.00(ft)

ISOTROPIC SOIL PARAMETERS

5 Type(s) of Soil									
Soil No.	Total Unit Wt. (pcf)	Saturated Unit Wt. (pcf)	Cohesion (psf)	Friction Angle (deg)	Pore Pressure Param. (psf)	Pressure Constant (psf)	Piez. Surface		
1	130.0	130.0	200.0	29.0	0.00	0.0	0		
2	130.0	130.0	270.0	19.0	0.00	0.0	0		
3	130.0	130.0	270.0	19.0	0.00	0.0	0		
4	130.0	130.0	500.0	30.0	0.00	0.0	0		
5	130.0	130.0	270.0	19.0	0.00	0.0	0		

BOUNDARY LOAD(S)

2 Load(s) Specified				
Load No.	X-Left (ft)	X-Right (ft)	Intensity (psf)	Deflection (deg)
1	480.10	549.00	500.0	0.0
2	604.00	728.00	500.0	0.0

NOTE - Intensity Is Specified As A Uniformly Distributed

Force Acting On A Horizontally Projected Surface.

Specified Peak Ground Acceleration Coefficient (A) = 0.300(g)

Specified Horizontal Earthquake Coefficient (kh) = 0.150(g)

Specified Vertical Earthquake Coefficient (kv) = 0.000(g)

Specified Seismic Pore-Pressure Factor = 0.000

A Critical Failure Surface Searching Method, Using A Random

Technique For Generating Circular Surfaces, Has Been Specified.

1500 Trial Surfaces Have Been Generated.

100 Surface(s) Initiate(s) From Each Of 15 Points Equally Spaced

Along The Ground Surface Between X = 10.00(ft)

and X = 50.00(ft)

Each Surface Terminates Between X = 400.00(ft)

and X = 650.00(ft)

Unless Further Limitations Were Imposed, The Minimum Elevation

At Which A Surface Extends Is Y = 0.00(ft)

20.00(ft) Line Segments Define Each Trial Failure Surface.

Following Are Displayed The Ten Most Critical Of The Trial

Failure Surfaces Evaluated. They Are

Ordered - Most Critical First.

* * Safety Factors Are Calculated By The Modified Bishop Method * *

Total Number of Trial Surfaces Attempted = 1500

Number of Trial Surfaces With Valid FS = 1500

Statistical Data On All Valid FS Values:

FS Max = 2.471 FS Min = 1.403 FS Ave = 1.914

Standard Deviation = 0.297 Coefficient of Variation = 15.53 %

Failure Surface Specified By 25 Coordinate Points

Point No.	X-Surf (ft)	Y-Surf (ft)
1	10.000	114.591
2	29.954	113.238
3	49.941	112.523
4	69.941	112.446
5	89.933	113.009
6	109.897	114.209
7	129.813	116.046
8	149.659	118.519
9	169.417	121.624
10	189.065	125.358
11	208.584	129.718
12	227.954	134.699
13	247.155	140.296
14	266.167	146.504
15	284.971	153.315
16	303.549	160.723

17	321.880	168.721
18	339.946	177.300
19	357.730	186.452
20	375.212	196.167
21	392.374	206.436
22	409.200	217.247
23	425.673	228.590
24	441.774	240.453
25	453.901	250.000

Circle Center At X = 62.335 ; Y = 738.593 ; and Radius = 626.193

Factor of Safety

*** 1.403 ***

Individual data on the

Slice No.	Width (ft)	Weight (lbs)	Water		Tie		Earthquake		Surcharge (lbs)
			Top Force (lbs)	Bot Force (lbs)	Norm Force (lbs)	Tan Force (lbs)	Hor Force (lbs)	Ver Force (lbs)	
1	20.0	5872.4	0.0	0.0	0.0	0.0	880.9	0.0	0.0
2	14.0	10766.1	0.0	0.0	0.0	0.0	1614.9	0.0	0.0
3	5.9	6796.3	0.0	0.0	0.0	0.0	1019.4	0.0	0.0
4	20.0	39466.6	0.0	0.0	0.0	0.0	5920.0	0.0	0.0
5	1.6	4294.1	0.0	0.0	0.0	0.0	644.1	0.0	0.0
6	18.4	59510.9	0.0	0.0	0.0	0.0	8926.6	0.0	0.0
7	6.1	23936.5	0.0	0.0	0.0	0.0	3590.5	0.0	0.0
8	10.0	41373.8	0.0	0.0	0.0	0.0	6206.1	0.0	0.0
9	3.9	16354.2	0.0	0.0	0.0	0.0	2453.1	0.0	0.0
10	17.1	74200.4	0.0	0.0	0.0	0.0	11130.1	0.0	0.0
11	2.8	12591.2	0.0	0.0	0.0	0.0	1888.7	0.0	0.0
12	5.9	26995.8	0.0	0.0	0.0	0.0	4049.4	0.0	0.0
13	6.5	30381.1	0.0	0.0	0.0	0.0	4557.2	0.0	0.0
14	7.4	35250.7	0.0	0.0	0.0	0.0	5287.6	0.0	0.0
15	14.0	68867.2	0.0	0.0	0.0	0.0	10330.1	0.0	0.0
16	3.3	16685.4	0.0	0.0	0.0	0.0	2502.8	0.0	0.0
17	2.4	12230.8	0.0	0.0	0.0	0.0	1834.6	0.0	0.0
18	8.6	44156.2	0.0	0.0	0.0	0.0	6623.4	0.0	0.0
19	11.1	58477.9	0.0	0.0	0.0	0.0	8771.7	0.0	0.0
20	19.5	106597.3	0.0	0.0	0.0	0.0	15989.6	0.0	0.0
21	19.4	108710.7	0.0	0.0	0.0	0.0	16306.6	0.0	0.0
22	19.2	109001.9	0.0	0.0	0.0	0.0	16350.3	0.0	0.0
23	19.0	107510.8	0.0	0.0	0.0	0.0	16126.6	0.0	0.0
24	0.8	4680.1	0.0	0.0	0.0	0.0	702.0	0.0	0.0
25	18.0	102192.9	0.0	0.0	0.0	0.0	15328.9	0.0	0.0
26	8.0	46326.2	0.0	0.0	0.0	0.0	6948.9	0.0	0.0
27	6.0	34543.9	0.0	0.0	0.0	0.0	5181.6	0.0	0.0
28	4.5	25856.1	0.0	0.0	0.0	0.0	3878.4	0.0	0.0
29	16.5	89245.3	0.0	0.0	0.0	0.0	13386.8	0.0	0.0
30	1.9	9814.4	0.0	0.0	0.0	0.0	1472.2	0.0	0.0
31	2.1	11092.1	0.0	0.0	0.0	0.0	1663.8	0.0	0.0
32	15.9	78735.3	0.0	0.0	0.0	0.0	11810.3	0.0	0.0
33	0.1	248.7	0.0	0.0	0.0	0.0	37.3	0.0	0.0
34	4.0	18274.2	0.0	0.0	0.0	0.0	2741.1	0.0	0.0
35	13.7	58333.3	0.0	0.0	0.0	0.0	8750.0	0.0	0.0
36	16.3	59496.3	0.0	0.0	0.0	0.0	8924.4	0.0	0.0
37	1.2	3996.1	0.0	0.0	0.0	0.0	599.4	0.0	0.0
38	1.8	5812.3	0.0	0.0	0.0	0.0	871.8	0.0	0.0
39	12.0	36149.8	0.0	0.0	0.0	0.0	5422.5	0.0	0.0
40	3.4	9395.0	0.0	0.0	0.0	0.0	1409.2	0.0	0.0
41	2.6	7190.1	0.0	0.0	0.0	0.0	1078.5	0.0	0.0
42	1.0	2704.8	0.0	0.0	0.0	0.0	405.7	0.0	0.0
43	13.2	33967.6	0.0	0.0	0.0	0.0	5095.1	0.0	0.0
44	7.8	18370.4	0.0	0.0	0.0	0.0	2755.6	0.0	0.0
45	0.1	264.5	0.0	0.0	0.0	0.0	39.7	0.0	0.0
46	3.0	8681.9	0.0	0.0	0.0	0.0	1302.3	0.0	0.0
47	5.6	14590.9	0.0	0.0	0.0	0.0	2188.6	0.0	0.0
48	16.1	28257.3	0.0	0.0	0.0	0.0	4238.6	0.0	0.0
49	8.2	6211.6	0.0	0.0	0.0	0.0	931.7	0.0	0.0
50	3.9	778.6	0.0	0.0	0.0	0.0	116.8	0.0	0.0

Failure Surface Specified By 25 Coordinate Points

Point No.	X-Surf (ft)	Y-Surf (ft)
-----------	-------------	-------------

1	10.000	114.591
2	29.961	113.345
3	49.952	112.747
4	69.952	112.797
5	89.940	113.495
6	109.895	114.840
7	129.795	116.832
8	149.621	119.467
9	169.351	122.744
10	188.964	126.659
11	208.440	131.207
12	227.758	136.384
13	246.899	142.184
14	265.841	148.602
15	284.565	155.630
16	303.052	163.261
17	321.282	171.488
18	339.236	180.301
19	356.894	189.691
20	374.239	199.649
21	391.252	210.163
22	407.915	221.224
23	424.211	232.819
24	440.123	244.936
25	445.702	249.478

Circle Center At X = 58.412 ; Y = 729.689 ; and Radius = 617.000

Factor of Safety

*** 1.405 ***

Failure Surface Specified By 25 Coordinate Points

Point No.	X-Surf (ft)	Y-Surf (ft)
1	15.714	115.500
2	35.687	114.462
3	55.683	114.055
4	75.682	114.279
5	95.664	115.134
6	115.608	116.619
7	135.496	118.733
8	155.308	121.474
9	175.023	124.839
10	194.622	128.824
11	214.085	133.426
12	233.393	138.639
13	252.528	144.460
14	271.469	150.881
15	290.198	157.897
16	308.696	165.501
17	326.945	173.685
18	344.927	182.440
19	362.623	191.759
20	380.016	201.632
21	397.090	212.048
22	413.826	222.999
23	430.208	234.472
24	446.219	246.456
25	450.655	250.000

Circle Center At X = 58.584 ; Y = 747.668 ; and Radius = 633.620

Factor of Safety

*** 1.405 ***

Failure Surface Specified By 25 Coordinate Points

Point No.	X-Surf (ft)	Y-Surf (ft)
1	15.714	115.500
2	35.708	114.992
3	55.708	115.066
4	75.697	115.721
5	95.659	116.956
6	115.576	118.772
7	135.433	121.165
8	155.211	124.134

9	174.895	127.677
10	194.467	131.791
11	213.912	136.471
12	233.212	141.715
13	252.352	147.517
14	271.315	153.874
15	290.085	160.778
16	308.647	168.226
17	326.984	176.209
18	345.082	184.722
19	362.925	193.758
20	380.497	203.308
21	397.785	213.365
22	414.773	223.920
23	431.447	234.964
24	447.792	246.489
25	452.477	250.000

Circle Center At X = 43.174 ; Y = 803.041 ; and Radius = 688.089
 Factor of Safety
 *** 1.406 ***

Failure Surface Specified By 25 Coordinate Points

Point No.	X-Surf (ft)	Y-Surf (ft)
1	10.000	114.591
2	29.913	112.724
3	49.878	111.540
4	69.871	111.042
5	89.871	111.230
6	109.851	112.103
7	129.791	113.660
8	149.665	115.900
9	169.451	118.821
10	189.124	122.417
11	208.664	126.686
12	228.045	131.623
13	247.245	137.221
14	266.243	143.474
15	285.015	150.374
16	303.539	157.914
17	321.794	166.085
18	339.758	174.876
19	357.410	184.278
20	374.729	194.280
21	391.696	204.870
22	408.289	216.035
23	424.490	227.763
24	440.279	240.039
25	452.223	250.000

Circle Center At X = 74.403 ; Y = 694.333 ; and Radius = 583.308
 Factor of Safety
 *** 1.407 ***

Failure Surface Specified By 25 Coordinate Points

Point No.	X-Surf (ft)	Y-Surf (ft)
1	24.286	116.864
2	44.285	116.673
3	64.282	117.014
4	84.263	117.888
5	104.213	119.294
6	124.119	121.231
7	143.967	123.698
8	163.741	126.691
9	183.429	130.211
10	203.016	134.254
11	222.489	138.816
12	241.833	143.896
13	261.035	149.489
14	280.081	155.592
15	298.958	162.200
16	317.652	169.308

17	336.151	176.911
18	354.440	185.005
19	372.507	193.582
20	390.340	202.638
21	407.925	212.165
22	425.249	222.158
23	442.302	232.608
24	459.070	243.509
25	468.497	250.000

Circle Center At X = 41.455 ; Y = 867.571 ; and Radius = 750.903
 Factor of Safety
 *** 1.411 ***

Failure Surface Specified By 24 Coordinate Points

Point No.	X-Surf (ft)	Y-Surf (ft)
1	15.714	115.500
2	35.661	114.048
3	55.647	113.285
4	75.647	113.214
5	95.637	113.833
6	115.594	115.142
7	135.494	117.139
8	155.314	119.823
9	175.028	123.189
10	194.615	127.234
11	214.050	131.953
12	233.311	137.341
13	252.374	143.391
14	271.217	150.095
15	289.817	157.446
16	308.152	165.435
17	326.200	174.052
18	343.940	183.288
19	361.350	193.131
20	378.411	203.569
21	395.100	214.590
22	411.399	226.181
23	427.288	238.327
24	440.033	248.788

Circle Center At X = 67.755 ; Y = 691.877 ; and Radius = 578.721
 Factor of Safety
 *** 1.411 ***

Failure Surface Specified By 26 Coordinate Points

Point No.	X-Surf (ft)	Y-Surf (ft)
1	10.000	114.591
2	29.990	113.965
3	49.990	113.861
4	69.986	114.278
5	89.964	115.216
6	109.910	116.675
7	129.812	118.653
8	149.656	121.149
9	169.428	124.162
10	189.114	127.688
11	208.702	131.727
12	228.178	136.275
13	247.529	141.329
14	266.742	146.886
15	285.803	152.941
16	304.700	159.492
17	323.420	166.532
18	341.950	174.059
19	360.277	182.065
20	378.389	190.547
21	396.275	199.498
22	413.920	208.912
23	431.315	218.783
24	448.446	229.103
25	465.303	239.867

26 480.295 250.000
 Circle Center At X = 44.012 ; Y = 880.867 ; and Radius = 767.031
 Factor of Safety
 *** 1.412 ***

Failure Surface Specified By 26 Coordinate Points

Point No.	X-Surf (ft)	Y-Surf (ft)
1	12.857	115.045
2	32.787	113.374
3	52.759	112.317
4	72.754	111.877
5	92.754	112.054
6	112.738	112.847
7	132.688	114.256
8	152.586	116.280
9	172.411	118.916
10	192.146	122.162
11	211.771	126.016
12	231.268	130.472
13	250.619	135.528
14	269.804	141.178
15	288.806	147.417
16	307.607	154.239
17	326.188	161.637
18	344.532	169.605
19	362.622	178.134
20	380.441	187.218
21	397.970	196.846
22	415.195	207.010
23	432.098	217.701
24	448.663	228.908
25	464.875	240.620
26	477.048	250.000

Circle Center At X = 77.058 ; Y = 760.016 ; and Radius = 648.158
 Factor of Safety
 *** 1.414 ***

Failure Surface Specified By 25 Coordinate Points

Point No.	X-Surf (ft)	Y-Surf (ft)
1	18.571	115.955
2	38.464	113.886
3	58.420	112.550
4	78.410	111.947
5	98.410	112.079
6	118.391	112.946
7	138.327	114.545
8	158.191	116.876
9	177.956	119.935
10	197.595	123.717
11	217.082	128.218
12	236.390	133.432
13	255.494	139.352
14	274.368	145.969
15	292.986	153.274
16	311.323	161.259
17	329.354	169.911
18	347.056	179.220
19	364.403	189.173
20	381.374	199.756
21	397.944	210.955
22	414.092	222.755
23	429.796	235.141
24	445.034	248.094
25	464.674	249.596

Circle Center At X = 84.817 ; Y = 656.402 ; and Radius = 544.493
 Factor of Safety
 *** 1.416 ***

E-E' / Design / Search Within Tsow /

z:\2010\10132-01 south shores church - dana point\engineering\2012_10\alternate design\ee'_1.pl2 Run By: Username 10/23/2012 02:36PM

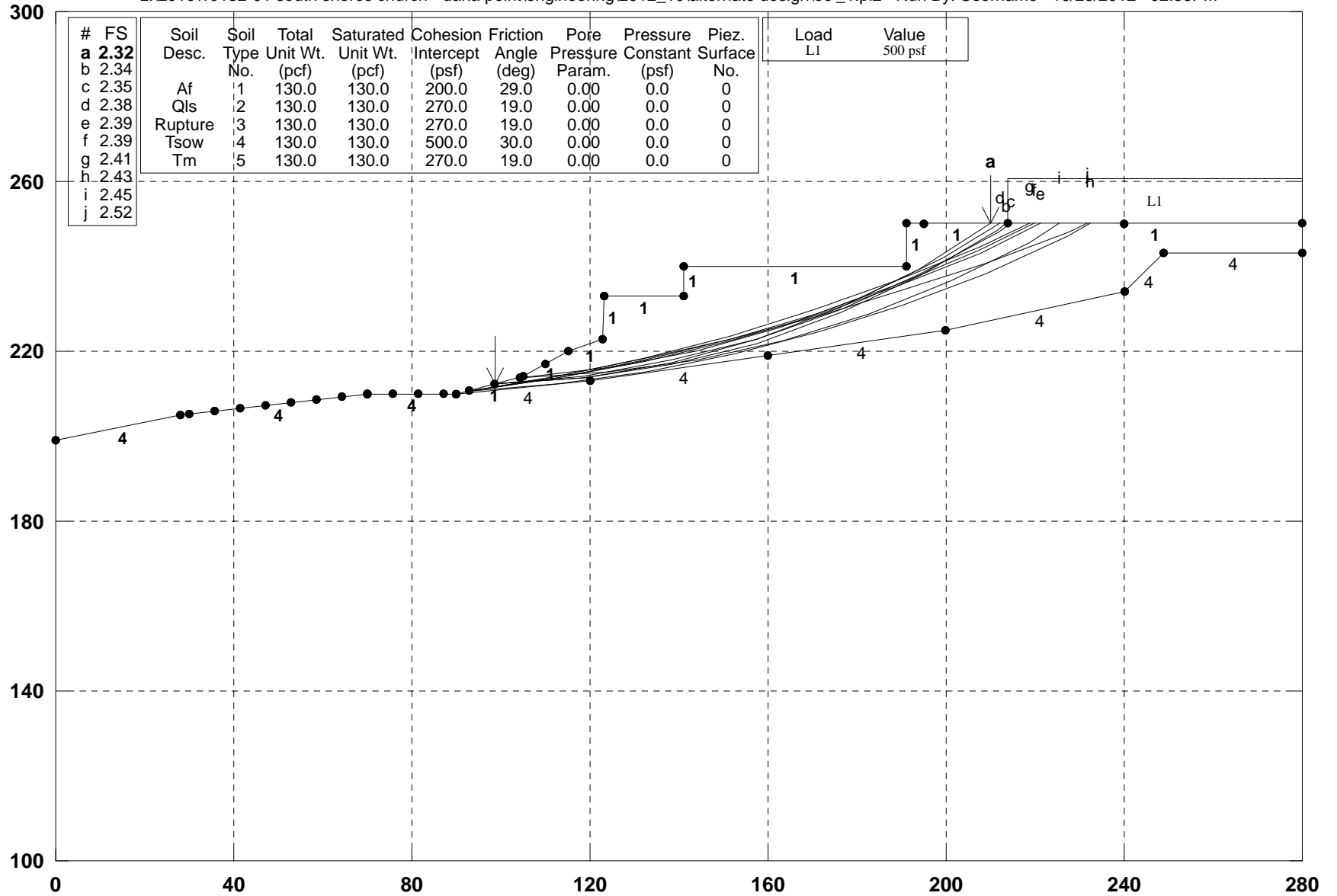

GSTABL7 v.2 FSmin=2.32

Safety Factors Are Calculated By The Modified Bishop Method

*** GSTABL7 ***

** GSTABL7 by Dr. Garry H. Gregory, Ph.D., P.E., D.GE **
 ** Original Version 1.0, January 1996; Current Ver. 2.005.2, Jan. 2011 **
 (All Rights Reserved-Unauthorizd Use Prohibited)

SLOPE STABILITY ANALYSIS SYSTEM

Modified Bishop, Simplified Janbu, or GLE Method of Slices.
 (Includes Spencer & Morgenstern-Price Type Analysis)
 Including Pier/Pile, Reinforcement, Soil Nail, Tieback,
 Nonlinear Undrained Shear Strength, Curved Phi Envelope,
 Anisotropic Soil, Fiber-Reinforced Soil, Boundary Loads, Water
 Surfaces, Pseudo-Static & Newmark Earthquake, and Applied Forces.

 Analysis Run Date: 10/23/2012
 Time of Run: 02:36PM
 Run By: Username
 Input Data Filename: Z:\2010\10132-01 South Shores Church - Dana Point\Engineerin
 g\2012_10\Alternate Design\ee'_1.
 Output Filename: Z:\2010\10132-01 South Shores Church - Dana Point\Engineerin
 g\2012_10\Alternate Design\ee'_1.OUT
 Unit System: English
 Plotted Output Filename: Z:\2010\10132-01 South Shores Church - Dana Point\Engineerin
 g\2012_10\Alternate Design\ee'_1.PLT

PROBLEM DESCRIPTION: E-E' / Design / Search Within Tsow /
 BOUNDARY COORDINATES

Boundary No.	X-Left (ft)	Y-Left (ft)	X-Right (ft)	Y-Right (ft)	Soil Type Below Bnd
13 Top Boundaries					
19 Total Boundaries					
1	0.00	199.00	28.00	205.00	4
2	28.00	205.00	70.00	210.00	4
3	70.00	210.00	90.00	210.00	4
4	90.00	210.00	105.00	214.00	1
5	105.00	214.00	115.00	220.00	1
6	115.00	220.00	123.00	223.00	1
7	123.00	223.00	123.10	233.00	1
8	123.10	233.00	141.00	233.00	1
9	141.00	233.00	141.10	240.00	1
10	141.10	240.00	191.00	240.00	1
11	191.00	240.00	191.10	250.00	1
12	191.10	250.00	214.00	250.00	1
13	214.00	250.00	280.00	250.00	1
14	90.00	210.00	120.00	213.00	4
15	120.00	213.00	160.00	219.00	4
16	160.00	219.00	200.00	225.00	4
17	200.00	225.00	240.00	234.00	4
18	240.00	234.00	249.00	243.00	4
19	249.00	243.00	280.00	243.00	4

User Specified Y-Origin = 100.00(ft)
 Default X-Plus Value = 0.00(ft)
 Default Y-Plus Value = 0.00(ft)

ISOTROPIC SOIL PARAMETERS

Soil Type	Total Unit Wt. (pcf)	Saturated Unit Wt. (pcf)	Cohesion (psf)	Friction Angle (deg)	Pore Pressure Param. (psf)	Pressure Constant	Piez. Surface
5 Type(s) of Soil							
1	130.0	130.0	200.0	29.0	0.00	0.0	0
2	130.0	130.0	270.0	19.0	0.00	0.0	0
3	130.0	130.0	270.0	19.0	0.00	0.0	0
4	130.0	130.0	500.0	30.0	0.00	0.0	0
5	130.0	130.0	270.0	19.0	0.00	0.0	0

BOUNDARY LOAD(S)

Load No.	X-Left (ft)	X-Right (ft)	Intensity (psf)	Deflection (deg)
1 Load(s) Specified				
1	214.00	280.00	500.0	0.0

NOTE - Intensity Is Specified As A Uniformly Distributed Force Acting On A Horizontally Projected Surface.
 A Critical Failure Surface Searching Method, Using A Random Technique For Generating Circular Surfaces, Has Been Specified.

1500 Trial Surfaces Have Been Generated.
 100 Surface(s) Initiate(s) From Each Of 15 Points Equally Spaced
 Along The Ground Surface Between X = 30.00(ft)
 and X = 110.00(ft)
 Each Surface Terminates Between X = 195.00(ft)
 and X = 240.00(ft)

Unless Further Limitations Were Imposed, The Minimum Elevation At Which A Surface Extends Is Y = 0.00(ft)
 20.00(ft) Line Segments Define Each Trial Failure Surface.
 Following Are Displayed The Ten Most Critical Of The Trial Failure Surfaces Evaluated. They Are

Ordered - Most Critical First.
 * * Safety Factors Are Calculated By The Modified Bishop Method * *
 Total Number of Trial Surfaces Attempted = 1500
 Number of Trial Surfaces With Valid FS = 1500
 Statistical Data on All Valid FS Values:
 FS Max = 5.647 FS Min = 2.318 FS Ave = 3.556
 Standard Deviation = 0.594 Coefficient of Variation = 16.72 %
 Failure Surface Specified By 7 Coordinate Points

Point No.	X-Surf (ft)	Y-Surf (ft)
1	98.571	212.286
2	118.512	213.824
3	138.200	217.345
4	157.438	222.812
5	176.035	220.172
6	193.804	239.351
7	210.174	250.000

Circle Center At X = 93.164 ; Y = 412.391 ; and Radius = 200.179
 Factor of Safety

*** 2.318 ***

Slice No.	Width (ft)	Weight (lbs)	Water Force (lbs)	Water Force (lbs)	Tie Norm (lbs)	Tie Force (lbs)	Earthquake Force (lbs)	Surcharge Ver (lbs)	Load (lbs)
Individual data on the 14 slices									
1	6.4	509.1	0.0	0.0	0.0	0.0	0.0	0.0	0.0
2	10.0	4982.4	0.0	0.0	0.0	0.0	0.0	0.0	0.0
3	3.5	3182.4	0.0	0.0	0.0	0.0	0.0	0.0	0.0
4	4.5	4628.4	0.0	0.0	0.0	0.0	0.0	0.0	0.0
5	0.1	173.7	0.0	0.0	0.0	0.0	0.0	0.0	0.0
6	15.1	33381.6	0.0	0.0	0.0	0.0	0.0	0.0	0.0
7	2.8	5553.9	0.0	0.0	0.0	0.0	0.0	0.0	0.0
8	0.1	238.5	0.0	0.0	0.0	0.0	0.0	0.0	0.0
9	16.3	41437.4	0.0	0.0	0.0	0.0	0.0	0.0	0.0
10	18.6	32656.4	0.0	0.0	0.0	0.0	0.0	0.0	0.0
11	15.0	11600.8	0.0	0.0	0.0	0.0	0.0	0.0	0.0
12	0.1	91.9	0.0	0.0	0.0	0.0	0.0	0.0	0.0
13	2.7	3988.9	0.0	0.0	0.0	0.0	0.0	0.0	0.0
14	16.4	11331.3	0.0	0.0	0.0	0.0	0.0	0.0	0.0

Failure Surface Specified By 8 Coordinate Points

Point No.	X-Surf (ft)	Y-Surf (ft)
1	98.571	212.286
2	118.530	213.577
3	138.266	216.816
4	157.590	221.971
5	176.317	228.993
6	194.266	237.814
7	211.266	248.350
8	213.423	250.000

Circle Center At X = 95.596 ; Y = 415.085 ; and Radius = 202.821
 Factor of Safety

*** 2.340 ***

Failure Surface Specified By 8 Coordinate Points

Point No.	X-Surf (ft)	Y-Surf (ft)
1	98.571	212.286
2	118.480	214.198
3	138.157	217.777

4 157.463 222.999
 5 176.262 229.826
 6 194.420 238.210
 7 211.809 248.091
 8 214.593 250.000
 Circle Center At X = 86.140 ; Y = 447.847 ; and Radius = 235.889
 Factor of Safety
 *** 2.353 ***

Failure Surface Specified By 7 Coordinate Points

Point No.	X-Surf (ft)	Y-Surf (ft)
1	104.286	213.810
2	124.157	216.071
3	143.754	220.070
4	162.923	225.775
5	181.516	233.142
6	199.391	242.114
7	212.163	250.000

Circle Center At X = 88.526 ; Y = 440.696 ; and Radius = 227.433
 Factor of Safety
 *** 2.382 ***

Failure Surface Specified By 8 Coordinate Points

Point No.	X-Surf (ft)	Y-Surf (ft)
1	92.857	210.762
2	112.652	213.622
3	132.267	217.525
4	151.649	222.460
5	170.742	228.414
6	189.493	235.369
7	207.851	243.307
8	221.325	250.000

Circle Center At X = 49.268 ; Y = 583.398 ; and Radius = 375.177
 Factor of Safety
 *** 2.391 ***

Failure Surface Specified By 8 Coordinate Points

Point No.	X-Surf (ft)	Y-Surf (ft)
1	92.857	210.762
2	112.626	213.796
3	132.212	217.845
4	151.562	222.899
5	170.627	228.945
6	189.354	235.967
7	207.693	243.945
8	219.856	250.000

Circle Center At X = 44.669 ; Y = 591.869 ; and Radius = 384.141
 Factor of Safety
 *** 2.393 ***

Failure Surface Specified By 8 Coordinate Points

Point No.	X-Surf (ft)	Y-Surf (ft)
1	92.857	210.762
2	112.572	214.126
3	132.107	218.414
4	151.418	223.618
5	170.463	229.724
6	189.200	236.720
7	207.586	244.590
8	218.742	250.000

Circle Center At X = 32.175 ; Y = 626.995 ; and Radius = 420.634
 Factor of Safety
 *** 2.410 ***

Failure Surface Specified By 9 Coordinate Points

Point No.	X-Surf (ft)	Y-Surf (ft)
1	92.857	210.762
2	112.792	212.371
3	132.592	215.193
4	152.183	219.216

5 171.493 224.426
 6 190.449 230.804
 7 208.981 238.325
 8 227.019 246.962
 9 232.482 250.000
 Circle Center At X = 76.452 ; Y = 538.272 ; and Radius = 327.920
 Factor of Safety
 *** 2.433 ***

Failure Surface Specified By 8 Coordinate Points

Point No.	X-Surf (ft)	Y-Surf (ft)
1	104.286	213.810
2	124.246	215.074
3	144.031	218.000
4	163.502	222.566
5	182.525	228.741
6	200.967	236.481
7	218.698	245.733
8	225.438	250.000

Circle Center At X = 99.519 ; Y = 450.649 ; and Radius = 236.887
 Factor of Safety
 *** 2.447 ***

Failure Surface Specified By 9 Coordinate Points

Point No.	X-Surf (ft)	Y-Surf (ft)
1	92.857	210.762
2	112.566	214.163
3	132.151	218.218
4	151.589	222.922
5	170.861	228.270
6	189.944	234.256
7	208.818	240.874
8	227.461	248.116
9	231.871	250.000

Circle Center At X = 0.505 ; Y = 804.750 ; and Radius = 601.125
 Factor of Safety
 *** 2.523 ***

**** END OF GSTABL7 OUTPUT ****

E-E' / Design / Search Within Tsow / Pseudostatic

z:\2010\10132-01 south shores church - dana point\engineering\2012_10\alternate design\ee'_1p.pl2 Run By: Username 10/23/2012 02:38PM

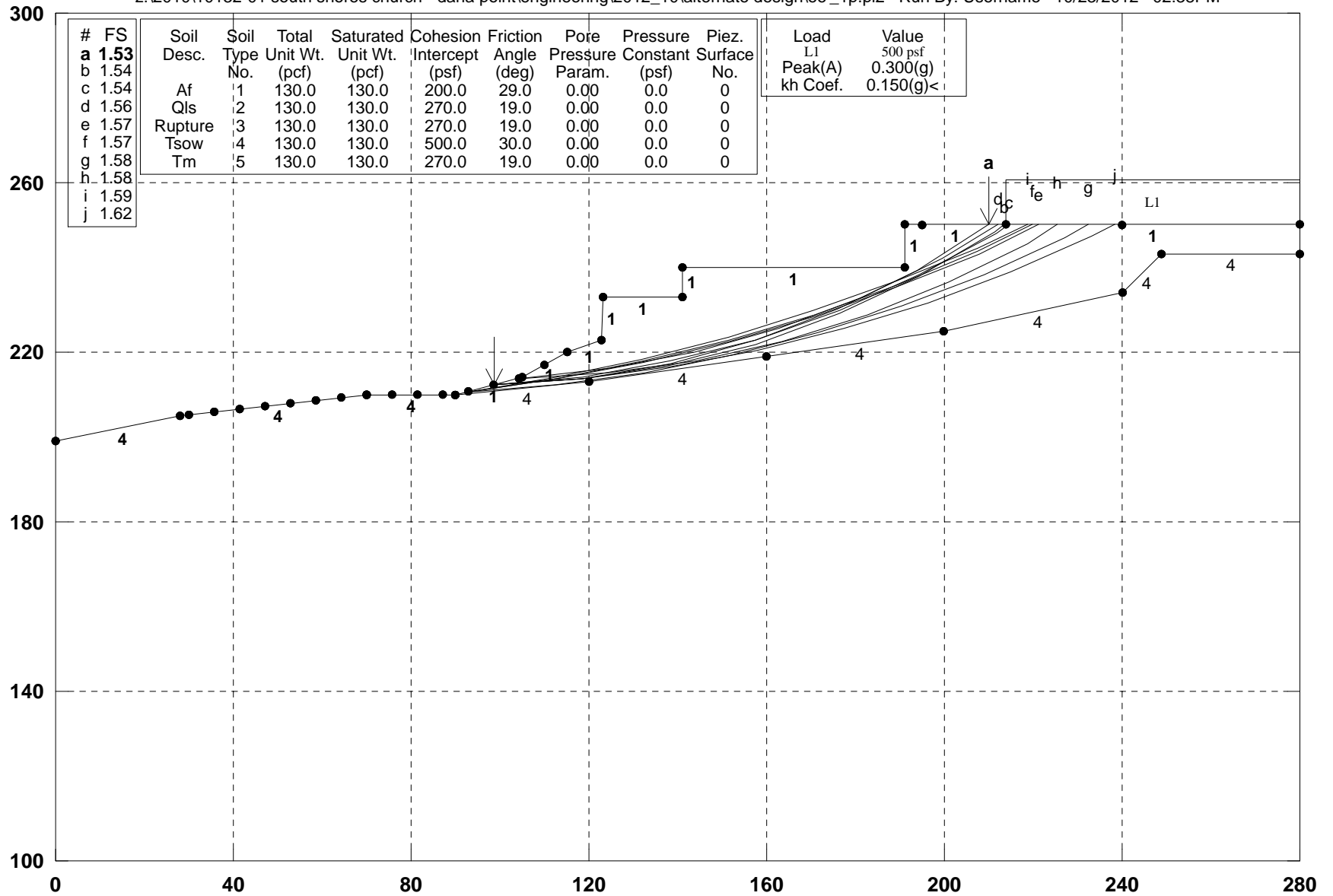

GSTABL7 v.2 FSmin=1.53

Safety Factors Are Calculated By The Modified Bishop Method

*** GSTABL7 ***

** GSTABL7 by Dr. Garry H. Gregory, Ph.D.,P.E.,D.GE **
** Original Version 1.0, January 1996; Current Ver. 2.005.2, Jan. 2011 **
(All Rights Reserved-Unauthorizd Use Prohibited)

SLOPE STABILITY ANALYSIS SYSTEM

Modified Bishop, Simplified Janbu, or GLE Method of Slices.
(Includes Spencer & Morgenstern-Price Type Analysis)
Including Pier/Pile, Reinforcement, Soil Nail, Tieback,
Nonlinear Undrained Shear Strength, Curved Phi Envelope,
Anisotropic Soil, Fiber-Reinforced Soil, Boundary Loads, Water
Surfaces, Pseudo-Static & Newmark Earthquake, and Applied Forces.

Analysis Run Date: 10/23/2012
Time of Run: 02:38PM
Run By: Username
Input Data Filename: Z:\2010\10132-01 South Shores Church - Dana Point\Engineerin
g\2012_10\Alternate Design\ee'_lp.
Output Filename: Z:\2010\10132-01 South Shores Church - Dana Point\Engineerin
g\2012_10\Alternate Design\ee'_lp.OUT
Unit System: English
Plotted Output Filename: Z:\2010\10132-01 South Shores Church - Dana Point\Engineerin
g\2012_10\Alternate Design\ee'_lp.PLT
PROBLEM DESCRIPTION: E-E' / Design / Search Within Tsow /
Pseudostatic

BOUNDARY COORDINATES

Table with 6 columns: No., X-Left (ft), Y-Left (ft), X-Right (ft), Y-Right (ft), Soil Type Below Bnd. Rows 1-19.

User Specified Y-Origin = 100.00(ft)
Default X-Plus Value = 0.00(ft)
Default Y-Plus Value = 0.00(ft)

ISOTROPIC SOIL PARAMETERS

Table with 7 columns: No., Total Unit Wt. (pcf), Saturated Unit Wt. (pcf), Cohesion (psf), Friction Angle (deg), Pore Pressure Param. (psf), Piez. Surface No. Rows 1-5.

BOUNDARY LOAD(S)

Table with 5 columns: No., X-Left (ft), X-Right (ft), Intensity (psf), Deflection (deg). Row 1.

NOTE - Intensity Is Specified As A Uniformly Distributed Force Acting On A Horizontally Projected Surface.
Specified Peak Ground Acceleration Coefficient (A) = 0.300(g)

Specified Horizontal Earthquake Coefficient (kh) = 0.150(g)
Specified Vertical Earthquake Coefficient (kv) = 0.000(g)
Specified Seismic Pore-Pressure Factor = 0.000
A Critical Failure Surface Searching Method, Using A Random Technique For Generating Circular Surfaces, Has Been Specified.
1500 Trial Surfaces Have Been Generated.
100 Surface(s) Initiate(s) From Each Of 15 Points Equally Spaced Along The Ground Surface Between X = 30.00(ft) and X = 110.00(ft)
Each Surface Terminates Between X = 195.00(ft) and X = 240.00(ft)

Unless Further Limitations Were Imposed, The Minimum Elevation At Which A Surface Extends Is Y = 0.00(ft)
20.00(ft) Line Segments Define Each Trial Failure Surface.
Following Are Displayed The Ten Most Critical Of The Trial Failure Surfaces Evaluated. They Are Ordered - Most Critical First.

** Safety Factors Are Calculated By The Modified Bishop Method **
Total Number of Trial Surfaces Attempted = 1500
Number of Trial Surfaces With Valid FS = 1500
Statistical Data On All Valid FS Values:
FS Max = 3.591 FS Min = 1.532 FS Ave = 2.335
Standard Deviation = 0.380 Coefficient of Variation = 16.26 %
Failure Surface Specified By 7 Coordinate Points

Table with 3 columns: Point No., X-Surf (ft), Y-Surf (ft). Rows 1-7.

Circle Center At X = 93.164 ; Y = 412.391 ; and Radius = 200.179
Factor of Safety *** 1.532 ***

Table with 11 columns: Slice No., Width (ft), Weight (lbs), Top Force (lbs), Bot Force (lbs), Tie Norm (lbs), Tie Tan (lbs), Earthquake Hor Force (lbs), Ver Force (lbs), Surcharge Load (lbs). Rows 1-14.

Failure Surface Specified By 8 Coordinate Points

Table with 3 columns: Point No., X-Surf (ft), Y-Surf (ft). Rows 1-8.

Circle Center At X = 95.596 ; Y = 415.085 ; and Radius = 202.821
Factor of Safety *** 1.537 ***

Failure Surface Specified By 8 Coordinate Points

Point No.	X-Surf (ft)	Y-Surf (ft)
1	98.571	212.286
2	118.480	214.198
3	138.157	217.777
4	157.463	222.999
5	176.262	229.826
6	194.420	238.210
7	211.809	248.091
8	214.593	250.000

Circle Center At X = 86.140 ; Y = 447.847 ; and Radius = 235.889
Factor of Safety
*** 1.543 ***

Failure Surface Specified By 7 Coordinate Points

Point No.	X-Surf (ft)	Y-Surf (ft)
1	104.286	213.810
2	124.157	216.071
3	143.754	220.070
4	162.923	225.775
5	181.516	233.142
6	199.391	242.114
7	212.163	250.000

Circle Center At X = 88.526 ; Y = 440.696 ; and Radius = 227.433
Factor of Safety
*** 1.560 ***

Failure Surface Specified By 8 Coordinate Points

Point No.	X-Surf (ft)	Y-Surf (ft)
1	92.857	210.762
2	112.652	213.622
3	132.267	217.525
4	151.649	222.460
5	170.742	228.414
6	189.493	235.369
7	207.851	243.307
8	221.325	250.000

Circle Center At X = 49.268 ; Y = 583.398 ; and Radius = 375.177
Factor of Safety
*** 1.571 ***

Failure Surface Specified By 8 Coordinate Points

Point No.	X-Surf (ft)	Y-Surf (ft)
1	92.857	210.762
2	112.626	213.796
3	132.212	217.845
4	151.562	222.899
5	170.627	228.945
6	189.354	235.967
7	207.693	243.945
8	219.856	250.000

Circle Center At X = 44.669 ; Y = 591.869 ; and Radius = 384.141
Factor of Safety
*** 1.574 ***

Failure Surface Specified By 9 Coordinate Points

Point No.	X-Surf (ft)	Y-Surf (ft)
1	92.857	210.762
2	112.792	212.371
3	132.592	215.193
4	152.183	219.216
5	171.493	224.426
6	190.449	230.804
7	208.981	238.325
8	227.019	246.962
9	232.482	250.000

Circle Center At X = 76.452 ; Y = 538.272 ; and Radius = 327.920
Factor of Safety
*** 1.577 ***

Failure Surface Specified By 8 Coordinate Points

Point No.	X-Surf (ft)	Y-Surf (ft)
1	104.286	213.810
2	124.246	215.074
3	144.031	218.000
4	163.502	222.566
5	182.525	228.741
6	200.967	236.481
7	218.698	245.733
8	225.438	250.000

Circle Center At X = 99.519 ; Y = 450.649 ; and Radius = 236.887
Factor of Safety
*** 1.583 ***

Failure Surface Specified By 8 Coordinate Points

Point No.	X-Surf (ft)	Y-Surf (ft)
1	92.857	210.762
2	112.572	214.126
3	132.107	218.414
4	151.418	223.618
5	170.463	229.724
6	189.200	236.720
7	207.586	244.590
8	218.742	250.000

Circle Center At X = 32.175 ; Y = 626.995 ; and Radius = 420.634
Factor of Safety
*** 1.586 ***

Failure Surface Specified By 9 Coordinate Points

Point No.	X-Surf (ft)	Y-Surf (ft)
1	98.571	212.286
2	118.510	213.851
3	138.323	216.580
4	157.942	220.465
5	177.300	225.492
6	196.330	231.644
7	214.968	238.899
8	233.149	247.233
9	238.357	250.000

Circle Center At X = 81.835 ; Y = 553.334 ; and Radius = 341.459
Factor of Safety
*** 1.622 ***

**** END OF GSTABL7 OUTPUT ****

F-F' / Alternate Design / Search Along Clay

z:\2010\10132-01 south shores church - dana point\engineering\2013_05\alternate design\ff_1.pl2 Run By: Username 5/8/2013 05:07PM

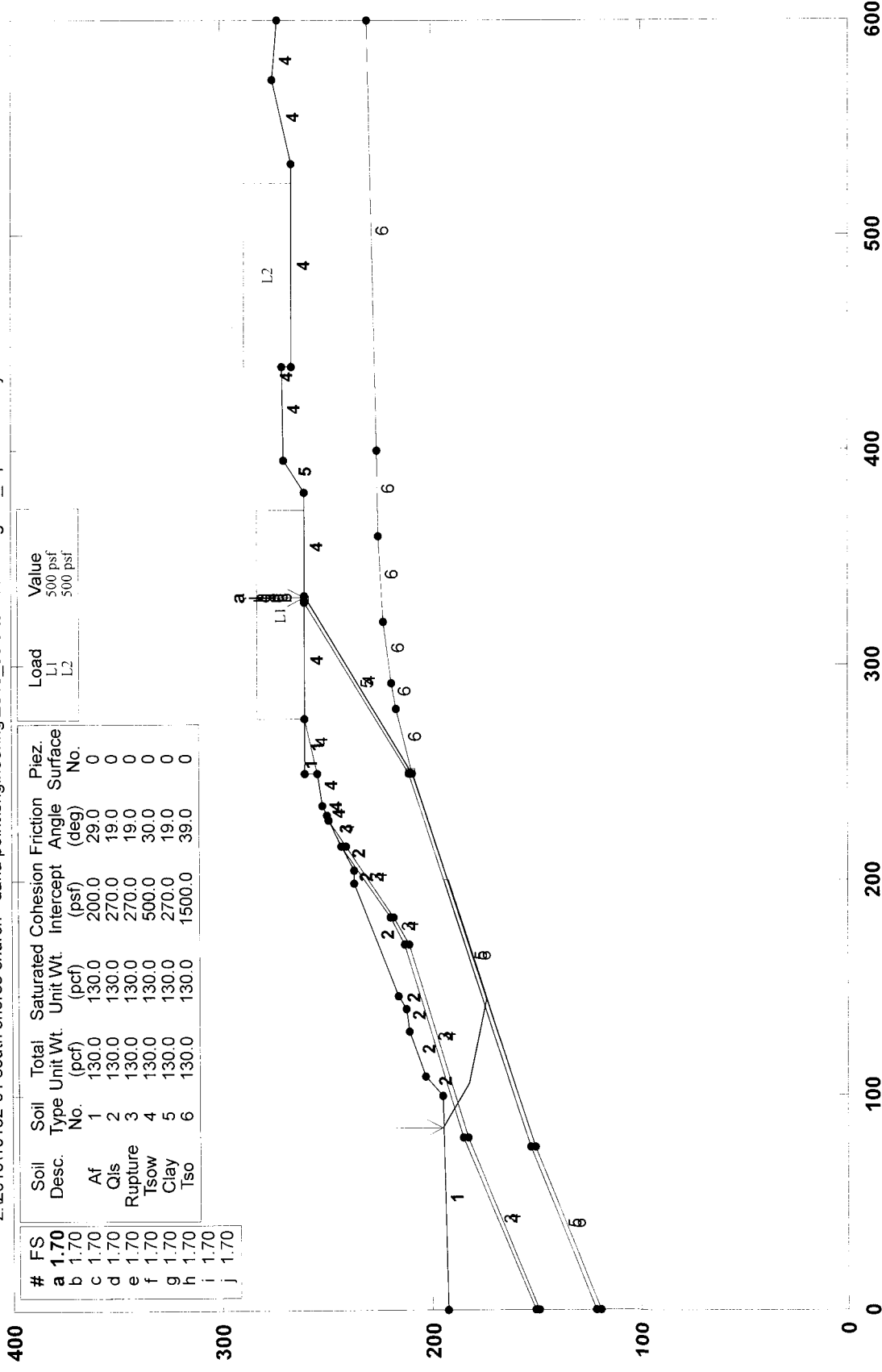

#	FS	Soil Desc.	Soil Type No.	Total Unit Wt. (pcf)	Saturated Unit Wt. (pcf)	Cohesion Intercept (psf)	Friction Angle (deg)	Piez. Surface No.
a	1.70	Af	1	130.0	130.0	200.0	29.0	0
b	1.70	Q/s	2	130.0	130.0	270.0	19.0	0
c	1.70	Rupture	3	130.0	130.0	270.0	19.0	0
d	1.70	Tsow	4	130.0	130.0	500.0	30.0	0
e	1.70	Clay	5	130.0	130.0	270.0	19.0	0
f	1.70	Tso	6	130.0	130.0	1500.0	39.0	0

GSTABL7 v.2 FSmin=1.70

Safety Factors Are Calculated By The Simplified Janbu Method for the case of c & phi both > 0

*** GSTABL7 ***

** GSTABL7 by Dr. Garry H. Gregory, Ph.D., P.E., D.GE **
 ** Original Version 1.0, January 1996; Current Ver. 2.005.2, Jan. 2011 **
 (All Rights Reserved-Unauthorized Use Prohibited)

SLOPE STABILITY ANALYSIS SYSTEM

Modified Bishop, Simplified Janbu, or GLE Method of Slices.
 (Includes Spencer & Morgenstern-Price Type Analysis)
 Including Pier/Pile, Reinforcement, Soil Nail, Tieback,
 Nonlinear Undrained Shear Strength, Curved Phi Envelope,
 Anisotropic Soil, Fiber-Reinforced Soil, Boundary Loads, Water
 Surfaces, Pseudo-Static & Newmark Earthquake, and Applied Forces.

Analysis Run Date: 5/8/2013
 Time of Run: 05:07PM
 Run By: Username
 Input Data Filename: Z:\2010\10132-01 South Shores Church - Dana Point\Engineerin
 g\2013 05\Alternate Design\ff'_1.
 Output Filename: Z:\2010\10132-01 South Shores Church - Dana Point\Engineerin
 g\2013 05\Alternate Design\ff'_1.OUT
 Unit System: English
 Plotted Output Filename: Z:\2010\10132-01 South Shores Church - Dana Point\Engineerin
 g\2013 05\Alternate Design\ff'_1.PLT
 PROBLEM DESCRIPTION: F-F' / Alternate Design / Search Along
 Clay

BOUNDARY COORDINATES

22 Top Boundaries
 44 Total Boundaries

Boundary No.	X-Left (ft)	Y-Left (ft)	X-Right (ft)	Y-Right (ft)	Soil Type Below Bnd
1	0.00	193.00	100.00	195.00	1
2	100.00	195.00	109.00	203.00	2
3	109.00	203.00	130.00	211.00	2
4	130.00	211.00	140.00	212.00	2
5	140.00	212.00	146.00	216.00	2
6	146.00	216.00	199.00	237.00	2
7	199.00	237.00	205.00	237.00	2
8	205.00	237.00	216.00	243.00	2
9	216.00	243.00	228.00	249.00	3
10	228.00	249.00	230.00	250.00	4
11	230.00	250.00	235.00	252.00	4
12	235.00	252.00	250.00	254.00	4
13	250.00	254.00	250.10	260.00	1
14	250.10	260.00	275.00	260.00	1
15	275.00	260.00	330.00	260.00	4
16	330.00	260.00	380.00	260.00	4
17	380.00	260.00	395.00	270.00	5
18	395.00	270.00	439.00	271.00	4
19	439.00	271.00	439.10	266.00	4
20	439.10	266.00	533.00	266.00	4
21	533.00	266.00	572.00	275.00	4
22	572.00	275.00	600.00	273.00	4
23	250.00	254.00	275.00	260.00	4
24	0.00	151.00	80.00	185.00	3
25	80.00	185.00	170.00	213.00	3
26	170.00	213.00	183.00	220.00	3
27	183.00	220.00	216.00	243.00	3
28	0.00	149.00	80.00	183.00	4
29	80.00	183.00	170.00	211.00	4
30	170.00	211.00	183.00	218.00	4
31	183.00	218.00	216.00	241.00	4
32	216.00	241.00	228.00	249.00	4
33	0.00	122.00	76.00	153.00	5
34	76.00	153.00	250.00	211.00	5
35	250.00	211.00	329.00	260.00	5
36	0.00	120.00	76.00	151.00	6
37	76.00	151.00	250.00	209.00	6

38	250.00	209.00	332.00	260.00	4
39	250.00	209.00	280.00	217.00	6
40	280.00	217.00	292.00	219.00	6
41	292.00	219.00	320.00	223.00	6
42	320.00	223.00	360.00	225.00	6
43	360.00	225.00	400.00	226.00	6
44	400.00	226.00	600.00	230.00	6

Default Y-Origin = 0.00(ft)
 Default X-Plus Value = 0.00(ft)
 Default Y-Plus Value = 0.00(ft)

ISOTROPIC SOIL PARAMETERS

6 Type(s) of Soil

Soil Type No.	Total Unit Wt. (pcf)	Saturated Unit Wt. (pcf)	Cohesion Intercept (psf)	Friction Angle (deg)	Pore Pressure Param. (psf)	Pressure Constant (psf)	Piez. Surface No.
1	130.0	130.0	200.0	29.0	0.00	0.0	0
2	130.0	130.0	270.0	19.0	0.00	0.0	0
3	130.0	130.0	270.0	19.0	0.00	0.0	0
4	130.0	130.0	500.0	30.0	0.00	0.0	0
5	130.0	130.0	270.0	19.0	0.00	0.0	0
6	130.0	130.0	1500.0	39.0	0.00	0.0	0

BOUNDARY LOAD(S)

2 Load(s) Specified

Load No.	X-Left (ft)	X-Right (ft)	Intensity (psf)	Deflection (deg)
1	275.00	372.00	500.0	0.0
2	439.10	524.00	500.0	0.0

NOTE - Intensity Is Specified As A Uniformly Distributed Force Acting On A Horizontally Projected Surface.

Janbus Empirical Coef is being used for the case of c & phi both > 0
 A Critical Failure Surface Searching Method, Using A Random Technique For Generating Sliding Block Surfaces, Has Been Specified.

8000 Trial Surfaces Have Been Generated.

3 Boxes Specified For Generation Of Central Block Base
 Length Of Line Segments For Active And Passive Portions Of Sliding Block Is 40.0

Box No.	X-Left (ft)	Y-Left (ft)	X-Right (ft)	Y-Right (ft)	Height (ft)
1	76.00	152.00	200.00	193.33	2.00
2	248.00	210.00	252.00	210.00	5.00
3	329.00	259.00	332.00	259.00	2.00

Following Are Displayed The Ten Most Critical Of The Trial Failure Surfaces Evaluated. They Are Ordered - Most Critical First.

* * Safety Factors Are Calculated By The Simplified Janbu Method * *

Total Number of Trial Surfaces Attempted = 8000
 Number of Trial Failure Surfaces is Greater Than 5000.
 Statistical Data on FS Values are Not Generated.
 To Generate Stastical Data, Reduce Number of Trial Failure Surfaces to 5000 or less.

Failure Surface Specified By 6 Coordinate Points

Point No.	X-Surf (ft)	Y-Surf (ft)
1	84.467	194.689
2	105.561	182.195
3	144.743	174.151
4	248.372	208.650
5	330.367	258.861
6	331.375	260.000

Factor of Safety
 *** 1.697 ***

Individual data on the 28 slices

Slice No.	Width (ft)	Weight (lbs)	Water Force		Tie Force		Earthquake Force		
			Top (lbs)	Bot (lbs)	Norm (lbs)	Tan (lbs)	Hor (lbs)	Ver (lbs)	Surcharge (lbs)

1	9.2	3358.9	0.0	0.0	0.	0.	0.0	0.0	0.0
2	2.2	1813.9	0.0	0.0	0.	0.	0.0	0.0	0.0
3	4.1	4430.4	0.0	0.0	0.	0.	0.0	0.0	0.0
4	5.6	9852.6	0.0	0.0	0.	0.	0.0	0.0	0.0
5	3.4	8777.1	0.0	0.0	0.	0.	0.0	0.0	0.0
6	21.0	75531.1	0.0	0.0	0.	0.	0.0	0.0	0.0
7	10.0	45953.7	0.0	0.0	0.	0.	0.0	0.0	0.0
8	1.5	7164.2	0.0	0.0	0.	0.	0.0	0.0	0.0
9	3.3	16850.0	0.0	0.0	0.	0.	0.0	0.0	0.0
10	1.3	6733.8	0.0	0.0	0.	0.	0.0	0.0	0.0
11	24.0	131634.9	0.0	0.0	0.	0.	0.0	0.0	0.0
12	13.0	73281.9	0.0	0.0	0.	0.	0.0	0.0	0.0
13	16.0	92102.7	0.0	0.0	0.	0.	0.0	0.0	0.0
14	6.0	34154.6	0.0	0.0	0.	0.	0.0	0.0	0.0
15	11.0	62860.3	0.0	0.0	0.	0.	0.0	0.0	0.0
16	12.0	71962.5	0.0	0.0	0.	0.	0.0	0.0	0.0
17	2.0	12297.9	0.0	0.0	0.	0.	0.0	0.0	0.0
18	5.0	30962.3	0.0	0.0	0.	0.	0.0	0.0	0.0
19	13.4	80776.5	0.0	0.0	0.	0.	0.0	0.0	0.0
20	1.6	9470.5	0.0	0.0	0.	0.	0.0	0.0	0.0
21	0.1	615.2	0.0	0.0	0.	0.	0.0	0.0	0.0
22	24.9	138116.6	0.0	0.0	0.	0.	0.0	0.0	0.0
23	42.5	121718.7	0.0	0.0	0.	0.	0.0	0.0	21248.5
24	11.5	8221.9	0.0	0.0	0.	0.	0.0	0.0	5751.5
25	1.0	217.1	0.0	0.0	0.	0.	0.0	0.0	500.0
26	0.4	59.7	0.0	0.0	0.	0.	0.0	0.0	183.6
27	0.2	31.6	0.0	0.0	0.	0.	0.0	0.0	121.2
28	0.8	43.0	0.0	0.0	0.	0.	0.0	0.0	382.5

Failure Surface Specified By 6 Coordinate Points

Point No.	X-Surf (ft)	Y-Surf (ft)
1	84.467	194.689
2	105.561	182.195
3	144.743	174.151
4	248.372	208.650
5	330.367	258.861
6	331.375	260.000

Factor of Safety
 *** 1.697 ***

Failure Surface Specified By 6 Coordinate Points

Point No.	X-Surf (ft)	Y-Surf (ft)
1	84.467	194.689
2	105.561	182.195
3	144.743	174.151
4	248.372	208.650
5	330.367	258.861
6	331.375	260.000

Factor of Safety
 *** 1.697 ***

Failure Surface Specified By 6 Coordinate Points

Point No.	X-Surf (ft)	Y-Surf (ft)
1	84.467	194.689
2	105.561	182.195
3	144.743	174.151
4	248.372	208.650
5	330.367	258.861
6	331.375	260.000

Factor of Safety
 *** 1.697 ***

Failure Surface Specified By 6 Coordinate Points

Point No.	X-Surf (ft)	Y-Surf (ft)
1	84.467	194.689
2	105.561	182.195
3	144.743	174.151

4	248.372	208.650
5	330.367	258.861
6	331.375	260.000
Factor of Safety		
***	1.697	***
Failure Surface Specified By 6 Coordinate Points		
Point	X-Surf	Y-Surf
No.	(ft)	(ft)
1	84.467	194.689
2	105.561	182.195
3	144.743	174.151
4	248.372	208.650
5	330.367	258.861
6	331.375	260.000
Factor of Safety		
***	1.697	***
Failure Surface Specified By 6 Coordinate Points		
Point	X-Surf	Y-Surf
No.	(ft)	(ft)
1	84.467	194.689
2	105.561	182.195
3	144.743	174.151
4	248.372	208.650
5	330.367	258.861
6	331.375	260.000
Factor of Safety		
***	1.697	***
Failure Surface Specified By 6 Coordinate Points		
Point	X-Surf	Y-Surf
No.	(ft)	(ft)
1	84.467	194.689
2	105.561	182.195
3	144.743	174.151
4	248.372	208.650
5	330.367	258.861
6	331.375	260.000
Factor of Safety		
***	1.697	***
Failure Surface Specified By 6 Coordinate Points		
Point	X-Surf	Y-Surf
No.	(ft)	(ft)
1	84.467	194.689
2	105.561	182.195
3	144.743	174.151
4	248.372	208.650
5	330.367	258.861
6	331.375	260.000
Factor of Safety		
***	1.697	***
Failure Surface Specified By 6 Coordinate Points		
Point	X-Surf	Y-Surf
No.	(ft)	(ft)
1	84.467	194.689
2	105.561	182.195
3	144.743	174.151
4	248.372	208.650
5	330.367	258.861
6	331.375	260.000
Factor of Safety		
***	1.697	***
**** END OF GSTABL7 OUTPUT ****		

F-F' / Alternate Design / Search Along Clay / Pseudostatic

z:\2010\10132-01 south shores church - dana point\engineering\2013_05\alternate design\ff_1p.pl2 Run By: Username 5/9/2013 06:58AM

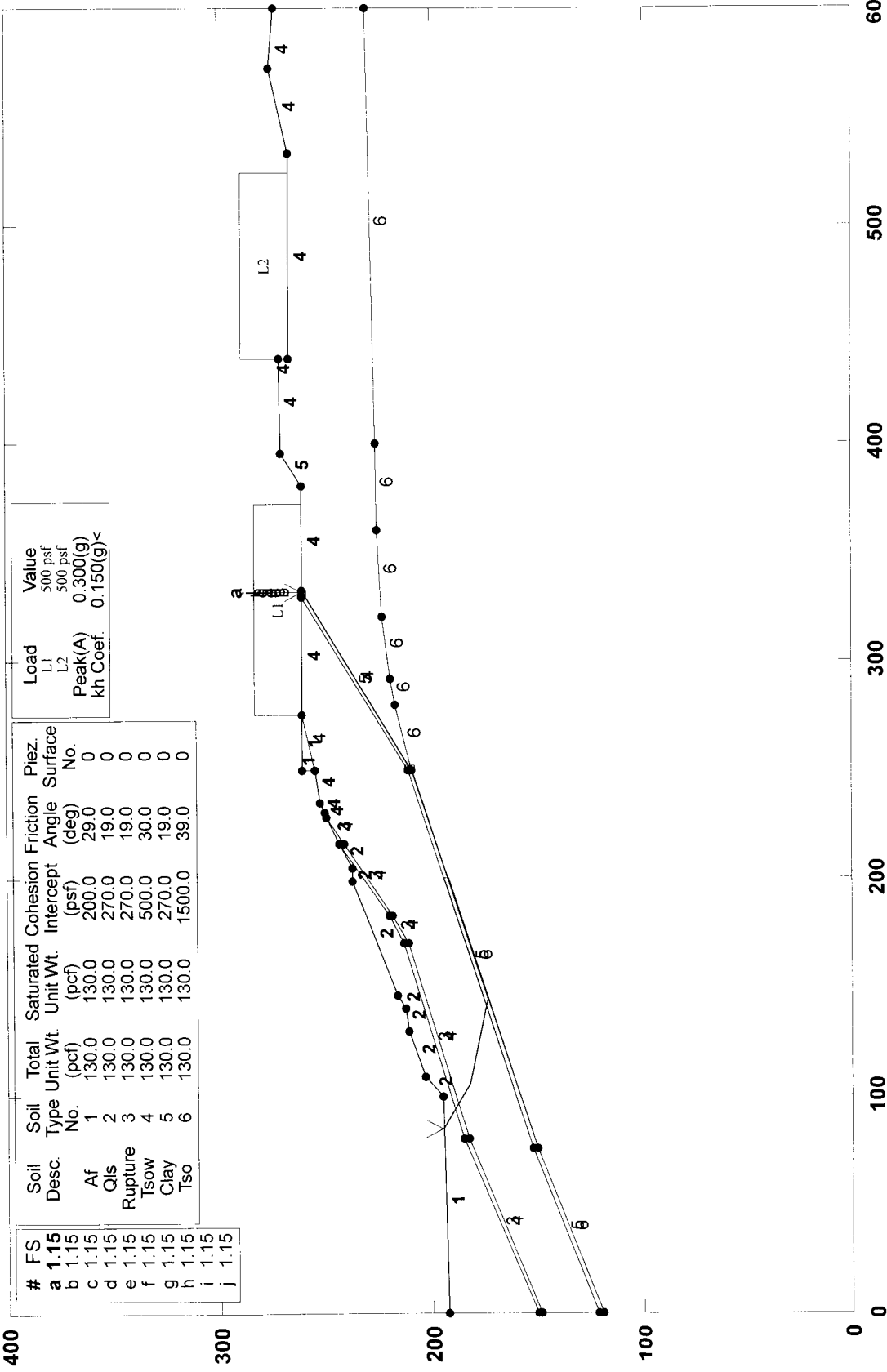

GSTABL7 v.2 FSmin=1.15

Safety Factors Are Calculated By The Simplified Janbu Method for the case of c & phi both > 0

*** GSTABL7 ***

** GSTABL7 by Dr. Garry H. Gregory, Ph.D., P.E., D.GE **
 ** Original Version 1.0, January 1996; Current Ver. 2.005.2, Jan. 2011 **
 (All Rights Reserved-Unauthorized Use Prohibited)

SLOPE STABILITY ANALYSIS SYSTEM

Modified Bishop, Simplified Janbu, or GLE Method of Slices.
 (Includes Spencer & Morgenstern-Price Type Analysis)
 Including Pier/Pile, Reinforcement, Soil Nail, Tieback,
 Nonlinear Undrained Shear Strength, Curved Phi Envelope,
 Anisotropic Soil, Fiber-Reinforced Soil, Boundary Loads, Water
 Surfaces, Pseudo-Static & Newmark Earthquake, and Applied Forces.

Analysis Run Date: 5/9/2013
 Time of Run: 06:58AM
 Run By: Username
 Input Data Filename: Z:\2010\10132-01 South Shores Church - Dana Point\Engineerin
 g\2013_05\Alternate Design\ff'_lp.
 Output Filename: Z:\2010\10132-01 South Shores Church - Dana Point\Engineerin
 g\2013_05\Alternate Design\ff'_lp.OUT
 Unit System: English
 Plotted Output Filename: Z:\2010\10132-01 South Shores Church - Dana Point\Engineerin
 g\2013_05\Alternate Design\ff'_lp.PLT
 PROBLEM DESCRIPTION: F-F' / Alternate Design / Search Along
 Clay / Pseudostatic

BOUNDARY COORDINATES

22 Top Boundaries
 44 Total Boundaries

Boundary No.	X-Left (ft)	Y-Left (ft)	X-Right (ft)	Y-Right (ft)	Soil Type Below Bnd
1	0.00	193.00	100.00	195.00	1
2	100.00	195.00	109.00	203.00	2
3	109.00	203.00	130.00	211.00	2
4	130.00	211.00	140.00	212.00	2
5	140.00	212.00	146.00	216.00	2
6	146.00	216.00	199.00	237.00	2
7	199.00	237.00	205.00	237.00	2
8	205.00	237.00	216.00	243.00	2
9	216.00	243.00	228.00	249.00	3
10	228.00	249.00	230.00	250.00	4
11	230.00	250.00	235.00	252.00	4
12	235.00	252.00	250.00	254.00	4
13	250.00	254.00	250.10	260.00	1
14	250.10	260.00	275.00	260.00	1
15	275.00	260.00	330.00	260.00	4
16	330.00	260.00	380.00	260.00	4
17	380.00	260.00	395.00	270.00	5
18	395.00	270.00	439.00	271.00	4
19	439.00	271.00	439.10	266.00	4
20	439.10	266.00	533.00	266.00	4
21	533.00	266.00	572.00	275.00	4
22	572.00	275.00	600.00	273.00	4
23	250.00	254.00	275.00	260.00	4
24	0.00	151.00	80.00	185.00	3
25	80.00	185.00	170.00	213.00	3
26	170.00	213.00	183.00	220.00	3
27	183.00	220.00	216.00	243.00	3
28	0.00	149.00	80.00	183.00	4
29	80.00	183.00	170.00	211.00	4
30	170.00	211.00	183.00	218.00	4
31	183.00	218.00	216.00	241.00	4
32	216.00	241.00	228.00	249.00	4
33	0.00	122.00	76.00	153.00	5
34	76.00	153.00	250.00	211.00	5
35	250.00	211.00	329.00	260.00	5
36	0.00	120.00	76.00	151.00	6
37	76.00	151.00	250.00	209.00	6
38	250.00	209.00	332.00	260.00	4

39	250.00	209.00	280.00	217.00	6
40	280.00	217.00	292.00	219.00	6
41	292.00	219.00	320.00	223.00	6
42	320.00	223.00	360.00	225.00	6
43	360.00	225.00	400.00	226.00	6
44	400.00	226.00	600.00	230.00	6

Default Y-Origin = 0.00(ft)
 Default X-Plus Value = 0.00(ft)
 Default Y-Plus Value = 0.00(ft)

ISOTROPIC SOIL PARAMETERS

6 Type(s) of Soil

Soil Type No.	Total Unit Wt. (pcf)	Saturated Unit Wt. (pcf)	Cohesion Intercept (psf)	Friction Angle (deg)	Pore Pressure Param. (psf)	Pressure Constant (psf)	Piez. Surface No.
1	130.0	130.0	200.0	29.0	0.00	0.0	0
2	130.0	130.0	270.0	19.0	0.00	0.0	0
3	130.0	130.0	270.0	19.0	0.00	0.0	0
4	130.0	130.0	500.0	30.0	0.00	0.0	0
5	130.0	130.0	270.0	19.0	0.00	0.0	0
6	130.0	130.0	1500.0	39.0	0.00	0.0	0

BOUNDARY LOAD(S)

2 Load(s) Specified

Load No.	X-Left (ft)	X-Right (ft)	Intensity (psf)	Deflection (deg)
1	275.00	372.00	500.0	0.0
2	439.10	524.00	500.0	0.0

NOTE - Intensity Is Specified As A Uniformly Distributed Force Acting On A Horizontally Projected Surface.

Specified Peak Ground Acceleration Coefficient (A) = 0.300(g)
 Specified Horizontal Earthquake Coefficient (kh) = 0.150(g)
 Specified Vertical Earthquake Coefficient (kv) = 0.000(g)
 Specified Seismic Pore-Pressure Factor = 0.000
 Janbus Empirical Coef is being used for the case of c & phi both > 0
 A Critical Failure Surface Searching Method, Using A Random Technique For Generating Sliding Block Surfaces, Has Been Specified.

8000 Trial Surfaces Have Been Generated.

3 Boxes Specified For Generation Of Central Block Base
 Length Of Line Segments For Active And Passive Portions Of Sliding Block Is 40.0

Box No.	X-Left (ft)	Y-Left (ft)	X-Right (ft)	Y-Right (ft)	Height (ft)
1	76.00	152.00	200.00	193.33	2.00
2	248.00	210.00	252.00	210.00	5.00
3	329.00	259.00	332.00	259.00	2.00

Following Are Displayed The Ten Most Critical Of The Trial Failure Surfaces Evaluated. They Are Ordered - Most Critical First.

* * Safety Factors Are Calculated By The Simplified Janbu Method * *

Total Number of Trial Surfaces Attempted = 8000
 Number of Trial Failure Surfaces is Greater Than 5000.
 Statistical Data on FS Values are Not Generated.
 To Generate Stastical Data, Reduce Number of Trial Failure Surfaces to 5000 or less.

Failure Surface Specified By 6 Coordinate Points

Point No.	X-Surf (ft)	Y-Surf (ft)
1	84.467	194.689
2	105.561	182.195
3	144.743	174.151
4	248.372	208.650
5	330.367	258.861
6	331.375	260.000

Factor of Safety
 *** 1.148 ***

Individual data on the 28 slices
 Water Water Tie Tie Earthquake

Slice No.	Width (ft)	Weight (lbs)	Force Top (lbs)	Force Bot (lbs)	Force Norm (lbs)	Force Tan (lbs)	Force Hor (lbs)	Force Ver (lbs)	Surcharge Load (lbs)
1	9.2	3358.9	0.0	0.0	0.	0.	503.8	0.0	0.0
2	2.2	1813.9	0.0	0.0	0.	0.	272.1	0.0	0.0
3	4.1	4430.4	0.0	0.0	0.	0.	664.6	0.0	0.0
4	5.6	9852.6	0.0	0.0	0.	0.	1477.9	0.0	0.0
5	3.4	8777.1	0.0	0.0	0.	0.	1316.6	0.0	0.0
6	21.0	75531.1	0.0	0.0	0.	0.	11329.7	0.0	0.0
7	10.0	45953.7	0.0	0.0	0.	0.	6893.1	0.0	0.0
8	1.5	7164.2	0.0	0.0	0.	0.	1074.6	0.0	0.0
9	3.3	16850.0	0.0	0.0	0.	0.	2527.5	0.0	0.0
10	1.3	6733.8	0.0	0.0	0.	0.	1010.1	0.0	0.0
11	24.0	131634.9	0.0	0.0	0.	0.	19745.2	0.0	0.0
12	13.0	73281.9	0.0	0.0	0.	0.	10992.3	0.0	0.0
13	16.0	92102.7	0.0	0.0	0.	0.	13815.4	0.0	0.0
14	6.0	34154.6	0.0	0.0	0.	0.	5123.2	0.0	0.0
15	11.0	62860.3	0.0	0.0	0.	0.	9429.0	0.0	0.0
16	12.0	71962.5	0.0	0.0	0.	0.	10794.4	0.0	0.0
17	2.0	12297.9	0.0	0.0	0.	0.	1844.7	0.0	0.0
18	5.0	30962.3	0.0	0.0	0.	0.	4644.3	0.0	0.0
19	13.4	80776.5	0.0	0.0	0.	0.	12116.5	0.0	0.0
20	1.6	9470.5	0.0	0.0	0.	0.	1420.6	0.0	0.0
21	0.1	615.2	0.0	0.0	0.	0.	92.3	0.0	0.0
22	24.9	138116.6	0.0	0.0	0.	0.	20717.5	0.0	0.0
23	42.5	121718.7	0.0	0.0	0.	0.	18257.8	0.0	21248.5
24	11.5	8221.9	0.0	0.0	0.	0.	1233.3	0.0	5751.5
25	1.0	217.1	0.0	0.0	0.	0.	32.6	0.0	500.0
26	0.4	59.7	0.0	0.0	0.	0.	9.0	0.0	183.6
27	0.2	31.6	0.0	0.0	0.	0.	4.7	0.0	121.2
28	0.8	43.0	0.0	0.0	0.	0.	6.4	0.0	382.5

Failure Surface Specified By 6 Coordinate Points

Point No.	X-Surf (ft)	Y-Surf (ft)
1	84.467	194.689
2	105.561	182.195
3	144.743	174.151
4	248.372	208.650
5	330.367	258.861
6	331.375	260.000

Factor of Safety
*** 1.148 ***

Failure Surface Specified By 6 Coordinate Points

Point No.	X-Surf (ft)	Y-Surf (ft)
1	84.467	194.689
2	105.561	182.195
3	144.743	174.151
4	248.372	208.650
5	330.367	258.861
6	331.375	260.000

Factor of Safety
*** 1.148 ***

Failure Surface Specified By 6 Coordinate Points

Point No.	X-Surf (ft)	Y-Surf (ft)
1	84.467	194.689
2	105.561	182.195
3	144.743	174.151
4	248.372	208.650
5	330.367	258.861
6	331.375	260.000

Factor of Safety
*** 1.148 ***

Failure Surface Specified By 6 Coordinate Points

Point No.	X-Surf (ft)	Y-Surf (ft)
-----------	-------------	-------------

1	84.467	194.689
2	105.561	182.195
3	144.743	174.151
4	248.372	208.650
5	330.367	258.861
6	331.375	260.000

Factor of Safety
 *** 1.148 ***

Failure Surface Specified By 6 Coordinate Points

Point No.	X-Surf (ft)	Y-Surf (ft)
1	84.467	194.689
2	105.561	182.195
3	144.743	174.151
4	248.372	208.650
5	330.367	258.861
6	331.375	260.000

Factor of Safety
 *** 1.148 ***

Failure Surface Specified By 6 Coordinate Points

Point No.	X-Surf (ft)	Y-Surf (ft)
1	84.467	194.689
2	105.561	182.195
3	144.743	174.151
4	248.372	208.650
5	330.367	258.861
6	331.375	260.000

Factor of Safety
 *** 1.148 ***

Failure Surface Specified By 6 Coordinate Points

Point No.	X-Surf (ft)	Y-Surf (ft)
1	84.467	194.689
2	105.561	182.195
3	144.743	174.151
4	248.372	208.650
5	330.367	258.861
6	331.375	260.000

Factor of Safety
 *** 1.148 ***

Failure Surface Specified By 6 Coordinate Points

Point No.	X-Surf (ft)	Y-Surf (ft)
1	84.467	194.689
2	105.561	182.195
3	144.743	174.151
4	248.372	208.650
5	330.367	258.861
6	331.375	260.000

Factor of Safety
 *** 1.148 ***

Failure Surface Specified By 6 Coordinate Points

Point No.	X-Surf (ft)	Y-Surf (ft)
1	84.467	194.689
2	105.561	182.195
3	144.743	174.151
4	248.372	208.650
5	330.367	258.861
6	331.375	260.000

Factor of Safety
 *** 1.148 ***

**** END OF GSTABL7 OUTPUT ****

F-F' / Alternate Design / Circular Search

z:\2010\10132-01 south shores church - dana point\engineering\2013_05\alternate design\ff_1c.pl2 Run By: Username 5/9/2013 07:03AM

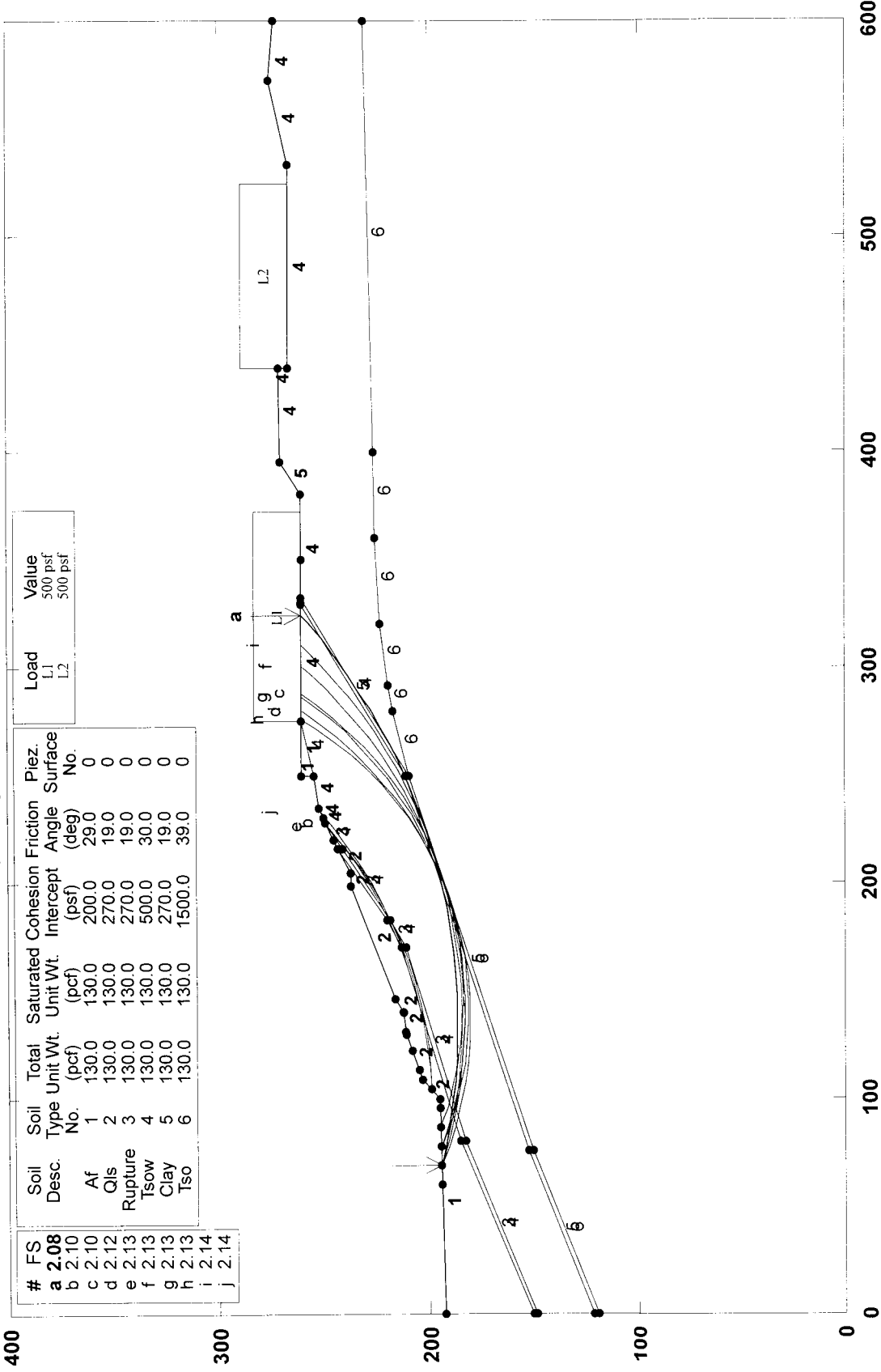

GSTABL7 v.2 FSmin=2.08

Safety Factors Are Calculated By The Modified Bishop Method

*** GSTABL7 ***

** GSTABL7 by Dr. Garry H. Gregory, Ph.D., P.E., D.GE **
 ** Original Version 1.0, January 1996; Current Ver. 2.005.2, Jan. 2011 **
 (All Rights Reserved-Unauthorized Use Prohibited)

SLOPE STABILITY ANALYSIS SYSTEM

Modified Bishop, Simplified Janbu, or GLE Method of Slices.
 (Includes Spencer & Morgenstern-Price Type Analysis)
 Including Pier/Pile, Reinforcement, Soil Nail, Tieback,
 Nonlinear Undrained Shear Strength, Curved Phi Envelope,
 Anisotropic Soil, Fiber-Reinforced Soil, Boundary Loads, Water
 Surfaces, Pseudo-Static & Newmark Earthquake, and Applied Forces.

Analysis Run Date: 5/9/2013
 Time of Run: 07:03AM
 Run By: Username
 Input Data Filename: Z:\2010\10132-01 South Shores Church - Dana Point\Engineerin
 g\2013_05\Alternate Design\ff'_lc.
 Output Filename: Z:\2010\10132-01 South Shores Church - Dana Point\Engineerin
 g\2013_05\Alternate Design\ff'_lc.OUT
 Unit System: English
 Plotted Output Filename: Z:\2010\10132-01 South Shores Church - Dana Point\Engineerin
 g\2013_05\Alternate Design\ff'_lc.PLT
 PROBLEM DESCRIPTION: F-F' / Alternate Design / Circular
 Search

BOUNDARY COORDINATES

22 Top Boundaries
 44 Total Boundaries

Boundary No.	X-Left (ft)	Y-Left (ft)	X-Right (ft)	Y-Right (ft)	Soil Type Below Bnd
1	0.00	193.00	100.00	195.00	1
2	100.00	195.00	109.00	203.00	2
3	109.00	203.00	130.00	211.00	2
4	130.00	211.00	140.00	212.00	2
5	140.00	212.00	146.00	216.00	2
6	146.00	216.00	199.00	237.00	2
7	199.00	237.00	205.00	237.00	2
8	205.00	237.00	216.00	243.00	2
9	216.00	243.00	228.00	249.00	3
10	228.00	249.00	230.00	250.00	4
11	230.00	250.00	235.00	252.00	4
12	235.00	252.00	250.00	254.00	4
13	250.00	254.00	250.10	260.00	1
14	250.10	260.00	275.00	260.00	1
15	275.00	260.00	330.00	260.00	4
16	330.00	260.00	380.00	260.00	4
17	380.00	260.00	395.00	270.00	5
18	395.00	270.00	439.00	271.00	4
19	439.00	271.00	439.10	266.00	4
20	439.10	266.00	533.00	266.00	4
21	533.00	266.00	572.00	275.00	4
22	572.00	275.00	600.00	273.00	4
23	250.00	254.00	275.00	260.00	4
24	0.00	151.00	80.00	185.00	3
25	80.00	185.00	170.00	213.00	3
26	170.00	213.00	183.00	220.00	3
27	183.00	220.00	216.00	243.00	3
28	0.00	149.00	80.00	183.00	4
29	80.00	183.00	170.00	211.00	4
30	170.00	211.00	183.00	218.00	4
31	183.00	218.00	216.00	241.00	4
32	216.00	241.00	228.00	249.00	4
33	0.00	122.00	76.00	153.00	5
34	76.00	153.00	250.00	211.00	5
35	250.00	211.00	329.00	260.00	5
36	0.00	120.00	76.00	151.00	6
37	76.00	151.00	250.00	209.00	6

38	250.00	209.00	332.00	260.00	4
39	250.00	209.00	280.00	217.00	6
40	280.00	217.00	292.00	219.00	6
41	292.00	219.00	320.00	223.00	6
42	320.00	223.00	360.00	225.00	6
43	360.00	225.00	400.00	226.00	6
44	400.00	226.00	600.00	230.00	6

Default Y-Origin = 0.00(ft)
 Default X-Plus Value = 0.00(ft)
 Default Y-Plus Value = 0.00(ft)

ISOTROPIC SOIL PARAMETERS

6 Type(s) of Soil

Soil Type No.	Total Unit Wt. (pcf)	Saturated Unit Wt. (pcf)	Cohesion Intercept (psf)	Friction Angle (deg)	Pore Pressure Param. (psf)	Pressure Constant (psf)	Piez. Surface No.
1	130.0	130.0	200.0	29.0	0.00	0.0	0
2	130.0	130.0	270.0	19.0	0.00	0.0	0
3	130.0	130.0	270.0	19.0	0.00	0.0	0
4	130.0	130.0	500.0	30.0	0.00	0.0	0
5	130.0	130.0	270.0	19.0	0.00	0.0	0
6	130.0	130.0	1500.0	39.0	0.00	0.0	0

BOUNDARY LOAD(S)

2 Load(s) Specified

Load No.	X-Left (ft)	X-Right (ft)	Intensity (psf)	Deflection (deg)
1	275.00	372.00	500.0	0.0
2	439.10	524.00	500.0	0.0

NOTE - Intensity Is Specified As A Uniformly Distributed Force Acting On A Horizontally Projected Surface.

A Critical Failure Surface Searching Method, Using A Random Technique For Generating Circular Surfaces, Has Been Specified. 5000 Trial Surfaces Have Been Generated.

500 Surface(s) Initiate(s) From Each Of 10 Points Equally Spaced Along The Ground Surface Between X = 60.00(ft) and X = 140.00(ft)
 Each Surface Terminates Between X = 220.00(ft) and X = 350.00(ft)

Unless Further Limitations Were Imposed, The Minimum Elevation At Which A Surface Extends Is Y = 0.00(ft)
 10.00(ft) Line Segments Define Each Trial Failure Surface. Following Are Displayed The Ten Most Critical Of The Trial Failure Surfaces Evaluated. They Are

Ordered - Most Critical First.

* * Safety Factors Are Calculated By The Modified Bishop Method * *

Total Number of Trial Surfaces Attempted = 5000

Number of Trial Surfaces With Valid FS = 5000

Statistical Data On All Valid FS Values:

FS Max = 6.400 FS Min = 2.083 FS Ave = 3.838

Standard Deviation = 1.056 Coefficient of Variation = 27.51 %

Failure Surface Specified By 29 Coordinate Points

Point No.	X-Surf (ft)	Y-Surf (ft)
1	68.889	194.378
2	78.648	192.196
3	88.479	190.365
4	98.369	188.887
5	108.306	187.763
6	118.276	186.996
7	128.268	186.585
8	138.268	186.531
9	148.263	186.836
10	158.241	187.497
11	168.189	188.515
12	178.095	189.887
13	187.945	191.613
14	197.726	193.690
15	207.428	196.116

16	217.036	198.887
17	226.540	201.999
18	235.925	205.449
19	245.182	209.233
20	254.297	213.345
21	263.260	217.781
22	272.058	222.534
23	280.681	227.599
24	289.117	232.968
25	297.355	238.636
26	305.386	244.595
27	313.199	250.837
28	320.783	257.354
29	323.648	260.000

Circle Center At X = 134.760 ; Y = 466.161 ; and Radius = 279.652

Factor of Safety

*** 2.083 ***

Slice No.	Width (ft)	Weight (lbs)	Water		Tie		Earthquake		
			Force Top (lbs)	Force Bot (lbs)	Force Norm (lbs)	Force Tan (lbs)	Force Hor (lbs)	Force Ver (lbs)	Surcharge Load (lbs)
1	9.8	1507.5	0.0	0.0	0.	0.	0.0	0.0	0.0
2	9.8	4332.9	0.0	0.0	0.	0.	0.0	0.0	0.0
3	5.9	3776.8	0.0	0.0	0.	0.	0.0	0.0	0.0
4	4.0	2963.2	0.0	0.0	0.	0.	0.0	0.0	0.0
5	0.4	322.4	0.0	0.0	0.	0.	0.0	0.0	0.0
6	1.2	989.7	0.0	0.0	0.	0.	0.0	0.0	0.0
7	8.3	11292.6	0.0	0.0	0.	0.	0.0	0.0	0.0
8	0.7	1349.6	0.0	0.0	0.	0.	0.0	0.0	0.0
9	9.3	21000.1	0.0	0.0	0.	0.	0.0	0.0	0.0
10	10.0	28117.2	0.0	0.0	0.	0.	0.0	0.0	0.0
11	1.7	5424.6	0.0	0.0	0.	0.	0.0	0.0	0.0
12	8.3	26719.6	0.0	0.0	0.	0.	0.0	0.0	0.0
13	1.7	5710.1	0.0	0.0	0.	0.	0.0	0.0	0.0
14	6.0	21313.2	0.0	0.0	0.	0.	0.0	0.0	0.0
15	2.3	8722.2	0.0	0.0	0.	0.	0.0	0.0	0.0
16	10.0	41129.2	0.0	0.0	0.	0.	0.0	0.0	0.0
17	9.9	45024.9	0.0	0.0	0.	0.	0.0	0.0	0.0
18	1.8	8594.5	0.0	0.0	0.	0.	0.0	0.0	0.0
19	8.1	39762.8	0.0	0.0	0.	0.	0.0	0.0	0.0
20	4.9	25107.3	0.0	0.0	0.	0.	0.0	0.0	0.0
21	4.9	26007.0	0.0	0.0	0.	0.	0.0	0.0	0.0
22	9.8	53289.1	0.0	0.0	0.	0.	0.0	0.0	0.0
23	1.3	7102.5	0.0	0.0	0.	0.	0.0	0.0	0.0
24	0.1	590.8	0.0	0.0	0.	0.	0.0	0.0	0.0
25	5.9	32357.3	0.0	0.0	0.	0.	0.0	0.0	0.0
26	2.4	13208.4	0.0	0.0	0.	0.	0.0	0.0	0.0
27	8.6	48264.3	0.0	0.0	0.	0.	0.0	0.0	0.0
28	1.0	5997.9	0.0	0.0	0.	0.	0.0	0.0	0.0
29	9.5	56151.3	0.0	0.0	0.	0.	0.0	0.0	0.0
30	1.5	8803.2	0.0	0.0	0.	0.	0.0	0.0	0.0
31	2.0	12115.1	0.0	0.0	0.	0.	0.0	0.0	0.0
32	5.0	30426.3	0.0	0.0	0.	0.	0.0	0.0	0.0
33	0.9	5628.4	0.0	0.0	0.	0.	0.0	0.0	0.0
34	9.3	54631.2	0.0	0.0	0.	0.	0.0	0.0	0.0
35	1.4	7794.8	0.0	0.0	0.	0.	0.0	0.0	0.0
36	3.5	19362.6	0.0	0.0	0.	0.	0.0	0.0	0.0
37	0.1	592.5	0.0	0.0	0.	0.	0.0	0.0	0.0
38	2.3	14389.5	0.0	0.0	0.	0.	0.0	0.0	0.0
39	1.9	11584.6	0.0	0.0	0.	0.	0.0	0.0	0.0
40	9.0	51774.5	0.0	0.0	0.	0.	0.0	0.0	0.0
41	6.5	34357.4	0.0	0.0	0.	0.	0.0	0.0	0.0
42	2.3	11213.2	0.0	0.0	0.	0.	0.0	0.0	0.0
43	2.9	13998.6	0.0	0.0	0.	0.	0.0	0.0	0.0
44	5.7	25160.1	0.0	0.0	0.	0.	0.0	0.0	2840.3
45	8.4	32589.8	0.0	0.0	0.	0.	0.0	0.0	4218.0

46	5.5	17859.5	0.0	0.0	0.	0.	0.0	0.0	2730.9
47	2.8	8057.1	0.0	0.0	0.	0.	0.0	0.0	1388.4
48	8.0	19193.5	0.0	0.0	0.	0.	0.0	0.0	4015.4
49	4.2	7565.1	0.0	0.0	0.	0.	0.0	0.0	2122.4
50	3.6	4911.1	0.0	0.0	0.	0.	0.0	0.0	1783.9
51	7.6	5821.6	0.0	0.0	0.	0.	0.0	0.0	3792.2
52	2.9	492.7	0.0	0.0	0.	0.	0.0	0.0	1432.5

Failure Surface Specified By 15 Coordinate Points

Point No.	X-Surf (ft)	Y-Surf (ft)
1	104.444	198.951
2	114.420	199.655
3	124.347	200.856
4	134.202	202.552
5	143.961	204.737
6	153.598	207.407
7	163.089	210.554
8	172.412	214.172
9	181.543	218.250
10	190.459	222.779
11	199.137	227.747
12	207.557	233.143
13	215.696	238.952
14	223.536	245.160
15	227.808	248.904

Circle Center At X = 95.331 ; Y = 399.007 ; and Radius = 200.264

Factor of Safety
*** 2.101 ***

Failure Surface Specified By 24 Coordinate Points

Point No.	X-Surf (ft)	Y-Surf (ft)
1	86.667	194.733
2	96.123	191.480
3	105.754	188.790
4	115.527	186.672
5	125.408	185.135
6	135.363	184.184
7	145.356	183.822
8	155.354	184.050
9	165.320	184.868
10	175.221	186.272
11	185.022	188.258
12	194.689	190.818
13	204.187	193.945
14	213.485	197.626
15	222.549	201.850
16	231.349	206.601
17	239.852	211.863
18	248.031	217.618
19	255.855	223.845
20	263.299	230.522
21	270.335	237.628
22	276.940	245.136
23	283.091	253.021
24	287.901	260.000

Circle Center At X = 146.490 ; Y = 353.145 ; and Radius = 169.331

Factor of Safety
*** 2.104 ***

Failure Surface Specified By 26 Coordinate Points

Point No.	X-Surf (ft)	Y-Surf (ft)
1	68.889	194.378
2	78.179	190.676
3	87.671	187.530
4	97.332	184.950
5	107.129	182.945
6	117.027	181.522

7	126.992	180.686
8	136.989	180.441
9	146.984	180.786
10	156.940	181.720
11	166.823	183.241
12	176.600	185.343
13	186.235	188.019
14	195.696	191.259
15	204.949	195.052
16	213.961	199.385
17	222.702	204.243
18	231.141	209.608
19	239.248	215.463
20	246.995	221.786
21	254.355	228.556
22	261.303	235.748
23	267.813	243.338
24	273.864	251.300
25	279.435	259.605
26	279.667	260.000

Circle Center At X = 136.149 ; Y = 349.660 ; and Radius = 169.223

Factor of Safety
 *** 2.123 ***

Failure Surface Specified By 15 Coordinate Points

Point No.	X-Surf (ft)	Y-Surf (ft)
1	104.444	198.951
2	114.437	199.331
3	124.394	200.262
4	134.284	201.742
5	144.077	203.766
6	153.743	206.328
7	163.253	209.420
8	172.577	213.033
9	181.688	217.155
10	190.557	221.775
11	199.158	226.877
12	207.463	232.447
13	215.448	238.467
14	223.088	244.918
15	226.750	248.375

Circle Center At X = 102.569 ; Y = 379.884 ; and Radius = 180.944

Factor of Safety
 *** 2.127 ***

Failure Surface Specified By 27 Coordinate Points

Point No.	X-Surf (ft)	Y-Surf (ft)
1	68.889	194.378
2	78.440	191.415
3	88.119	188.904
4	97.906	186.849
5	107.778	185.256
6	117.715	184.128
7	127.693	183.467
8	137.691	183.275
9	147.687	183.553
10	157.659	184.299
11	167.585	185.512
12	177.444	187.190
13	187.212	189.328
14	196.870	191.922
15	206.395	194.967
16	215.767	198.454
17	224.965	202.378
18	233.969	206.729
19	242.759	211.498
20	251.315	216.674

21	259.619	222.246
22	267.653	228.201
23	275.398	234.526
24	282.838	241.208
25	289.956	248.231
26	296.737	255.581
27	300.446	260.000

Circle Center At X = 136.779 ; Y = 396.356 ; and Radius = 213.083

Factor of Safety

*** 2.128 ***

Failure Surface Specified By 25 Coordinate Points

Point No.	X-Surf (ft)	Y-Surf (ft)
1	77.778	194.556
2	87.209	191.231
3	96.814	188.447
4	106.561	186.213
5	116.419	184.536
6	126.357	183.421
7	136.342	182.872
8	146.342	182.891
9	156.325	183.477
10	166.258	184.629
11	176.110	186.343
12	185.849	188.613
13	195.443	191.433
14	204.862	194.792
15	214.075	198.681
16	223.052	203.087
17	231.765	207.995
18	240.185	213.389
19	248.285	219.253
20	256.040	225.567
21	263.423	232.311
22	270.412	239.464
23	276.983	247.002
24	283.116	254.900
25	286.631	260.000

Circle Center At X = 141.014 ; Y = 358.910 ; and Radius = 176.100

Factor of Safety

*** 2.131 ***

Failure Surface Specified By 24 Coordinate Points

Point No.	X-Surf (ft)	Y-Surf (ft)
1	77.778	194.556
2	87.041	190.789
3	96.528	187.626
4	106.199	185.081
5	116.013	183.165
6	125.931	181.885
7	135.911	181.246
8	145.911	181.252
9	155.889	181.901
10	165.806	183.193
11	175.618	185.120
12	185.286	187.676
13	194.769	190.849
14	204.029	194.626
15	213.025	198.992
16	221.722	203.929
17	230.082	209.415
18	238.072	215.429
19	245.658	221.945
20	252.808	228.936
21	259.493	236.373
22	265.685	244.226
23	271.358	252.461

24 275.865 260.000
 Circle Center At X = 140.820 ; Y = 336.248 ; and Radius = 155.083
 Factor of Safety
 *** 2.131 ***

Failure Surface Specified By 28 Coordinate Points

Point No.	X-Surf (ft)	Y-Surf (ft)
1	68.889	194.378
2	78.529	191.718
3	88.272	189.468
4	98.102	187.630
5	108.000	186.209
6	117.950	185.207
7	127.933	184.625
8	137.932	184.465
9	147.928	184.727
10	157.905	185.410
11	167.844	186.513
12	177.728	188.035
13	187.538	189.972
14	197.258	192.321
15	206.871	195.079
16	216.358	198.239
17	225.704	201.797
18	234.891	205.745
19	243.904	210.078
20	252.726	214.787
21	261.341	219.864
22	269.735	225.300
23	277.891	231.085
24	285.797	237.209
25	293.437	243.661
26	300.798	250.430
27	307.867	257.503
28	310.161	260.000

Circle Center At X = 136.725 ; Y = 421.316 ; and Radius = 236.860
 Factor of Safety
 *** 2.140 ***

Failure Surface Specified By 16 Coordinate Points

Point No.	X-Surf (ft)	Y-Surf (ft)
1	104.444	198.951
2	114.424	199.588
3	124.361	200.711
4	134.231	202.319
5	144.010	204.407
6	153.676	206.970
7	163.206	210.002
8	172.575	213.496
9	181.763	217.443
10	190.748	221.835
11	199.507	226.659
12	208.019	231.906
13	216.266	237.563
14	224.226	243.615
15	231.882	250.049
16	233.215	251.286

Circle Center At X = 96.462 ; Y = 403.179 ; and Radius = 204.384
 Factor of Safety
 *** 2.142 ***

**** END OF GSTABL7 OUTPUT ****

F-F' / Alternate Design / Circular Search / Circular Search / Pseudostatic

z:\2010\10132-01 south shores church - dana point\engineering\2013_05\alternate design\ff_1cp.pl2 Run By: Username 5/9/2013 07:05AM

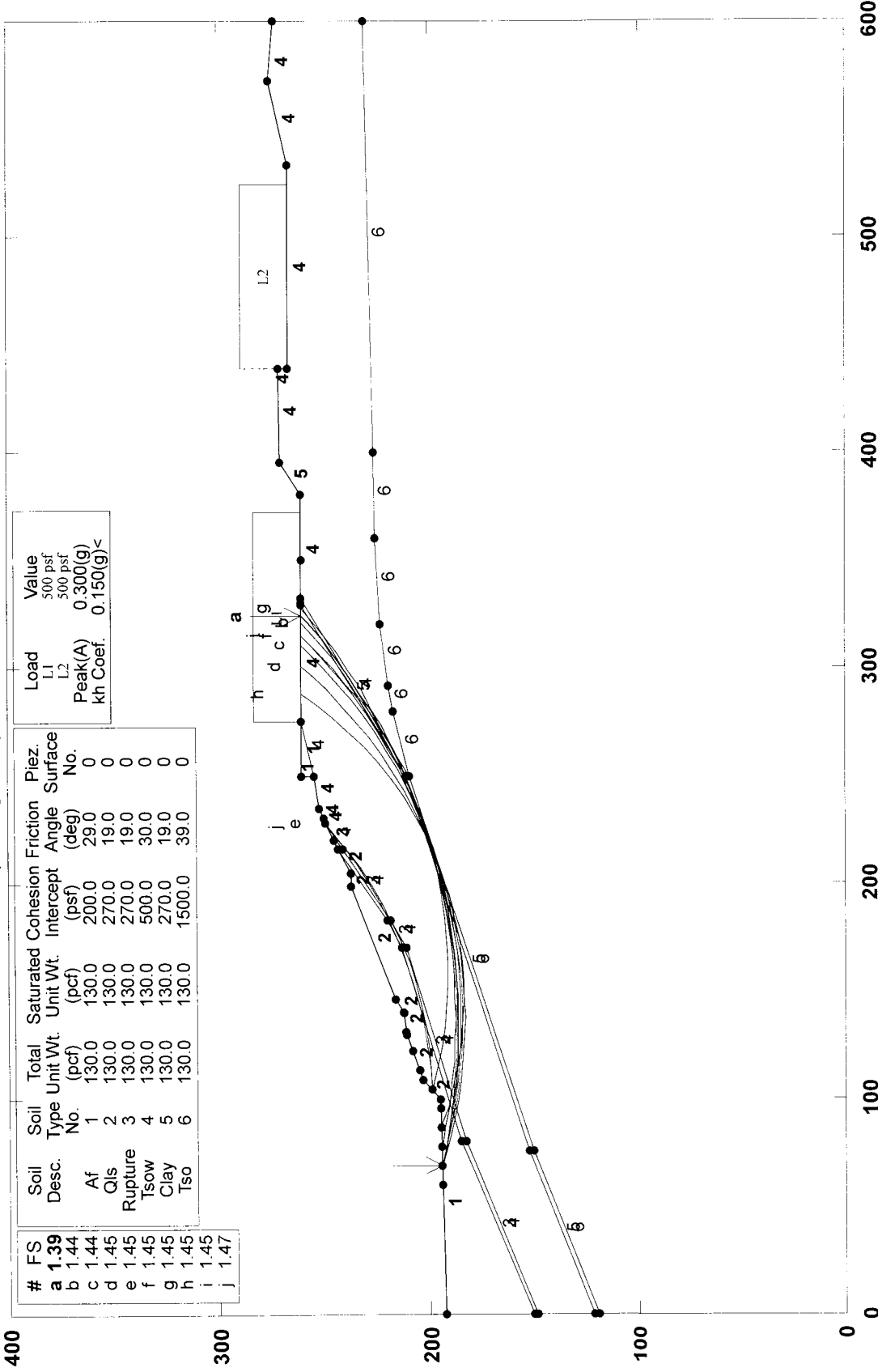

GSTABL7 v.2 FSmin=1.39

Safety Factors Are Calculated By The Modified Bishop Method

*** GSTABL7 ***

** GSTABL7 by Dr. Garry H. Gregory, Ph.D., P.E., D.GE **
 ** Original Version 1.0, January 1996; Current Ver. 2.005.2, Jan. 2011 **
 (All Rights Reserved-Unauthorized Use Prohibited)

SLOPE STABILITY ANALYSIS SYSTEM

Modified Bishop, Simplified Janbu, or GLE Method of Slices.
 (Includes Spencer & Morgenstern-Price Type Analysis)
 Including Pier/Pile, Reinforcement, Soil Nail, Tieback,
 Nonlinear Undrained Shear Strength, Curved Phi Envelope,
 Anisotropic Soil, Fiber-Reinforced Soil, Boundary Loads, Water
 Surfaces, Pseudo-Static & Newmark Earthquake, and Applied Forces.

Analysis Run Date: 5/9/2013
 Time of Run: 07:05AM
 Run By: Username
 Input Data Filename: Z:\2010\10132-01 South Shores Church - Dana Point\Engineerin
 g\2013_05\Alternate Design\ff'_lcp.
 Output Filename: Z:\2010\10132-01 South Shores Church - Dana Point\Engineerin
 g\2013_05\Alternate Design\ff'_lcp.OUT
 Unit System: English
 Plotted Output Filename: Z:\2010\10132-01 South Shores Church - Dana Point\Engineerin
 g\2013_05\Alternate Design\ff'_lcp.PLT
 PROBLEM DESCRIPTION: F-F' / Alternate Design / Circular
 Search / Pseudostatic

BOUNDARY COORDINATES

22 Top Boundaries
 44 Total Boundaries

Boundary No.	X-Left (ft)	Y-Left (ft)	X-Right (ft)	Y-Right (ft)	Soil Type Below Bnd
1	0.00	193.00	100.00	195.00	1
2	100.00	195.00	109.00	203.00	2
3	109.00	203.00	130.00	211.00	2
4	130.00	211.00	140.00	212.00	2
5	140.00	212.00	146.00	216.00	2
6	146.00	216.00	199.00	237.00	2
7	199.00	237.00	205.00	237.00	2
8	205.00	237.00	216.00	243.00	2
9	216.00	243.00	228.00	249.00	3
10	228.00	249.00	230.00	250.00	4
11	230.00	250.00	235.00	252.00	4
12	235.00	252.00	250.00	254.00	4
13	250.00	254.00	250.10	260.00	1
14	250.10	260.00	275.00	260.00	1
15	275.00	260.00	330.00	260.00	4
16	330.00	260.00	380.00	260.00	4
17	380.00	260.00	395.00	270.00	5
18	395.00	270.00	439.00	271.00	4
19	439.00	271.00	439.10	266.00	4
20	439.10	266.00	533.00	266.00	4
21	533.00	266.00	572.00	275.00	4
22	572.00	275.00	600.00	273.00	4
23	250.00	254.00	275.00	260.00	4
24	0.00	151.00	80.00	185.00	3
25	80.00	185.00	170.00	213.00	3
26	170.00	213.00	183.00	220.00	3
27	183.00	220.00	216.00	243.00	3
28	0.00	149.00	80.00	183.00	4
29	80.00	183.00	170.00	211.00	4
30	170.00	211.00	183.00	218.00	4
31	183.00	218.00	216.00	241.00	4
32	216.00	241.00	228.00	249.00	4
33	0.00	122.00	76.00	153.00	5
34	76.00	153.00	250.00	211.00	5
35	250.00	211.00	329.00	260.00	5
36	0.00	120.00	76.00	151.00	6
37	76.00	151.00	250.00	209.00	6

38	250.00	209.00	332.00	260.00	4
39	250.00	209.00	280.00	217.00	6
40	280.00	217.00	292.00	219.00	6
41	292.00	219.00	320.00	223.00	6
42	320.00	223.00	360.00	225.00	6
43	360.00	225.00	400.00	226.00	6
44	400.00	226.00	600.00	230.00	6

Default Y-Origin = 0.00(ft)
 Default X-Plus Value = 0.00(ft)
 Default Y-Plus Value = 0.00(ft)

ISOTROPIC SOIL PARAMETERS

6 Type(s) of Soil

Soil Type No.	Total Unit Wt. (pcf)	Saturated Unit Wt. (pcf)	Cohesion Intercept (psf)	Friction Angle (deg)	Pore Pressure Param. (psf)	Pressure Constant (psf)	Piez. Surface No.
1	130.0	130.0	200.0	29.0	0.00	0.0	0
2	130.0	130.0	270.0	19.0	0.00	0.0	0
3	130.0	130.0	270.0	19.0	0.00	0.0	0
4	130.0	130.0	500.0	30.0	0.00	0.0	0
5	130.0	130.0	270.0	19.0	0.00	0.0	0
6	130.0	130.0	1500.0	39.0	0.00	0.0	0

BOUNDARY LOAD(S)

2 Load(s) Specified

Load No.	X-Left (ft)	X-Right (ft)	Intensity (psf)	Deflection (deg)
1	275.00	372.00	500.0	0.0
2	439.10	524.00	500.0	0.0

NOTE - Intensity Is Specified As A Uniformly Distributed Force Acting On A Horizontally Projected Surface.

Specified Peak Ground Acceleration Coefficient (A) = 0.300(g)

Specified Horizontal Earthquake Coefficient (kh) = 0.150(g)

Specified Vertical Earthquake Coefficient (kv) = 0.000(g)

Specified Seismic Pore-Pressure Factor = 0.000

A Critical Failure Surface Searching Method, Using A Random Technique For Generating Circular Surfaces, Has Been Specified. 5000 Trial Surfaces Have Been Generated.

500 Surface(s) Initiate(s) From Each Of 10 Points Equally Spaced Along The Ground Surface Between X = 60.00(ft)

and X = 140.00(ft)

Each Surface Terminates Between X = 220.00(ft)

and X = 350.00(ft)

Unless Further Limitations Were Imposed, The Minimum Elevation At Which A Surface Extends Is Y = 0.00(ft)

10.00(ft) Line Segments Define Each Trial Failure Surface.

Following Are Displayed The Ten Most Critical Of The Trial

Failure Surfaces Evaluated. They Are

Ordered - Most Critical First.

* * Safety Factors Are Calculated By The Modified Bishop Method * *

Total Number of Trial Surfaces Attempted = 5000

Number of Trial Surfaces With Valid FS = 5000

Statistical Data On All Valid FS Values:

FS Max = 4.005 FS Min = 1.388 FS Ave = 2.588

Standard Deviation = 0.684 Coefficient of Variation = 26.44 %

Failure Surface Specified By 29 Coordinate Points

Point No.	X-Surf (ft)	Y-Surf (ft)
1	68.889	194.378
2	78.648	192.196
3	88.479	190.365
4	98.369	188.887
5	108.306	187.763
6	118.276	186.996
7	128.268	186.585
8	138.268	186.531
9	148.263	186.836
10	158.241	187.497
11	168.189	188.515

12	178.095	189.887
13	187.945	191.613
14	197.726	193.690
15	207.428	196.116
16	217.036	198.887
17	226.540	201.999
18	235.925	205.449
19	245.182	209.233
20	254.297	213.345
21	263.260	217.781
22	272.058	222.534
23	280.681	227.599
24	289.117	232.968
25	297.355	238.636
26	305.386	244.595
27	313.199	250.837
28	320.783	257.354
29	323.648	260.000

Circle Center At X = 134.760 ; Y = 466.161 ; and Radius = 279.652

Factor of Safety

*** 1.388 ***

Slice No.	Width (ft)	Weight (lbs)	Water Force		Tie Force		Earthquake Force		Surcharge Load (lbs)
			Top (lbs)	Bot (lbs)	Norm (lbs)	Tan (lbs)	Hor (lbs)	Ver (lbs)	
1	9.8	1507.5	0.0	0.0	0.	0.	226.1	0.0	0.0
2	9.8	4332.9	0.0	0.0	0.	0.	649.9	0.0	0.0
3	5.9	3776.8	0.0	0.0	0.	0.	566.5	0.0	0.0
4	4.0	2963.2	0.0	0.0	0.	0.	444.5	0.0	0.0
5	0.4	322.4	0.0	0.0	0.	0.	48.4	0.0	0.0
6	1.2	989.7	0.0	0.0	0.	0.	148.5	0.0	0.0
7	8.3	11292.6	0.0	0.0	0.	0.	1693.9	0.0	0.0
8	0.7	1349.6	0.0	0.0	0.	0.	202.4	0.0	0.0
9	9.3	21000.1	0.0	0.0	0.	0.	3150.0	0.0	0.0
10	10.0	28117.2	0.0	0.0	0.	0.	4217.6	0.0	0.0
11	1.7	5424.6	0.0	0.0	0.	0.	813.7	0.0	0.0
12	8.3	26719.6	0.0	0.0	0.	0.	4007.9	0.0	0.0
13	1.7	5710.1	0.0	0.0	0.	0.	856.5	0.0	0.0
14	6.0	21313.2	0.0	0.0	0.	0.	3197.0	0.0	0.0
15	2.3	8722.2	0.0	0.0	0.	0.	1308.3	0.0	0.0
16	10.0	41129.2	0.0	0.0	0.	0.	6169.4	0.0	0.0
17	9.9	45024.9	0.0	0.0	0.	0.	6753.7	0.0	0.0
18	1.8	8594.5	0.0	0.0	0.	0.	1289.2	0.0	0.0
19	8.1	39762.8	0.0	0.0	0.	0.	5964.4	0.0	0.0
20	4.9	25107.3	0.0	0.0	0.	0.	3766.1	0.0	0.0
21	4.9	26007.0	0.0	0.0	0.	0.	3901.0	0.0	0.0
22	9.8	53289.1	0.0	0.0	0.	0.	7993.4	0.0	0.0
23	1.3	7102.5	0.0	0.0	0.	0.	1065.4	0.0	0.0
24	0.1	590.8	0.0	0.0	0.	0.	88.6	0.0	0.0
25	5.9	32357.3	0.0	0.0	0.	0.	4853.6	0.0	0.0
26	2.4	13208.4	0.0	0.0	0.	0.	1981.3	0.0	0.0
27	8.6	48264.3	0.0	0.0	0.	0.	7239.6	0.0	0.0
28	1.0	5997.9	0.0	0.0	0.	0.	899.7	0.0	0.0
29	9.5	56151.3	0.0	0.0	0.	0.	8422.7	0.0	0.0
30	1.5	8803.2	0.0	0.0	0.	0.	1320.5	0.0	0.0
31	2.0	12115.1	0.0	0.0	0.	0.	1817.3	0.0	0.0
32	5.0	30426.3	0.0	0.0	0.	0.	4564.0	0.0	0.0
33	0.9	5628.4	0.0	0.0	0.	0.	844.3	0.0	0.0
34	9.3	54631.2	0.0	0.0	0.	0.	8194.7	0.0	0.0
35	1.4	7794.8	0.0	0.0	0.	0.	1169.2	0.0	0.0
36	3.5	19362.6	0.0	0.0	0.	0.	2904.4	0.0	0.0
37	0.1	592.5	0.0	0.0	0.	0.	88.9	0.0	0.0
38	2.3	14389.5	0.0	0.0	0.	0.	2158.4	0.0	0.0
39	1.9	11584.6	0.0	0.0	0.	0.	1737.7	0.0	0.0
40	9.0	51774.5	0.0	0.0	0.	0.	7766.2	0.0	0.0
41	6.5	34357.4	0.0	0.0	0.	0.	5153.6	0.0	0.0

42	2.3	11213.2	0.0	0.0	0.	0.	1682.0	0.0	0.0
43	2.9	13998.6	0.0	0.0	0.	0.	2099.8	0.0	0.0
44	5.7	25160.1	0.0	0.0	0.	0.	3774.0	0.0	2840.3
45	8.4	32589.8	0.0	0.0	0.	0.	4888.5	0.0	4218.0
46	5.5	17859.5	0.0	0.0	0.	0.	2678.9	0.0	2730.9
47	2.8	8057.1	0.0	0.0	0.	0.	1208.6	0.0	1388.4
48	8.0	19193.5	0.0	0.0	0.	0.	2879.0	0.0	4015.4
49	4.2	7565.1	0.0	0.0	0.	0.	1134.8	0.0	2122.4
50	3.6	4911.1	0.0	0.0	0.	0.	736.7	0.0	1783.9
51	7.6	5821.6	0.0	0.0	0.	0.	873.2	0.0	3792.2
52	2.9	492.7	0.0	0.0	0.	0.	73.9	0.0	1432.5

Failure Surface Specified By 28 Coordinate Points

Point No.	X-Surf (ft)	Y-Surf (ft)
1	77.778	194.556
2	87.564	192.500
3	97.420	190.809
4	107.333	189.487
5	117.287	188.535
6	127.270	187.955
7	137.268	187.746
8	147.267	187.910
9	157.252	188.446
10	167.211	189.353
11	177.129	190.630
12	186.993	192.276
13	196.788	194.288
14	206.502	196.663
15	216.121	199.399
16	225.631	202.490
17	235.019	205.934
18	244.273	209.724
19	253.379	213.857
20	262.325	218.325
21	271.099	223.124
22	279.687	228.246
23	288.079	233.684
24	296.263	239.431
25	304.227	245.479
26	311.961	251.819
27	319.453	258.442
28	321.088	260.000

Circle Center At X = 137.874 ; Y = 456.143 ; and Radius = 268.401

Factor of Safety

*** 1.435 ***

Failure Surface Specified By 28 Coordinate Points

Point No.	X-Surf (ft)	Y-Surf (ft)
1	68.889	194.378
2	78.529	191.718
3	88.272	189.468
4	98.102	187.630
5	108.000	186.209
6	117.950	185.207
7	127.933	184.625
8	137.932	184.465
9	147.928	184.727
10	157.905	185.410
11	167.844	186.513
12	177.728	188.035
13	187.538	189.972
14	197.258	192.321
15	206.871	195.079
16	216.358	198.239
17	225.704	201.797
18	234.891	205.745
19	243.904	210.078

20	252.726	214.787
21	261.341	219.864
22	269.735	225.300
23	277.891	231.085
24	285.797	237.209
25	293.437	243.661
26	300.798	250.430
27	307.867	257.503
28	310.161	260.000

Circle Center At X = 136.725 ; Y = 421.316 ; and Radius = 236.860

Factor of Safety
 *** 1.444 ***

Failure Surface Specified By 27 Coordinate Points

Point No.	X-Surf (ft)	Y-Surf (ft)
1	68.889	194.378
2	78.440	191.415
3	88.119	188.904
4	97.906	186.849
5	107.778	185.256
6	117.715	184.128
7	127.693	183.467
8	137.691	183.275
9	147.687	183.553
10	157.659	184.299
11	167.585	185.512
12	177.444	187.190
13	187.212	189.328
14	196.870	191.922
15	206.395	194.967
16	215.767	198.454
17	224.965	202.378
18	233.969	206.729
19	242.759	211.498
20	251.315	216.674
21	259.619	222.246
22	267.653	228.201
23	275.398	234.526
24	282.838	241.208
25	289.956	248.231
26	296.737	255.581
27	300.446	260.000

Circle Center At X = 136.779 ; Y = 396.356 ; and Radius = 213.083

Factor of Safety
 *** 1.449 ***

Failure Surface Specified By 15 Coordinate Points

Point No.	X-Surf (ft)	Y-Surf (ft)
1	104.444	198.951
2	114.420	199.655
3	124.347	200.856
4	134.202	202.552
5	143.961	204.737
6	153.598	207.407
7	163.089	210.554
8	172.412	214.172
9	181.543	218.250
10	190.459	222.779
11	199.137	227.747
12	207.557	233.143
13	215.696	238.952
14	223.536	245.160
15	227.808	248.904

Circle Center At X = 95.331 ; Y = 399.007 ; and Radius = 200.264

Factor of Safety
 *** 1.450 ***

Failure Surface Specified By 28 Coordinate Points

Point No.	X-Surf (ft)	Y-Surf (ft)
1	68.889	194.378
2	78.571	191.875
3	88.344	189.760
4	98.195	188.038
5	108.107	186.711
6	118.063	185.781
7	128.049	185.249
8	138.048	185.117
9	148.045	185.384
10	158.022	186.050
11	167.966	187.115
12	177.858	188.576
13	187.685	190.431
14	197.429	192.677
15	207.076	195.311
16	216.610	198.328
17	226.016	201.723
18	235.279	205.491
19	244.384	209.627
20	253.316	214.123
21	262.061	218.972
22	270.606	224.167
23	278.937	229.699
24	287.040	235.560
25	294.902	241.739
26	302.511	248.228
27	309.854	255.015
28	314.833	260.000

Circle Center At X = 136.357 ; Y = 435.211 ; and Radius = 250.105

Factor of Safety
 *** 1.450 ***

Failure Surface Specified By 29 Coordinate Points

Point No.	X-Surf (ft)	Y-Surf (ft)
1	68.889	194.378
2	78.684	192.362
3	88.541	190.678
4	98.449	189.328
5	108.398	188.314
6	118.375	187.636
7	128.369	187.296
8	138.369	187.293
9	148.363	187.628
10	158.341	188.301
11	168.290	189.310
12	178.199	190.655
13	188.057	192.333
14	197.853	194.344
15	207.575	196.684
16	217.213	199.352
17	226.755	202.343
18	236.190	205.655
19	245.509	209.284
20	254.699	213.226
21	263.751	217.476
22	272.654	222.029
23	281.399	226.880
24	289.974	232.024
25	298.371	237.455
26	306.580	243.166
27	314.591	249.151
28	322.395	255.404
29	327.751	260.000

Circle Center At X = 133.446 ; Y = 483.256 ; and Radius = 296.004

Factor of Safety

*** 1.452 ***
 Failure Surface Specified By 24 Coordinate Points

Point No.	X-Surf (ft)	Y-Surf (ft)
1	86.667	194.733
2	96.123	191.480
3	105.754	188.790
4	115.527	186.672
5	125.408	185.135
6	135.363	184.184
7	145.356	183.822
8	155.354	184.050
9	165.320	184.868
10	175.221	186.272
11	185.022	188.258
12	194.689	190.818
13	204.187	193.945
14	213.485	197.626
15	222.549	201.850
16	231.349	206.601
17	239.852	211.863
18	248.031	217.618
19	255.855	223.845
20	263.299	230.522
21	270.335	237.628
22	276.940	245.136
23	283.091	253.021
24	287.901	260.000

Circle Center At X = 146.490 ; Y = 353.145 ; and Radius = 169.331
 Factor of Safety

*** 1.452 ***
 Failure Surface Specified By 25 Coordinate Points

Point No.	X-Surf (ft)	Y-Surf (ft)
1	104.444	198.951
2	114.146	196.524
3	123.952	194.564
4	133.840	193.076
5	143.789	192.063
6	153.774	191.526
7	163.774	191.468
8	173.765	191.889
9	183.725	192.787
10	193.630	194.160
11	203.458	196.006
12	213.187	198.320
13	222.794	201.097
14	232.257	204.330
15	241.554	208.013
16	250.664	212.136
17	259.567	216.690
18	268.242	221.665
19	276.669	227.049
20	284.828	232.830
21	292.702	238.995
22	300.272	245.530
23	307.520	252.419
24	314.430	259.647
25	314.737	260.000

Circle Center At X = 159.985 ; Y = 400.385 ; and Radius = 208.951
 Factor of Safety

*** 1.454 ***
 Failure Surface Specified By 15 Coordinate Points

Point No.	X-Surf (ft)	Y-Surf (ft)
1	104.444	198.951
2	114.437	199.331

3	124.394	200.262
4	134.284	201.742
5	144.077	203.766
6	153.743	206.328
7	163.253	209.420
8	172.577	213.033
9	181.688	217.155
10	190.557	221.775
11	199.158	226.877
12	207.463	232.447
13	215.448	238.467
14	223.088	244.918
15	226.750	248.375

Circle Center At X = 102.569 ; Y = 379.884 ; and Radius = 180.944
Factor of Safety
*** 1.466 ***
**** END OF GSTABL7 OUTPUT ****

***Appendix D Subsection:
Risk Assessment of Unimproved Areas***

B-B' / Alt Design / Search Along Clay / Outside PL (Block)

z:\2010\10132-01 south shores church - dana point\engineering\2013_01\bb'1_1.pl2 Run By: Username 1/15/2013 08:36AM

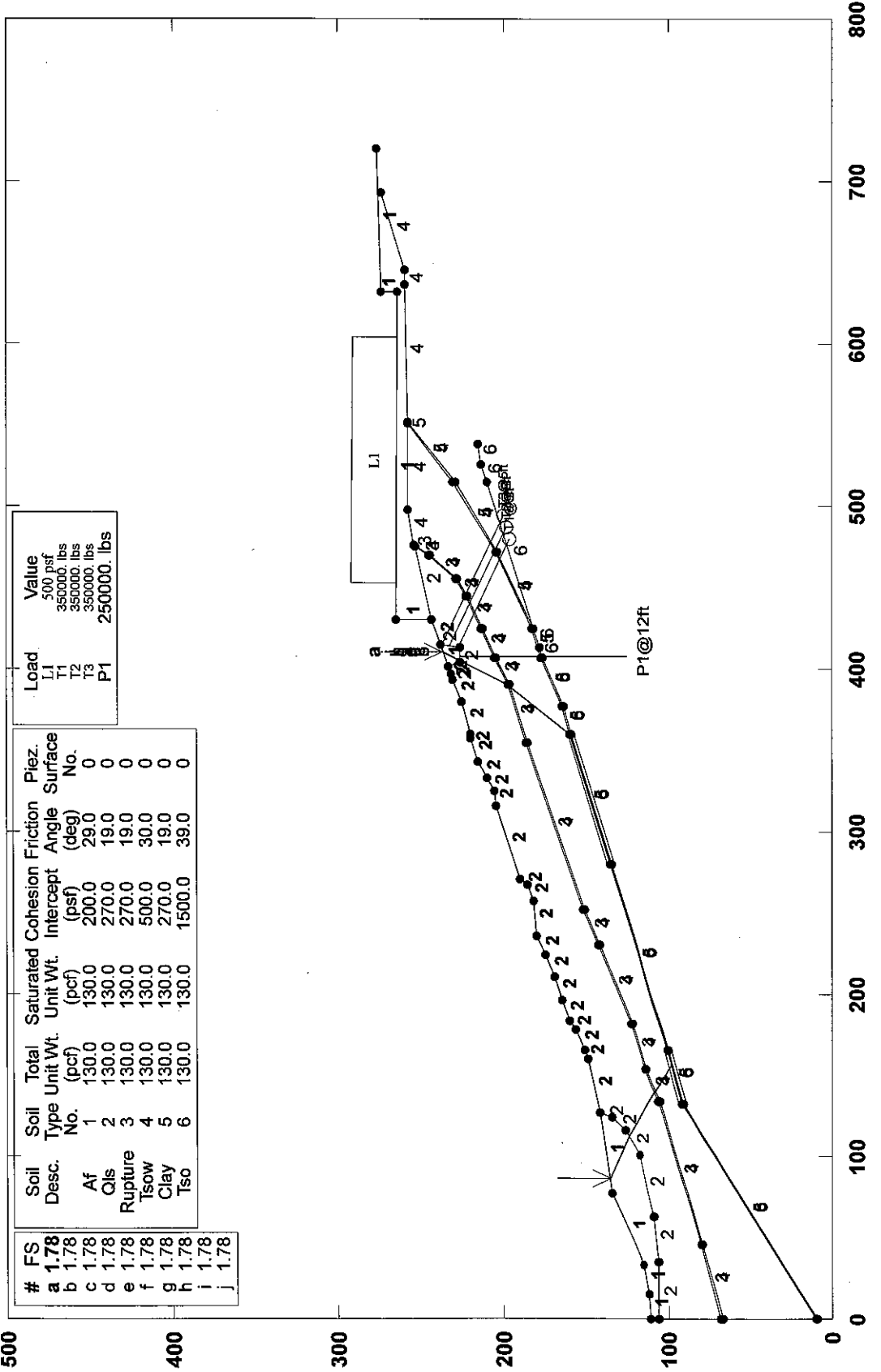

Load	Value
L1	500 psf
T1	350000. lbs
T2	350000. lbs
T3	350000. lbs
P1	2500000. lbs

Soil Desc.	Soil Type No.	Total Unit Wt. (pcf)	Saturated Unit Wt. (pcf)	Cohesion Intercept (psf)	Friction Angle (deg)	Piez. Surface No.
Af	1	130.0	130.0	200.0	29.0	0
Qls	2	130.0	130.0	270.0	19.0	0
Rupture	3	130.0	130.0	270.0	19.0	0
Tsow	4	130.0	130.0	500.0	30.0	0
Clay	5	130.0	130.0	270.0	19.0	0
Tso	6	130.0	130.0	1500.0	39.0	0

#	FS
a	1.78
b	1.78
c	1.78
d	1.78
e	1.78
f	1.78
g	1.78
h	1.78
i	1.78
j	1.78

GSTABL7 v.2 FSmin=1.78

Safety Factors Are Calculated By The Simplified Janbu Method for the case of c & phi both > 0

*** GSTABL7 ***

** GSTABL7 by Dr. Garry H. Gregory, Ph.D., P.E., D.GE **
 ** Original Version 1.0, January 1996; Current Ver. 2.005.2, Jan. 2011 **
 (All Rights Reserved-Unauthorized Use Prohibited)

SLOPE STABILITY ANALYSIS SYSTEM

Modified Bishop, Simplified Janbu, or GLE Method of Slices.
 (Includes Spencer & Morgenstern-Price Type Analysis)
 Including Pier/Pile, Reinforcement, Soil Nail, Tieback,
 Nonlinear Undrained Shear Strength, Curved Phi Envelope,
 Anisotropic Soil, Fiber-Reinforced Soil, Boundary Loads, Water
 Surfaces, Pseudo-Static & Newmark Earthquake, and Applied Forces.

Analysis Run Date: 1/15/2013
 Time of Run: 08:36AM
 Run By: Username
 Input Data Filename: Z:\2010\10132-01 South Shores Church - Dana Point\Engineerin
 g\2013_01\bb'1_1.
 Output Filename: Z:\2010\10132-01 South Shores Church - Dana Point\Engineerin
 g\2013_01\bb'1_1.OUT
 Unit System: English
 Plotted Output Filename: Z:\2010\10132-01 South Shores Church - Dana Point\Engineerin
 g\2013_01\bb'1_1.PLT
 PROBLEM DESCRIPTION: B-B' / Alt Design / Search Along Clay /
 Outside PL (Block)

BOUNDARY COORDINATES

31 Top Boundaries
 100 Total Boundaries

Boundary No.	X-Left (ft)	Y-Left (ft)	X-Right (ft)	Y-Right (ft)	Soil Type Below Bnd
1	0.00	111.00	15.00	112.00	1
2	15.00	112.00	33.00	115.00	1
3	33.00	115.00	77.00	135.00	1
4	77.00	135.00	127.00	142.00	1
5	127.00	142.00	160.00	149.00	2
6	160.00	149.00	166.00	151.00	2
7	166.00	151.00	178.00	157.00	2
8	178.00	157.00	184.00	160.00	2
9	184.00	160.00	196.00	165.00	2
10	196.00	165.00	211.00	169.00	2
11	211.00	169.00	224.00	175.00	2
12	224.00	175.00	236.00	180.00	2
13	236.00	180.00	257.00	182.00	2
14	257.00	182.00	267.00	185.00	2
15	267.00	185.00	271.00	190.00	2
16	271.00	190.00	316.00	204.00	2
17	316.00	204.00	325.00	205.00	2
18	325.00	205.00	333.00	210.00	2
19	333.00	210.00	343.00	215.00	2
20	343.00	215.00	357.00	220.00	2
21	357.00	220.00	360.00	220.00	2
22	360.00	220.00	380.00	225.00	2
23	380.00	225.00	393.00	230.00	2
24	393.00	230.00	397.00	231.00	2
25	397.00	231.00	401.00	233.00	2
26	401.00	233.00	415.00	238.00	1
27	415.00	238.00	430.00	243.00	2
28	430.00	243.00	430.10	265.00	1
29	430.10	265.00	632.00	264.00	1
30	632.00	264.00	632.10	274.00	1
31	632.10	274.00	720.00	276.00	1
32	0.00	106.00	35.00	106.00	2
33	35.00	106.00	63.00	109.00	2
34	63.00	109.00	101.00	118.00	2
35	101.00	118.00	116.00	127.00	2
36	116.00	127.00	124.00	135.00	2
37	124.00	135.00	127.00	142.00	2

38	401.00	233.00	404.00	226.00	2
39	404.00	226.00	413.00	226.00	2
40	413.00	226.00	415.00	238.00	2
41	430.00	243.00	475.00	253.00	2
42	475.00	253.00	476.00	253.50	3
43	476.00	253.50	498.00	257.00	4
44	498.00	257.00	551.00	257.00	4
45	551.00	257.00	552.00	257.00	5
46	552.00	257.00	636.00	259.00	4
47	636.00	259.00	645.00	259.00	4
48	645.00	259.00	693.00	274.00	4
49	0.00	68.00	46.00	80.00	3
50	46.00	80.00	134.00	106.00	3
51	134.00	106.00	154.00	114.00	3
52	154.00	114.00	182.00	123.00	3
53	182.00	123.00	230.00	143.00	3
54	230.00	143.00	252.00	152.00	3
55	252.00	152.00	355.00	186.00	3
56	355.00	186.00	391.00	197.00	3
57	391.00	197.00	407.20	205.00	3
58	407.20	205.00	425.20	213.30	3
59	425.20	213.30	445.00	222.00	3
60	445.00	222.00	455.00	229.00	3
61	455.00	229.00	470.00	245.00	3
62	470.00	245.00	475.00	253.00	3
63	0.00	67.00	46.00	79.00	4
64	46.00	79.00	134.00	105.00	4
65	134.00	105.00	154.00	113.00	4
66	154.00	113.00	182.00	122.00	4
67	182.00	122.00	230.00	142.00	4
68	230.00	142.00	252.00	151.00	4
69	252.00	151.00	355.00	185.00	4
70	355.00	185.00	391.00	196.00	4
71	391.00	196.00	407.10	204.00	4
72	407.10	204.00	425.10	212.30	4
73	425.10	212.30	445.00	221.00	4
74	445.00	221.00	455.00	228.00	4
75	455.00	228.00	470.00	244.00	4
76	470.00	244.00	476.00	253.50	4
77	0.00	10.00	132.00	92.00	5
78	132.00	92.00	166.00	101.00	5
79	166.00	101.00	280.00	136.00	5
80	280.00	136.00	360.00	160.00	5
81	360.00	160.00	377.00	165.00	5
82	377.00	165.00	407.00	177.00	5
83	407.00	177.00	425.00	183.00	5
84	425.00	183.00	472.00	204.00	5
85	472.00	204.00	515.00	230.00	5
86	515.00	230.00	551.00	257.00	5
87	0.00	9.00	132.00	91.00	6
88	132.00	91.00	166.00	100.00	6
89	166.00	100.00	280.00	135.00	6
90	280.00	135.00	360.00	159.00	6
91	360.00	159.00	377.00	164.00	6
92	377.00	164.00	407.00	176.00	6
93	407.00	176.00	413.00	178.00	6
94	413.00	178.00	425.00	182.00	6
95	425.00	182.00	472.00	203.00	4
96	472.00	203.00	515.00	229.00	4
97	515.00	229.00	552.00	257.00	4
98	425.00	182.00	515.00	210.00	6
99	515.00	210.00	526.00	213.00	6
100	526.00	213.00	538.00	215.00	6

Default Y-Origin = 0.00(ft)
 Default X-Plus Value = 0.00(ft)
 Default Y-Plus Value = 0.00(ft)
 ISOTROPIC SOIL PARAMETERS

6 Type(s) of Soil

Soil Type No.	Total Unit Wt. (pcf)	Saturated Unit Wt. (pcf)	Cohesion Intercept (psf)	Friction Angle (deg)	Pore Pressure Param. (psf)	Pressure Constant (psf)	Piez. Surface No.
1	130.0	130.0	200.0	29.0	0.00	0.0	0
2	130.0	130.0	270.0	19.0	0.00	0.0	0
3	130.0	130.0	270.0	19.0	0.00	0.0	0
4	130.0	130.0	500.0	30.0	0.00	0.0	0
5	130.0	130.0	270.0	19.0	0.00	0.0	0
6	130.0	130.0	1500.0	39.0	0.00	0.0	0

BOUNDARY LOAD(S)

1 Load(s) Specified

Load No.	X-Left (ft)	X-Right (ft)	Intensity (psf)	Deflection (deg)
1	453.00	604.00	500.0	0.0

NOTE - Intensity Is Specified As A Uniformly Distributed Force Acting On A Horizontally Projected Surface.

TIEBACK LOAD(S)

3 Tieback Load(s) Specified

Tieback No.	X-Pos (ft)	Y-Pos (ft)	Load (lbs)	Spacing (ft)	Inclination (deg)	Length (ft)	Force Method
1	413.17	227.00	350000.0	5.0	25.00	73.0	2
2	414.00	232.00	350000.0	5.0	25.00	80.0	2
3	414.83	237.00	350000.0	5.0	25.00	87.0	2

NOTE - An Equivalent Line Load Is Calculated For Each Row Of Tiebacks Assuming A Uniform Distribution Of Load Horizontally Between Individual Tiebacks. Force Method 1 Considers Only Tangential Tieback Forces. Force Method 2 Considers Both Tangential and Normal Tieback Forces. Force Method 3 Considers Only Normal Tieback Forces. Force Method 4 Limits Normal and Tangential Tieback-Force Distribution to 1.5 Times the Tieback Inclination, or to 30 Degrees Below (Left of) the Tieback-Failure Surface Intersection, Whichever is Greater.

PIER/PILE LOAD(S)

1 Pier/Pile Load(s) Specified

Pier/Pile No.	X-Pos (ft)	Y-Pos (ft)	Load (lbs)	Spacing (ft)	Inclination (deg)	Length (ft)
1	407.40	226.00	250000.0	12.0	90.00	100.0

NOTE - An Equivalent Line Load Is Calculated For Each Row Of Piers/Piles Assuming A Uniform Distribution Of Load Horizontally Between Individual Piers/Piles.

Janbus Empirical Coef is being used for the case of c & ϕ both > 0
 A Critical Failure Surface Searching Method, Using A Random Technique For Generating Sliding Block Surfaces, Has Been Specified.

8000 Trial Surfaces Have Been Generated.

2 Boxes Specified For Generation Of Central Block Base Length Of Line Segments For Active And Passive Portions Of Sliding Block Is 50.0

Box No.	X-Left (ft)	Y-Left (ft)	X-Right (ft)	Y-Right (ft)	Height (ft)
1	132.00	91.50	166.00	100.50	4.00
2	280.00	135.50	360.00	159.50	4.00

WARNING! The factor of safety calculation did not converge in 20 iterations.

The Trial Failure Surface In Question Is Defined

By The Following 7 Coordinate Points

Point No.	X-Surf (ft)	Y-Surf (ft)
1	119.70	140.98
2	127.25	134.03
3	164.46	100.64
4	350.72	156.02
5	383.33	193.92
6	417.65	230.28
7	417.76	238.92

Factor of Safety for the Preceding Surface is Between -1.133 and -1.141

WARNING! The factor of safety calculation did not converge in 20 iterations.

The Trial Failure Surface In Question Is Defined

By The Following 7 Coordinate Points

Point No.	X-Surf (ft)	Y-Surf (ft)
1	119.70	140.98
2	127.25	134.03
3	164.46	100.64
4	350.72	156.02
5	383.33	193.92
6	417.65	230.28
7	417.76	238.92

Factor of Safety for the Preceding Surface is Between-1.133 and-1.141
WARNING! The factor of safety calculation did not converge in 20 iterations.
The Trial Failure Surface In Question Is Defined

By The Following 7 Coordinate Points

Point No.	X-Surf (ft)	Y-Surf (ft)
1	119.70	140.98
2	127.25	134.03
3	164.46	100.64
4	350.72	156.02
5	383.33	193.92
6	417.65	230.28
7	417.76	238.92

Factor of Safety for the Preceding Surface is Between-1.133 and-1.141
WARNING! The factor of safety calculation did not converge in 20 iterations.
The Trial Failure Surface In Question Is Defined

By The Following 7 Coordinate Points

Point No.	X-Surf (ft)	Y-Surf (ft)
1	119.70	140.98
2	127.25	134.03
3	164.46	100.64
4	350.72	156.02
5	383.33	193.92
6	417.65	230.28
7	417.76	238.92

Factor of Safety for the Preceding Surface is Between-1.133 and-1.141
WARNING! The factor of safety calculation did not converge in 20 iterations.
The Trial Failure Surface In Question Is Defined

By The Following 7 Coordinate Points

Point No.	X-Surf (ft)	Y-Surf (ft)
1	119.70	140.98
2	127.25	134.03
3	164.46	100.64
4	350.72	156.02
5	383.33	193.92
6	417.65	230.28
7	417.76	238.92

Factor of Safety for the Preceding Surface is Between-1.133 and-1.141
WARNING! The factor of safety calculation did not converge in 20 iterations.
The Trial Failure Surface In Question Is Defined

By The Following 7 Coordinate Points

Point No.	X-Surf (ft)	Y-Surf (ft)
1	119.70	140.98
2	127.25	134.03
3	164.46	100.64
4	350.72	156.02
5	383.33	193.92
6	417.65	230.28
7	417.76	238.92

Factor of Safety for the Preceding Surface is Between-1.133 and-1.141
WARNING! The factor of safety calculation did not converge in 20 iterations.
The Trial Failure Surface In Question Is Defined

By The Following 7 Coordinate Points

Point	X-Surf	Y-Surf
-------	--------	--------

No.	(ft)	(ft)
1	119.70	140.98
2	127.25	134.03
3	164.46	100.64
4	350.72	156.02
5	383.33	193.92
6	417.65	230.28
7	417.76	238.92

Factor of Safety for the Preceding Surface is Between-1.133 and-1.141
 WARNING! The factor of safety calculation did not converge in 20 iterations.
 The Trial Failure Surface In Question Is Defined
 By The Following 7 Coordinate Points

Point No.	X-Surf (ft)	Y-Surf (ft)
1	119.70	140.98
2	127.25	134.03
3	164.46	100.64
4	350.72	156.02
5	383.33	193.92
6	417.65	230.28
7	417.76	238.92

Factor of Safety for the Preceding Surface is Between-1.133 and-1.141
 WARNING! The factor of safety calculation did not converge in 20 iterations.
 The Trial Failure Surface In Question Is Defined
 By The Following 7 Coordinate Points

Point No.	X-Surf (ft)	Y-Surf (ft)
1	119.70	140.98
2	127.25	134.03
3	164.46	100.64
4	350.72	156.02
5	383.33	193.92
6	417.65	230.28
7	417.76	238.92

Factor of Safety for the Preceding Surface is Between-1.133 and-1.141
 WARNING! The factor of safety calculation did not converge in 20 iterations.
 The Trial Failure Surface In Question Is Defined
 By The Following 7 Coordinate Points

Point No.	X-Surf (ft)	Y-Surf (ft)
1	119.70	140.98
2	127.25	134.03
3	164.46	100.64
4	350.72	156.02
5	383.33	193.92
6	417.65	230.28
7	417.76	238.92

Factor of Safety for the Preceding Surface is Between-1.133 and-1.141
 WARNING! The factor of safety calculation did not converge in 20 iterations.
 The Trial Failure Surface In Question Is Defined
 By The Following 7 Coordinate Points

Point No.	X-Surf (ft)	Y-Surf (ft)
1	119.70	140.98
2	127.25	134.03
3	164.46	100.64
4	350.72	156.02
5	383.33	193.92
6	417.65	230.28
7	417.76	238.92

Factor of Safety for the Preceding Surface is Between-1.133 and-1.141
 WARNING! The factor of safety calculation did not converge in 20 iterations.
 The Trial Failure Surface In Question Is Defined
 By The Following 7 Coordinate Points

Point No.	X-Surf (ft)	Y-Surf (ft)
1	119.70	140.98

2	127.25	134.03
3	164.46	100.64
4	350.72	156.02
5	383.33	193.92
6	417.65	230.28
7	417.76	238.92

Factor of Safety for the Preceding Surface is Between-1.133 and-1.141
 WARNING! The factor of safety calculation did not converge in 20 iterations.
 The Trial Failure Surface In Question Is Defined
 By The Following 7 Coordinate Points

Point No.	X-Surf (ft)	Y-Surf (ft)
1	119.70	140.98
2	127.25	134.03
3	164.46	100.64
4	350.72	156.02
5	383.33	193.92
6	417.65	230.28
7	417.76	238.92

Factor of Safety for the Preceding Surface is Between-1.133 and-1.141
 WARNING! The factor of safety calculation did not converge in 20 iterations.
 The Trial Failure Surface In Question Is Defined
 By The Following 7 Coordinate Points

Point No.	X-Surf (ft)	Y-Surf (ft)
1	119.70	140.98
2	127.25	134.03
3	164.46	100.64
4	350.72	156.02
5	383.33	193.92
6	417.65	230.28
7	417.76	238.92

Factor of Safety for the Preceding Surface is Between-1.133 and-1.141
 WARNING! The factor of safety calculation did not converge in 20 iterations.
 The Trial Failure Surface In Question Is Defined
 By The Following 7 Coordinate Points

Point No.	X-Surf (ft)	Y-Surf (ft)
1	119.70	140.98
2	127.25	134.03
3	164.46	100.64
4	350.72	156.02
5	383.33	193.92
6	417.65	230.28
7	417.76	238.92

Factor of Safety for the Preceding Surface is Between-1.133 and-1.141
 WARNING! The factor of safety calculation did not converge in 20 iterations.
 The Trial Failure Surface In Question Is Defined
 By The Following 7 Coordinate Points

Point No.	X-Surf (ft)	Y-Surf (ft)
1	119.70	140.98
2	127.25	134.03
3	164.46	100.64
4	350.72	156.02
5	383.33	193.92
6	417.65	230.28
7	417.76	238.92

Factor of Safety for the Preceding Surface is Between-1.133 and-1.141
 Following Are Displayed The Ten Most Critical Of The Trial

Failure Surfaces Evaluated. They Are
 Ordered - Most Critical First.

* * Safety Factors Are Calculated By The Simplified Janbu Method * *

Total Number of Trial Surfaces Attempted = 8000

WARNING! The Factor of Safety Calculation for one or More Trial Surfaces
 Did Not Converge in 20 Iterations.

Number of Trial Surfaces with Non-Converged FS = 16

Number of Trial Failure Surfaces is Greater Than 5000.
 Statistical Data on FS Values are Not Generated.
 To Generate Stastical Data, Reduce Number of Trial
 Failure Surfaces to 5000 or less.

Failure Surface Specified By 6 Coordinate Points

Point No.	X-Surf (ft)	Y-Surf (ft)
1	86.583	136.342
2	113.794	124.053
3	156.543	98.120
4	359.272	159.332
5	390.477	198.400
6	410.349	236.339

Factor of Safety
 *** 1.775 ***

Slice No.	Width (ft)	Weight (lbs)	Individual data on the		44 slices		Earthquake		
			Water Force Top (lbs)	Water Force Bot (lbs)	Tie Force Norm (lbs)	Tie Force Tan (lbs)	Force Hor (lbs)	Force Ver (lbs)	Surcharge Load (lbs)
1	25.7	25333.9	0.0	0.0	0.	0.	0.0	0.0	0.0
2	1.5	3140.0	0.0	0.0	0.	0.	0.0	0.0	0.0
3	2.2	4851.9	0.0	0.0	0.	0.	0.0	0.0	0.0
4	8.0	21561.0	0.0	0.0	0.	0.	0.0	0.0	0.0
5	3.0	9686.9	0.0	0.0	0.	0.	0.0	0.0	0.0
6	12.8	51710.7	0.0	0.0	0.	0.	0.0	0.0	0.0
7	1.0	4753.7	0.0	0.0	0.	0.	0.0	0.0	0.0
8	13.2	73446.2	0.0	0.0	0.	0.	0.0	0.0	0.0
9	2.1	13424.0	0.0	0.0	0.	0.	0.0	0.0	0.0
10	0.4	2812.1	0.0	0.0	0.	0.	0.0	0.0	0.0
11	3.5	22464.7	0.0	0.0	0.	0.	0.0	0.0	0.0
12	6.0	38946.1	0.0	0.0	0.	0.	0.0	0.0	0.0
13	12.0	79892.9	0.0	0.0	0.	0.	0.0	0.0	0.0
14	4.0	27454.9	0.0	0.0	0.	0.	0.0	0.0	0.0
15	2.0	13881.9	0.0	0.0	0.	0.	0.0	0.0	0.0
16	12.0	84674.3	0.0	0.0	0.	0.	0.0	0.0	0.0
17	15.0	106669.2	0.0	0.0	0.	0.	0.0	0.0	0.0
18	13.0	93752.7	0.0	0.0	0.	0.	0.0	0.0	0.0
19	6.0	44348.1	0.0	0.0	0.	0.	0.0	0.0	0.0
20	6.0	44885.0	0.0	0.0	0.	0.	0.0	0.0	0.0
21	16.0	116969.6	0.0	0.0	0.	0.	0.0	0.0	0.0
22	5.0	35142.2	0.0	0.0	0.	0.	0.0	0.0	0.0
23	10.0	69600.0	0.0	0.0	0.	0.	0.0	0.0	0.0
24	4.0	28820.9	0.0	0.0	0.	0.	0.0	0.0	0.0
25	9.0	67113.8	0.0	0.0	0.	0.	0.0	0.0	0.0
26	36.0	269420.7	0.0	0.0	0.	0.	0.0	0.0	0.0
27	9.0	66543.5	0.0	0.0	0.	0.	0.0	0.0	0.0
28	8.0	59600.6	0.0	0.0	0.	0.	0.0	0.0	0.0
29	10.0	77468.0	0.0	0.0	0.	0.	0.0	0.0	0.0
30	12.0	95023.2	0.0	0.0	0.	0.	0.0	0.0	0.0
31	2.0	15937.7	0.0	0.0	0.	0.	0.0	0.0	0.0
32	2.3	18023.8	0.0	0.0	0.	0.	0.0	0.0	0.0
33	0.5	3705.5	0.0	0.0	0.	0.	0.0	0.0	0.0
34	0.3	1989.4	0.0	0.0	0.	0.	0.0	0.0	0.0
35	20.0	129317.0	0.0	0.0	0.	0.	0.0	0.0	0.0
36	7.8	36729.5	0.0	0.0	0.	0.	0.0	0.0	0.0
37	1.1	4466.7	0.0	0.0	0.	0.	0.0	0.0	0.0
38	1.6	6713.2	0.0	0.0	0.	0.	0.0	0.0	0.0
39	2.5	9414.0	0.0	0.0	0.	0.	0.0	0.0	0.0
40	4.0	12202.3	0.0	0.0	0.	0.	0.0	0.0	0.0
41	4.0	9011.1	0.0	0.0	0.	0.	0.0	0.0	0.0
42	3.0	4751.2	0.0	0.0	0.	0.	0.0	0.0	0.0
43	0.9	1108.3	0.0	0.0	0.	0.	0.0	0.0	0.0
44	5.4	2958.4	0.0	0.0	0.	0.	0.0	0.0	0.0

Failure Surface Specified By 6 Coordinate Points

Point No.	X-Surf (ft)	Y-Surf (ft)
-----------	-------------	-------------

1	86.583	136.342
2	113.794	124.053
3	156.543	98.120
4	359.272	159.332
5	390.477	198.400
6	410.349	236.339

Factor of Safety
 *** 1.775 ***

Failure Surface Specified By 6 Coordinate Points

Point No.	X-Surf (ft)	Y-Surf (ft)
1	86.583	136.342
2	113.794	124.053
3	156.543	98.120
4	359.272	159.332
5	390.477	198.400
6	410.349	236.339

Factor of Safety
 *** 1.775 ***

Failure Surface Specified By 6 Coordinate Points

Point No.	X-Surf (ft)	Y-Surf (ft)
1	86.583	136.342
2	113.794	124.053
3	156.543	98.120
4	359.272	159.332
5	390.477	198.400
6	410.349	236.339

Factor of Safety
 *** 1.775 ***

Failure Surface Specified By 6 Coordinate Points

Point No.	X-Surf (ft)	Y-Surf (ft)
1	86.583	136.342
2	113.794	124.053
3	156.543	98.120
4	359.272	159.332
5	390.477	198.400
6	410.349	236.339

Factor of Safety
 *** 1.775 ***

Failure Surface Specified By 6 Coordinate Points

Point No.	X-Surf (ft)	Y-Surf (ft)
1	86.583	136.342
2	113.794	124.053
3	156.543	98.120
4	359.272	159.332
5	390.477	198.400
6	410.349	236.339

Factor of Safety
 *** 1.775 ***

Failure Surface Specified By 6 Coordinate Points

Point No.	X-Surf (ft)	Y-Surf (ft)
1	86.583	136.342
2	113.794	124.053
3	156.543	98.120
4	359.272	159.332
5	390.477	198.400
6	410.349	236.339

Factor of Safety
 *** 1.775 ***

Failure Surface Specified By 6 Coordinate Points

Point No.	X-Surf (ft)	Y-Surf (ft)
1	86.583	136.342

2	113.794	124.053
3	156.543	98.120
4	359.272	159.332
5	390.477	198.400
6	410.349	236.339

Factor of Safety
*** 1.775 ***

Failure Surface Specified By 6 Coordinate Points

Point No.	X-Surf (ft)	Y-Surf (ft)
1	86.583	136.342
2	113.794	124.053
3	156.543	98.120
4	359.272	159.332
5	390.477	198.400
6	410.349	236.339

Factor of Safety
*** 1.775 ***

Failure Surface Specified By 6 Coordinate Points

Point No.	X-Surf (ft)	Y-Surf (ft)
1	86.583	136.342
2	113.794	124.053
3	156.543	98.120
4	359.272	159.332
5	390.477	198.400
6	410.349	236.339

Factor of Safety
*** 1.775 ***

**** END OF GSTABL7 OUTPUT ****

B-B' / Alt Design / Search Along Rupture/ Outside PL (Block)

z:\2010\10132-01 south shores church - dana point\engineering\2013_01\bb'1_2.pl2 Run By: Username 1/15/2013 09:01AM

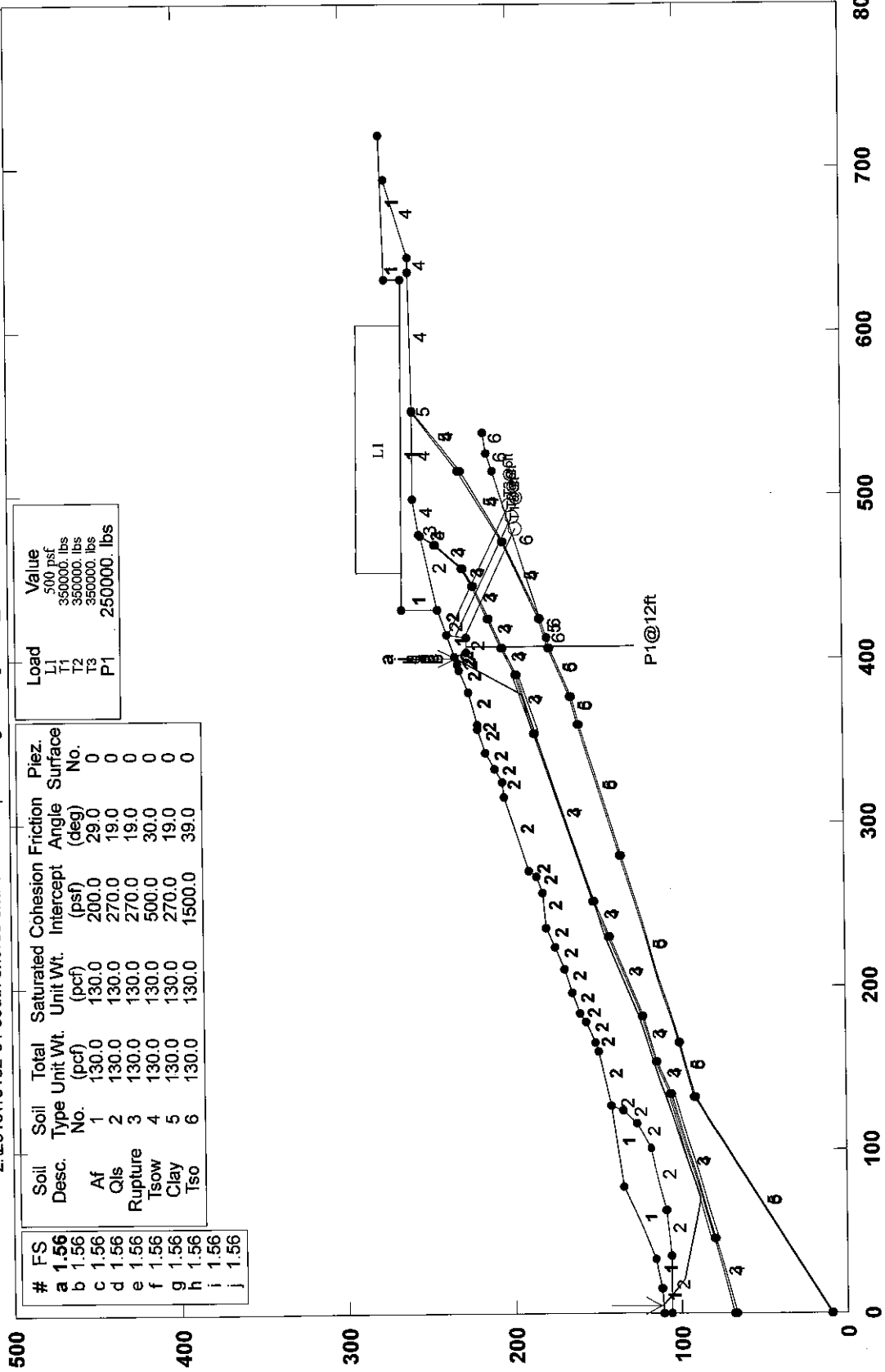

GSTABL7 v.2 FSmin=1.56

Safety Factors Are Calculated By The Simplified Janbu Method for the case of c & phi both > 0

*** GSTABL7 ***

** GSTABL7 by Dr. Garry H. Gregory, Ph.D., P.E., D.GE **

** Original Version 1.0, January 1996; Current Ver. 2.005.2, Jan. 2011 **
 (All Rights Reserved-Unauthorized Use Prohibited)

SLOPE STABILITY ANALYSIS SYSTEM

Modified Bishop, Simplified Janbu, or GLE Method of Slices.
 (Includes Spencer & Morgenstern-Price Type Analysis)
 Including Pier/Pile, Reinforcement, Soil Nail, Tieback,
 Nonlinear Undrained Shear Strength, Curved Phi Envelope,
 Anisotropic Soil, Fiber-Reinforced Soil, Boundary Loads, Water
 Surfaces, Pseudo-Static & Newmark Earthquake, and Applied Forces.

Analysis Run Date: 1/15/2013
 Time of Run: 09:01AM
 Run By: Username
 Input Data Filename: Z:\2010\10132-01 South Shores Church - Dana Point\Engineerin
 g\2013_01\bb'1_2.
 Output Filename: Z:\2010\10132-01 South Shores Church - Dana Point\Engineerin
 g\2013_01\bb'1_2.OUT
 Unit System: English
 Plotted Output Filename: Z:\2010\10132-01 South Shores Church - Dana Point\Engineerin
 g\2013_01\bb'1_2.PLT
 PROBLEM DESCRIPTION: B-B' / Alt Design / Search Along Rupture
 / Outside PL (Block)

BOUNDARY COORDINATES

31 Top Boundaries
 100 Total Boundaries

Boundary No.	X-Left (ft)	Y-Left (ft)	X-Right (ft)	Y-Right (ft)	Soil Type Below Bnd
1	0.00	111.00	15.00	112.00	1
2	15.00	112.00	33.00	115.00	1
3	33.00	115.00	77.00	135.00	1
4	77.00	135.00	127.00	142.00	1
5	127.00	142.00	160.00	149.00	2
6	160.00	149.00	166.00	151.00	2
7	166.00	151.00	178.00	157.00	2
8	178.00	157.00	184.00	160.00	2
9	184.00	160.00	196.00	165.00	2
10	196.00	165.00	211.00	169.00	2
11	211.00	169.00	224.00	175.00	2
12	224.00	175.00	236.00	180.00	2
13	236.00	180.00	257.00	182.00	2
14	257.00	182.00	267.00	185.00	2
15	267.00	185.00	271.00	190.00	2
16	271.00	190.00	316.00	204.00	2
17	316.00	204.00	325.00	205.00	2
18	325.00	205.00	333.00	210.00	2
19	333.00	210.00	343.00	215.00	2
20	343.00	215.00	357.00	220.00	2
21	357.00	220.00	360.00	220.00	2
22	360.00	220.00	380.00	225.00	2
23	380.00	225.00	393.00	230.00	2
24	393.00	230.00	397.00	231.00	2
25	397.00	231.00	401.00	233.00	2
26	401.00	233.00	415.00	238.00	1
27	415.00	238.00	430.00	243.00	2
28	430.00	243.00	430.10	265.00	1
29	430.10	265.00	632.00	264.00	1
30	632.00	264.00	632.10	274.00	1
31	632.10	274.00	720.00	276.00	1
32	0.00	106.00	35.00	106.00	2
33	35.00	106.00	63.00	109.00	2
34	63.00	109.00	101.00	118.00	2
35	101.00	118.00	116.00	127.00	2
36	116.00	127.00	124.00	135.00	2
37	124.00	135.00	127.00	142.00	2

38	401.00	233.00	404.00	226.00	2
39	404.00	226.00	413.00	226.00	2
40	413.00	226.00	415.00	238.00	2
41	430.00	243.00	475.00	253.00	2
42	475.00	253.00	476.00	253.50	3
43	476.00	253.50	498.00	257.00	4
44	498.00	257.00	551.00	257.00	4
45	551.00	257.00	552.00	257.00	5
46	552.00	257.00	636.00	259.00	4
47	636.00	259.00	645.00	259.00	4
48	645.00	259.00	693.00	274.00	4
49	0.00	68.00	46.00	80.00	3
50	46.00	80.00	134.00	106.00	3
51	134.00	106.00	154.00	114.00	3
52	154.00	114.00	182.00	123.00	3
53	182.00	123.00	230.00	143.00	3
54	230.00	143.00	252.00	152.00	3
55	252.00	152.00	355.00	186.00	3
56	355.00	186.00	391.00	197.00	3
57	391.00	197.00	407.20	205.00	3
58	407.20	205.00	425.20	213.30	3
59	425.20	213.30	445.00	222.00	3
60	445.00	222.00	455.00	229.00	3
61	455.00	229.00	470.00	245.00	3
62	470.00	245.00	475.00	253.00	3
63	0.00	67.00	46.00	79.00	4
64	46.00	79.00	134.00	105.00	4
65	134.00	105.00	154.00	113.00	4
66	154.00	113.00	182.00	122.00	4
67	182.00	122.00	230.00	142.00	4
68	230.00	142.00	252.00	151.00	4
69	252.00	151.00	355.00	185.00	4
70	355.00	185.00	391.00	196.00	4
71	391.00	196.00	407.10	204.00	4
72	407.10	204.00	425.10	212.30	4
73	425.10	212.30	445.00	221.00	4
74	445.00	221.00	455.00	228.00	4
75	455.00	228.00	470.00	244.00	4
76	470.00	244.00	476.00	253.50	4
77	0.00	10.00	132.00	92.00	5
78	132.00	92.00	166.00	101.00	5
79	166.00	101.00	280.00	136.00	5
80	280.00	136.00	360.00	160.00	5
81	360.00	160.00	377.00	165.00	5
82	377.00	165.00	407.00	177.00	5
83	407.00	177.00	425.00	183.00	5
84	425.00	183.00	472.00	204.00	5
85	472.00	204.00	515.00	230.00	5
86	515.00	230.00	551.00	257.00	5
87	0.00	9.00	132.00	91.00	6
88	132.00	91.00	166.00	100.00	6
89	166.00	100.00	280.00	135.00	6
90	280.00	135.00	360.00	159.00	6
91	360.00	159.00	377.00	164.00	6
92	377.00	164.00	407.00	176.00	6
93	407.00	176.00	413.00	178.00	6
94	413.00	178.00	425.00	182.00	6
95	425.00	182.00	472.00	203.00	4
96	472.00	203.00	515.00	229.00	4
97	515.00	229.00	552.00	257.00	4
98	425.00	182.00	515.00	210.00	6
99	515.00	210.00	526.00	213.00	6
100	526.00	213.00	538.00	215.00	6

Default Y-Origin = 0.00(ft)
 Default X-Plus Value = 0.00(ft)
 Default Y-Plus Value = 0.00(ft)
 ISOTROPIC SOIL PARAMETERS

6 Type(s) of Soil

Soil Type No.	Total Unit Wt. (pcf)	Saturated Unit Wt. (pcf)	Cohesion Intercept (psf)	Friction Angle (deg)	Pore Pressure Param. (psf)	Pressure Constant (psf)	Piez. Surface No.
1	130.0	130.0	200.0	29.0	0.00	0.0	0
2	130.0	130.0	270.0	19.0	0.00	0.0	0
3	130.0	130.0	270.0	19.0	0.00	0.0	0
4	130.0	130.0	500.0	30.0	0.00	0.0	0
5	130.0	130.0	270.0	19.0	0.00	0.0	0
6	130.0	130.0	1500.0	39.0	0.00	0.0	0

BOUNDARY LOAD(S)

1 Load(s) Specified

Load No.	X-Left (ft)	X-Right (ft)	Intensity (psf)	Deflection (deg)
1	453.00	604.00	500.0	0.0

NOTE - Intensity Is Specified As A Uniformly Distributed Force Acting On A Horizontally Projected Surface.

TIEBACK LOAD(S)

3 Tieback Load(s) Specified

Tieback No.	X-Pos (ft)	Y-Pos (ft)	Load (lbs)	Spacing (ft)	Inclination (deg)	Length (ft)	Force Method
1	413.17	227.00	350000.0	5.0	25.00	73.0	2
2	414.00	232.00	350000.0	5.0	25.00	80.0	2
3	414.83	237.00	350000.0	5.0	25.00	87.0	2

NOTE - An Equivalent Line Load Is Calculated For Each Row Of Tiebacks Assuming A Uniform Distribution Of Load Horizontally Between Individual Tiebacks. Force Method 1 Considers Only Tangential Tieback Forces. Force Method 2 Considers Both Tangential and Normal Tieback Forces. Force Method 3 Considers Only Normal Tieback Forces. Force Method 4 Limits Normal and Tangential Tieback-Force Distribution to 1.5 Times the Tieback Inclination, or to 30 Degrees Below (Left of) the Tieback-Failure Surface Intersection, Whichever is Greater.

PIER/PILE LOAD(S)

1 Pier/Pile Load(s) Specified

Pier/Pile No.	X-Pos (ft)	Y-Pos (ft)	Load (lbs)	Spacing (ft)	Inclination (deg)	Length (ft)
1	407.40	226.00	250000.0	12.0	90.00	100.0

NOTE - An Equivalent Line Load Is Calculated For Each Row Of Piers/Piles Assuming A Uniform Distribution Of Load Horizontally Between Individual Piers/Piles.

Janbus Empirical Coef is being used for the case of c & ϕ both > 0
 A Critical Failure Surface Searching Method, Using A Random Technique For Generating Sliding Block Surfaces, Has Been Specified.

8000 Trial Surfaces Have Been Generated.

7 Boxes Specified For Generation Of Central Block Base

Length Of Line Segments For Active And Passive Portions Of Sliding Block Is 50.0

Box No.	X-Left (ft)	Y-Left (ft)	X-Right (ft)	Y-Right (ft)	Height (ft)
1	46.00	79.50	134.00	105.50	4.00
2	153.00	113.50	155.00	113.50	4.00
3	181.00	122.50	183.00	123.50	4.00
4	229.00	142.50	231.00	142.50	4.00
5	251.00	151.50	253.00	151.50	4.00
6	354.00	185.50	356.00	185.50	4.00
7	356.10	185.50	391.00	197.00	4.00

The Factor Of Safety For The Trial Failure Surface Defined By The Coordinates Listed Below Is Misleading.
 Failure Surface Defined By 11 Coordinate Points

Point No.	X-Surf (ft)	Y-Surf (ft)
1	46.27	121.03
2	68.09	120.13
3	112.60	97.33
4	153.13	112.26
5	182.54	123.07

6	229.45	141.62
7	252.04	153.12
8	355.00	184.66
9	382.41	192.80
10	416.37	229.49
11	416.98	238.66

Factor Of Safety For The Preceding Specified Surface = -1.636
 The Factor Of Safety For The Trial Failure Surface Defined
 By The Coordinates Listed Below Is Misleading.
 Failure Surface Defined By 11 Coordinate Points

Point No.	X-Surf (ft)	Y-Surf (ft)
1	46.27	121.03
2	68.09	120.13
3	112.60	97.33
4	153.13	112.26
5	182.54	123.07
6	229.45	141.62
7	252.04	153.12
8	355.00	184.66
9	382.41	192.80
10	416.37	229.49
11	416.98	238.66

Factor Of Safety For The Preceding Specified Surface = -1.636
 The Factor Of Safety For The Trial Failure Surface Defined
 By The Coordinates Listed Below Is Misleading.
 Failure Surface Defined By 11 Coordinate Points

Point No.	X-Surf (ft)	Y-Surf (ft)
1	46.27	121.03
2	68.09	120.13
3	112.60	97.33
4	153.13	112.26
5	182.54	123.07
6	229.45	141.62
7	252.04	153.12
8	355.00	184.66
9	382.41	192.80
10	416.37	229.49
11	416.98	238.66

Factor Of Safety For The Preceding Specified Surface = -1.636
 The Factor Of Safety For The Trial Failure Surface Defined
 By The Coordinates Listed Below Is Misleading.
 Failure Surface Defined By 11 Coordinate Points

Point No.	X-Surf (ft)	Y-Surf (ft)
1	46.27	121.03
2	68.09	120.13
3	112.60	97.33
4	153.13	112.26
5	182.54	123.07
6	229.45	141.62
7	252.04	153.12
8	355.00	184.66
9	382.41	192.80
10	416.37	229.49
11	416.98	238.66

Factor Of Safety For The Preceding Specified Surface = -1.636
 The Factor Of Safety For The Trial Failure Surface Defined
 By The Coordinates Listed Below Is Misleading.
 Failure Surface Defined By 11 Coordinate Points

Point No.	X-Surf (ft)	Y-Surf (ft)
1	46.27	121.03
2	68.09	120.13
3	112.60	97.33
4	153.13	112.26

5	182.54	123.07
6	229.45	141.62
7	252.04	153.12
8	355.00	184.66
9	382.41	192.80
10	416.37	229.49
11	416.98	238.66

Factor Of Safety For The Preceding Specified Surface = -1.636
 The Factor Of Safety For The Trial Failure Surface Defined
 By The Coordinates Listed Below Is Misleading.

Failure Surface Defined By 11 Coordinate Points

Point No.	X-Surf (ft)	Y-Surf (ft)
1	46.27	121.03
2	68.09	120.13
3	112.60	97.33
4	153.13	112.26
5	182.54	123.07
6	229.45	141.62
7	252.04	153.12
8	355.00	184.66
9	382.41	192.80
10	416.37	229.49
11	416.98	238.66

Factor Of Safety For The Preceding Specified Surface = -1.636
 The Factor Of Safety For The Trial Failure Surface Defined
 By The Coordinates Listed Below Is Misleading.

Failure Surface Defined By 11 Coordinate Points

Point No.	X-Surf (ft)	Y-Surf (ft)
1	46.27	121.03
2	68.09	120.13
3	112.60	97.33
4	153.13	112.26
5	182.54	123.07
6	229.45	141.62
7	252.04	153.12
8	355.00	184.66
9	382.41	192.80
10	416.37	229.49
11	416.98	238.66

Factor Of Safety For The Preceding Specified Surface = -1.636
 The Factor Of Safety For The Trial Failure Surface Defined
 By The Coordinates Listed Below Is Misleading.

Failure Surface Defined By 11 Coordinate Points

Point No.	X-Surf (ft)	Y-Surf (ft)
1	46.27	121.03
2	68.09	120.13
3	112.60	97.33
4	153.13	112.26
5	182.54	123.07
6	229.45	141.62
7	252.04	153.12
8	355.00	184.66
9	382.41	192.80
10	416.37	229.49
11	416.98	238.66

Factor Of Safety For The Preceding Specified Surface = -1.636
 The Factor Of Safety For The Trial Failure Surface Defined
 By The Coordinates Listed Below Is Misleading.

Failure Surface Defined By 11 Coordinate Points

Point No.	X-Surf (ft)	Y-Surf (ft)
1	46.27	121.03
2	68.09	120.13
3	112.60	97.33

4	153.13	112.26
5	182.54	123.07
6	229.45	141.62
7	252.04	153.12
8	355.00	184.66
9	382.41	192.80
10	416.37	229.49
11	416.98	238.66

Factor Of Safety For The Preceding Specified Surface = -1.636

The Factor Of Safety For The Trial Failure Surface Defined

By The Coordinates Listed Below Is Misleading.

Failure Surface Defined By 11 Coordinate Points

Point No.	X-Surf (ft)	Y-Surf (ft)
1	46.27	121.03
2	68.09	120.13
3	112.60	97.33
4	153.13	112.26
5	182.54	123.07
6	229.45	141.62
7	252.04	153.12
8	355.00	184.66
9	382.41	192.80
10	416.37	229.49
11	416.98	238.66

Factor Of Safety For The Preceding Specified Surface = -1.636

The Factor Of Safety For The Trial Failure Surface Defined

By The Coordinates Listed Below Is Misleading.

Failure Surface Defined By 11 Coordinate Points

Point No.	X-Surf (ft)	Y-Surf (ft)
1	46.27	121.03
2	68.09	120.13
3	112.60	97.33
4	153.13	112.26
5	182.54	123.07
6	229.45	141.62
7	252.04	153.12
8	355.00	184.66
9	382.41	192.80
10	416.37	229.49
11	416.98	238.66

Factor Of Safety For The Preceding Specified Surface = -1.636

The Factor Of Safety For The Trial Failure Surface Defined

By The Coordinates Listed Below Is Misleading.

Failure Surface Defined By 11 Coordinate Points

Point No.	X-Surf (ft)	Y-Surf (ft)
1	46.27	121.03
2	68.09	120.13
3	112.60	97.33
4	153.13	112.26
5	182.54	123.07
6	229.45	141.62
7	252.04	153.12
8	355.00	184.66
9	382.41	192.80
10	416.37	229.49
11	416.98	238.66

Factor Of Safety For The Preceding Specified Surface = -1.636

The Factor Of Safety For The Trial Failure Surface Defined

By The Coordinates Listed Below Is Misleading.

Failure Surface Defined By 11 Coordinate Points

Point No.	X-Surf (ft)	Y-Surf (ft)
1	46.27	121.03
2	68.09	120.13

3	112.60	97.33
4	153.13	112.26
5	182.54	123.07
6	229.45	141.62
7	252.04	153.12
8	355.00	184.66
9	382.41	192.80
10	416.37	229.49
11	416.98	238.66

Factor Of Safety For The Preceding Specified Surface = -1.636
 The Factor Of Safety For The Trial Failure Surface Defined
 By The Coordinates Listed Below Is Misleading.
 Failure Surface Defined By 11 Coordinate Points

Point No.	X-Surf (ft)	Y-Surf (ft)
1	46.27	121.03
2	68.09	120.13
3	112.60	97.33
4	153.13	112.26
5	182.54	123.07
6	229.45	141.62
7	252.04	153.12
8	355.00	184.66
9	382.41	192.80
10	416.37	229.49
11	416.98	238.66

Factor Of Safety For The Preceding Specified Surface = -1.636
 The Factor Of Safety For The Trial Failure Surface Defined
 By The Coordinates Listed Below Is Misleading.
 Failure Surface Defined By 11 Coordinate Points

Point No.	X-Surf (ft)	Y-Surf (ft)
1	46.27	121.03
2	68.09	120.13
3	112.60	97.33
4	153.13	112.26
5	182.54	123.07
6	229.45	141.62
7	252.04	153.12
8	355.00	184.66
9	382.41	192.80
10	416.37	229.49
11	416.98	238.66

Factor Of Safety For The Preceding Specified Surface = -1.636
 The Factor Of Safety For The Trial Failure Surface Defined
 By The Coordinates Listed Below Is Misleading.
 Failure Surface Defined By 11 Coordinate Points

Point No.	X-Surf (ft)	Y-Surf (ft)
1	46.27	121.03
2	68.09	120.13
3	112.60	97.33
4	153.13	112.26
5	182.54	123.07
6	229.45	141.62
7	252.04	153.12
8	355.00	184.66
9	382.41	192.80
10	416.37	229.49
11	416.98	238.66

Factor Of Safety For The Preceding Specified Surface = -1.636
 The Factor Of Safety For The Trial Failure Surface Defined
 By The Coordinates Listed Below Is Misleading.
 Failure Surface Defined By 11 Coordinate Points

SOME LINES SKIPPED #####
 Following Are Displayed The Ten Most Critical Of The Trial
 Failure Surfaces Evaluated. They Are

Ordered - Most Critical First.

* * Safety Factors Are Calculated By The Simplified Janbu Method * *

Total Number of Trial Surfaces Attempted = 8000

Number of Trial Surfaces with Misleading FS = 34

Number of Trial Failure Surfaces is Greater Than 5000.

Statistical Data on FS Values are Not Generated.

To Generate Stastical Data, Reduce Number of Trial

Failure Surfaces to 5000 or less.

Failure Surface Specified By 10 Coordinate Points

Point No.	X-Surf (ft)	Y-Surf (ft)
1	4.347	111.290
2	21.128	97.831
3	70.143	87.954
4	153.317	115.491
5	182.141	124.653
6	230.706	144.471
7	251.201	151.532
8	354.313	185.139
9	377.570	192.243
10	400.117	232.558

Factor of Safety

*** 1.559 ***

Individual data on the 43 slices

Slice No.	Width (ft)	Weight (lbs)	Water Force		Tie Force		Earthquake Force		Surcharge Load (lbs)
			Top (lbs)	Bot (lbs)	Norm (lbs)	Tan (lbs)	Hor (lbs)	Ver (lbs)	
1	6.6	2456.2	0.0	0.0	0.	0.	0.0	0.0	0.0
2	4.1	3951.8	0.0	0.0	0.	0.	0.0	0.0	0.0
3	6.1	9737.3	0.0	0.0	0.	0.	0.0	0.0	0.0
4	11.9	26817.3	0.0	0.0	0.	0.	0.0	0.0	0.0
5	2.0	5256.6	0.0	0.0	0.	0.	0.0	0.0	0.0
6	28.0	109412.0	0.0	0.0	0.	0.	0.0	0.0	0.0
7	7.1	38616.6	0.0	0.0	0.	0.	0.0	0.0	0.0
8	6.9	39535.7	0.0	0.0	0.	0.	0.0	0.0	0.0
9	24.0	132546.2	0.0	0.0	0.	0.	0.0	0.0	0.0
10	15.0	75575.8	0.0	0.0	0.	0.	0.0	0.0	0.0
11	8.0	38021.9	0.0	0.0	0.	0.	0.0	0.0	0.0
12	3.0	13848.3	0.0	0.0	0.	0.	0.0	0.0	0.0
13	26.3	115147.9	0.0	0.0	0.	0.	0.0	0.0	0.0
14	6.7	27572.7	0.0	0.0	0.	0.	0.0	0.0	0.0
15	6.0	24516.3	0.0	0.0	0.	0.	0.0	0.0	0.0
16	12.0	50809.7	0.0	0.0	0.	0.	0.0	0.0	0.0
17	4.1	18322.7	0.0	0.0	0.	0.	0.0	0.0	0.0
18	1.9	8340.5	0.0	0.0	0.	0.	0.0	0.0	0.0
19	12.0	54037.9	0.0	0.0	0.	0.	0.0	0.0	0.0
20	15.0	65579.8	0.0	0.0	0.	0.	0.0	0.0	0.0
21	13.0	55630.8	0.0	0.0	0.	0.	0.0	0.0	0.0
22	6.7	29024.7	0.0	0.0	0.	0.	0.0	0.0	0.0
23	5.3	23065.1	0.0	0.0	0.	0.	0.0	0.0	0.0
24	13.0	54283.9	0.0	0.0	0.	0.	0.0	0.0	0.0
25	2.2	8577.4	0.0	0.0	0.	0.	0.0	0.0	0.0
26	0.8	3097.6	0.0	0.0	0.	0.	0.0	0.0	0.0
27	5.0	18950.6	0.0	0.0	0.	0.	0.0	0.0	0.0
28	10.0	36982.8	0.0	0.0	0.	0.	0.0	0.0	0.0
29	4.0	15686.7	0.0	0.0	0.	0.	0.0	0.0	0.0
30	45.0	185336.8	0.0	0.0	0.	0.	0.0	0.0	0.0
31	9.0	35546.2	0.0	0.0	0.	0.	0.0	0.0	0.0
32	8.0	31835.4	0.0	0.0	0.	0.	0.0	0.0	0.0
33	10.0	42480.9	0.0	0.0	0.	0.	0.0	0.0	0.0
34	11.3	49599.9	0.0	0.0	0.	0.	0.0	0.0	0.0
35	0.7	3027.7	0.0	0.0	0.	0.	0.0	0.0	0.0
36	2.0	8836.9	0.0	0.0	0.	0.	0.0	0.0	0.0
37	3.0	13096.9	0.0	0.0	0.	0.	0.0	0.0	0.0
38	17.6	74542.9	0.0	0.0	0.	0.	0.0	0.0	0.0
39	0.4	1821.7	0.0	0.0	0.	0.	0.0	0.0	0.0

40	2.0	7745.6	0.0	0.0	0.	0.	0.0	0.0	0.0
41	13.0	32598.2	0.0	0.0	0.	0.	0.0	0.0	0.0
42	4.0	3687.1	0.0	0.0	0.	0.	0.0	0.0	0.0
43	3.1	813.3	0.0	0.0	0.	0.	0.0	0.0	0.0

Failure Surface Specified By 10 Coordinate Points

Point No.	X-Surf (ft)	Y-Surf (ft)
1	4.347	111.290
2	21.128	97.831
3	70.143	87.954
4	153.317	115.491
5	182.141	124.653
6	230.706	144.471
7	251.201	151.532
8	354.313	185.139
9	377.570	192.243
10	400.117	232.558

Factor of Safety
 *** 1.559 ***

Failure Surface Specified By 10 Coordinate Points

Point No.	X-Surf (ft)	Y-Surf (ft)
1	4.347	111.290
2	21.128	97.831
3	70.143	87.954
4	153.317	115.491
5	182.141	124.653
6	230.706	144.471
7	251.201	151.532
8	354.313	185.139
9	377.570	192.243
10	400.117	232.558

Factor of Safety
 *** 1.559 ***

Failure Surface Specified By 10 Coordinate Points

Point No.	X-Surf (ft)	Y-Surf (ft)
1	4.347	111.290
2	21.128	97.831
3	70.143	87.954
4	153.317	115.491
5	182.141	124.653
6	230.706	144.471
7	251.201	151.532
8	354.313	185.139
9	377.570	192.243
10	400.117	232.558

Factor of Safety
 *** 1.559 ***

Failure Surface Specified By 10 Coordinate Points

Point No.	X-Surf (ft)	Y-Surf (ft)
1	4.347	111.290
2	21.128	97.831
3	70.143	87.954
4	153.317	115.491
5	182.141	124.653
6	230.706	144.471
7	251.201	151.532
8	354.313	185.139
9	377.570	192.243
10	400.117	232.558

Factor of Safety
 *** 1.559 ***

Failure Surface Specified By 10 Coordinate Points

Point No.	X-Surf (ft)	Y-Surf (ft)
-----------	-------------	-------------

1	4.347	111.290
2	21.128	97.831
3	70.143	87.954
4	153.317	115.491
5	182.141	124.653
6	230.706	144.471
7	251.201	151.532
8	354.313	185.139
9	377.570	192.243
10	400.117	232.558

Factor of Safety
 *** 1.559 ***

Failure Surface Specified By 10 Coordinate Points

Point No.	X-Surf (ft)	Y-Surf (ft)
1	4.347	111.290
2	21.128	97.831
3	70.143	87.954
4	153.317	115.491
5	182.141	124.653
6	230.706	144.471
7	251.201	151.532
8	354.313	185.139
9	377.570	192.243
10	400.117	232.558

Factor of Safety
 *** 1.559 ***

Failure Surface Specified By 10 Coordinate Points

Point No.	X-Surf (ft)	Y-Surf (ft)
1	4.347	111.290
2	21.128	97.831
3	70.143	87.954
4	153.317	115.491
5	182.141	124.653
6	230.706	144.471
7	251.201	151.532
8	354.313	185.139
9	377.570	192.243
10	400.117	232.558

Factor of Safety
 *** 1.559 ***

Failure Surface Specified By 10 Coordinate Points

Point No.	X-Surf (ft)	Y-Surf (ft)
1	4.347	111.290
2	21.128	97.831
3	70.143	87.954
4	153.317	115.491
5	182.141	124.653
6	230.706	144.471
7	251.201	151.532
8	354.313	185.139
9	377.570	192.243
10	400.117	232.558

Factor of Safety
 *** 1.559 ***

Failure Surface Specified By 10 Coordinate Points

Point No.	X-Surf (ft)	Y-Surf (ft)
1	4.347	111.290
2	21.128	97.831
3	70.143	87.954
4	153.317	115.491
5	182.141	124.653
6	230.706	144.471
7	251.201	151.532

8	354.313	185.139
9	377.570	192.243
10	400.117	232.558

Factor of Safety

*** 1.559 ***

**** END OF GSTABL7 OUTPUT ****

C-C' / Existing / Search Along Clay / Outside PL (Block)

z:\2010\10132-01 south shores church - dana point\engineering\2013_01\cc'.pl2 Run By: James Thomasson 1/8/2013 02:36PM

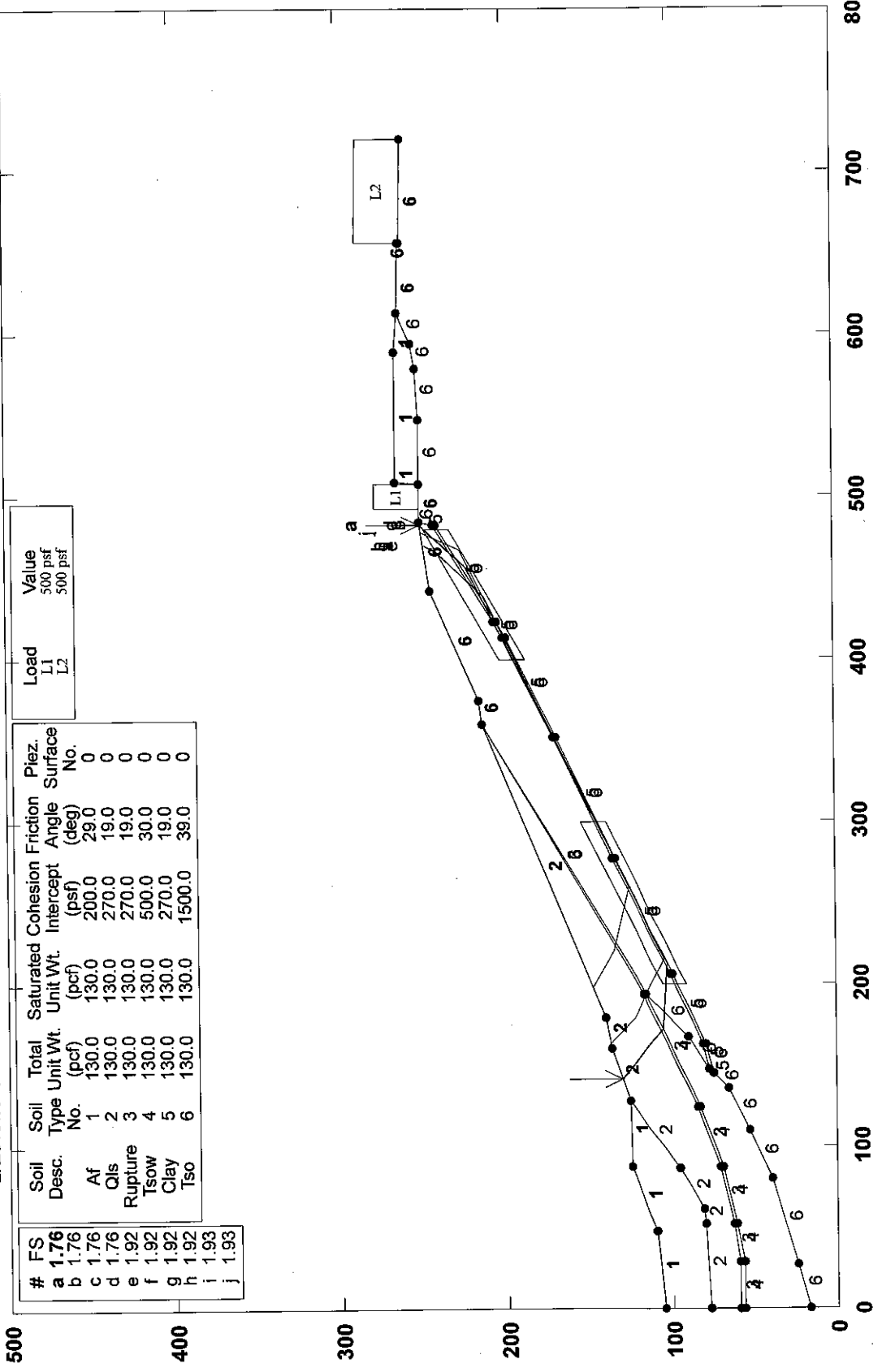

#	Soil Desc.	Soil Type No.	Total Unit Wt. (pcf)	Saturated Unit Wt. (pcf)	Cohesion Intercept (psf)	Friction Angle (deg)	Piez. Surface No.
a	Af	1	130.0	130.0	200.0	29.0	0
b	Qls	2	130.0	130.0	270.0	19.0	0
c	Rupture	3	130.0	130.0	270.0	19.0	0
d	Tsow	4	130.0	130.0	500.0	30.0	0
e	Clay	5	130.0	130.0	270.0	19.0	0
f	Tso	6	130.0	130.0	1500.0	39.0	0

Load	Value
L1	500 psf
L2	500 psf

#	FS
a	1.76
b	1.76
c	1.76
d	1.92
e	1.92
f	1.92
g	1.92
h	1.92
i	1.93
j	1.93

GSTABL7 v.2 FSmin=1.76

Safety Factors Are Calculated By The Simplified Janbu Method for the case of c & phi both > 0

*** GSTABL7 ***

** GSTABL7 by Dr. Garry H. Gregory, Ph.D., P.E., D.GE **
 ** Original Version 1.0, January 1996; Current Ver. 2.005.2, Jan. 2011 **
 (All Rights Reserved-Unauthorized Use Prohibited)

SLOPE STABILITY ANALYSIS SYSTEM

Modified Bishop, Simplified Janbu, or GLE Method of Slices.
 (Includes Spencer & Morgenstern-Price Type Analysis)
 Including Pier/File, Reinforcement, Soil Nail, Tieback,
 Nonlinear Undrained Shear Strength, Curved Phi Envelope,
 Anisotropic Soil, Fiber-Reinforced Soil, Boundary Loads, Water
 Surfaces, Pseudo-Static & Newmark Earthquake, and Applied Forces.

Analysis Run Date: 1/8/2013
 Time of Run: 02:36PM
 Run By: James Thomasson
 Input Data Filename: Z:\2010\10132-01 South Shores Church - Dana Point\Engineerin
 g\2013_10\cc'.
 Output Filename: Z:\2010\10132-01 South Shores Church - Dana Point\Engineerin
 g\2013_10\cc'.OUT
 Unit System: English
 Plotted Output Filename: Z:\2010\10132-01 South Shores Church - Dana Point\Engineerin
 g\2013_10\cc'.PLT
 PROBLEM DESCRIPTION: C-C' / Existing / Search Along Clay /
 Outside PL (Block)

BOUNDARY COORDINATES

16 Top Boundaries
 60 Total Boundaries

Boundary No.	X-Left (ft)	Y-Left (ft)	X-Right (ft)	Y-Right (ft)	Soil Type Below Bnd
1	0.00	105.00	48.00	110.00	1
2	48.00	110.00	87.00	125.00	1
3	87.00	125.00	128.00	126.00	1
4	128.00	126.00	160.00	137.00	2
5	160.00	137.00	179.00	140.00	2
6	179.00	140.00	360.00	213.00	2
7	360.00	213.00	374.00	215.00	6
8	374.00	215.00	442.00	244.00	6
9	442.00	244.00	484.10	250.00	6
10	484.10	250.00	508.00	250.00	6
11	508.00	250.00	508.10	265.00	1
12	508.10	265.00	589.00	265.00	1
13	589.00	265.00	613.00	263.00	1
14	613.00	263.00	656.00	262.00	6
15	656.00	262.00	656.10	261.00	6
16	656.10	261.00	720.00	260.00	6
17	0.00	77.00	52.00	80.00	2
18	52.00	80.00	61.00	81.00	2
19	61.00	81.00	86.00	95.00	2
20	86.00	95.00	128.00	126.00	2
21	0.00	59.00	29.00	59.00	3
22	29.00	59.00	52.00	63.00	3
23	52.00	63.00	87.00	71.00	3
24	87.00	71.00	124.00	85.00	3
25	124.00	85.00	193.10	117.00	3
26	193.10	117.00	360.00	213.00	3
27	0.00	57.00	29.00	57.00	4
28	29.00	57.00	52.00	61.00	4
29	52.00	61.00	87.00	69.00	4
30	87.00	69.00	124.00	83.00	4
31	124.00	83.00	193.10	115.00	4
32	193.10	115.00	360.00	213.00	6
33	0.00	17.00	27.00	24.00	6
34	27.00	24.00	80.00	40.00	6
35	80.00	40.00	110.00	53.00	6
36	110.00	53.00	136.00	66.00	6
37	136.00	66.00	145.00	75.00	6

38	145.00	75.00	148.00	77.00	5
39	148.00	77.00	167.00	90.00	6
40	167.00	90.00	193.10	115.00	6
41	148.00	77.00	163.00	81.00	5
42	163.00	81.00	206.00	101.00	5
43	206.00	101.00	277.00	136.00	5
44	277.00	136.00	352.00	171.00	5
45	352.00	171.00	413.00	201.00	5
46	413.00	201.00	423.00	206.00	5
47	423.00	206.00	482.00	242.00	5
48	482.00	242.00	484.10	250.00	5
49	145.00	75.00	163.00	79.00	6
50	163.00	79.00	206.00	99.00	6
51	206.00	99.00	277.00	134.00	6
52	277.00	134.00	352.00	169.00	6
53	352.00	169.00	413.00	199.00	6
54	413.00	199.00	423.00	204.00	6
55	423.00	204.00	482.00	240.00	6
56	482.00	240.00	484.10	250.00	6
57	508.00	250.00	547.00	250.00	6
58	547.00	250.00	579.00	252.00	6
59	579.00	252.00	594.00	255.00	6
60	594.00	255.00	613.00	263.00	6

Default Y-Origin = 0.00(ft)
 Default X-Plus Value = 0.00(ft)
 Default Y-Plus Value = 0.00(ft)

ISOTROPIC SOIL PARAMETERS

6 Type(s) of Soil

Soil Type No.	Total Unit Wt. (pcf)	Saturated Unit Wt. (pcf)	Cohesion Intercept (psf)	Friction Angle (deg)	Pore Pressure Param.	Pressure Constant (psf)	Piez. Surface No.
1	130.0	130.0	200.0	29.0	0.00	0.0	0
2	130.0	130.0	270.0	19.0	0.00	0.0	0
3	130.0	130.0	270.0	19.0	0.00	0.0	0
4	130.0	130.0	500.0	30.0	0.00	0.0	0
5	130.0	130.0	270.0	19.0	0.00	0.0	0
6	130.0	130.0	1500.0	39.0	0.00	0.0	0

BOUNDARY LOAD(S)

2 Load(s) Specified

Load No.	X-Left (ft)	X-Right (ft)	Intensity (psf)	Deflection (deg)
1	492.00	508.00	500.0	0.0
2	656.10	720.00	500.0	0.0

NOTE - Intensity Is Specified As A Uniformly Distributed Force Acting On A Horizontally Projected Surface.

Janbus Empirical Coef is being used for the case of c & phi both > 0
 A Critical Failure Surface Searching Method, Using A Random Technique For Generating Sliding Block Surfaces, Has Been Specified.

2000 Trial Surfaces Have Been Generated.

2 Boxes Specified For Generation Of Central Block Base
 Length Of Line Segments For Active And Passive Portions Of Sliding Block Is 40.0

Box No.	X-Left (ft)	Y-Left (ft)	X-Right (ft)	Y-Right (ft)	Height (ft)
1	200.00	98.00	300.00	147.00	15.00
2	400.00	195.00	480.00	240.00	15.00

Following Are Displayed The Ten Most Critical Of The Trial Failure Surfaces Evaluated. They Are Ordered - Most Critical First.

* * Safety Factors Are Calculated By The Simplified Janbu Method * *

Total Number of Trial Surfaces Attempted = 2000

Number of Trial Surfaces With Valid FS = 2000

Statistical Data On All Valid FS Values:

FS Max = 5.501 FS Min = 1.764 FS Ave = 3.644

Standard Deviation = 0.513 Coefficient of Variation = 14.07 %

Failure Surface Specified By 5 Coordinate Points

Point No.	X-Surf (ft)	Y-Surf (ft)
1	141.302	130.573
2	172.136	105.412
3	212.006	102.186
4	456.597	222.261
5	482.728	249.804

Factor of Safety
 *** 1.764 ***

Slice No.	Width (ft)	Weight (lbs)	Water Force		Tie Force		Earthquake Force		Surcharge Load (lbs)
			Top (lbs)	Bot (lbs)	Norm (lbs)	Tan (lbs)	Hor (lbs)	Ver (lbs)	
1	18.7	26355.3	0.0	0.0	0.	0.	0.0	0.0	0.0
2	10.7	37272.5	0.0	0.0	0.	0.	0.0	0.0	0.0
3	1.5	6262.2	0.0	0.0	0.	0.	0.0	0.0	0.0
4	0.2	968.2	0.0	0.0	0.	0.	0.0	0.0	0.0
5	6.6	29659.5	0.0	0.0	0.	0.	0.0	0.0	0.0
6	3.2	15119.5	0.0	0.0	0.	0.	0.0	0.0	0.0
7	10.9	55555.2	0.0	0.0	0.	0.	0.0	0.0	0.0
8	15.8	94155.1	0.0	0.0	0.	0.	0.0	0.0	0.0
9	3.1	20247.3	0.0	0.0	0.	0.	0.0	0.0	0.0
10	65.0	407917.9	0.0	0.0	0.	0.	0.0	0.0	0.0
11	75.0	410927.6	0.0	0.0	0.	0.	0.0	0.0	0.0
12	8.0	40051.3	0.0	0.0	0.	0.	0.0	0.0	0.0
13	14.0	65017.7	0.0	0.0	0.	0.	0.0	0.0	0.0
14	39.0	162396.2	0.0	0.0	0.	0.	0.0	0.0	0.0
15	10.0	39587.4	0.0	0.0	0.	0.	0.0	0.0	0.0
16	14.8	57133.8	0.0	0.0	0.	0.	0.0	0.0	0.0
17	4.2	15773.9	0.0	0.0	0.	0.	0.0	0.0	0.0
18	14.6	50024.3	0.0	0.0	0.	0.	0.0	0.0	0.0
19	5.0	14111.1	0.0	0.0	0.	0.	0.0	0.0	0.0
20	4.5	10055.9	0.0	0.0	0.	0.	0.0	0.0	0.0
21	16.6	16290.7	0.0	0.0	0.	0.	0.0	0.0	0.0

Failure Surface Specified By 5 Coordinate Points

Point No.	X-Surf (ft)	Y-Surf (ft)
1	141.302	130.573
2	172.136	105.412
3	212.006	102.186
4	456.597	222.261
5	482.728	249.804

Factor of Safety
 *** 1.764 ***

Failure Surface Specified By 5 Coordinate Points

Point No.	X-Surf (ft)	Y-Surf (ft)
1	141.302	130.573
2	172.136	105.412
3	212.006	102.186
4	456.597	222.261
5	482.728	249.804

Factor of Safety
 *** 1.764 ***

Failure Surface Specified By 5 Coordinate Points

Point No.	X-Surf (ft)	Y-Surf (ft)
1	141.302	130.573
2	172.136	105.412
3	212.006	102.186
4	456.597	222.261
5	482.728	249.804

Factor of Safety
 *** 1.764 ***

Failure Surface Specified By 6 Coordinate Points

Point	X-Surf	Y-Surf
-------	--------	--------

No.	(ft)	(ft)
1	198.375	147.814
2	220.204	134.960
3	259.198	126.047
4	438.257	211.890
5	465.961	240.743
6	469.367	247.900

Factor of Safety
 *** 1.915 ***

Failure Surface Specified By 6 Coordinate Points

Point	X-Surf	Y-Surf
No.	(ft)	(ft)
1	198.375	147.814
2	220.204	134.960
3	259.198	126.047
4	438.257	211.890
5	465.961	240.743
6	469.367	247.900

Factor of Safety
 *** 1.915 ***

Failure Surface Specified By 6 Coordinate Points

Point	X-Surf	Y-Surf
No.	(ft)	(ft)
1	198.375	147.814
2	220.204	134.960
3	259.198	126.047
4	438.257	211.890
5	465.961	240.743
6	469.367	247.900

Factor of Safety
 *** 1.915 ***

Failure Surface Specified By 6 Coordinate Points

Point	X-Surf	Y-Surf
No.	(ft)	(ft)
1	198.375	147.814
2	220.204	134.960
3	259.198	126.047
4	438.257	211.890
5	465.961	240.743
6	469.367	247.900

Factor of Safety
 *** 1.915 ***

Failure Surface Specified By 5 Coordinate Points

Point	X-Surf	Y-Surf
No.	(ft)	(ft)
1	163.276	137.517
2	178.669	122.144
3	214.691	104.755
4	467.183	225.659
5	477.626	249.077

Factor of Safety
 *** 1.932 ***

Failure Surface Specified By 5 Coordinate Points

Point	X-Surf	Y-Surf
No.	(ft)	(ft)
1	163.276	137.517
2	178.669	122.144
3	214.691	104.755
4	467.183	225.659
5	477.626	249.077

Factor of Safety
 *** 1.932 ***

**** END OF GSTABL7 OUTPUT ****

C-C' / Existing / Search Along Clay / Outside PL (Block)

z:\2010\10132-01 south shores church - dana point\engineering\2013_01\cc_1.p2 Run By: Username 1/15/2013 10:42AM

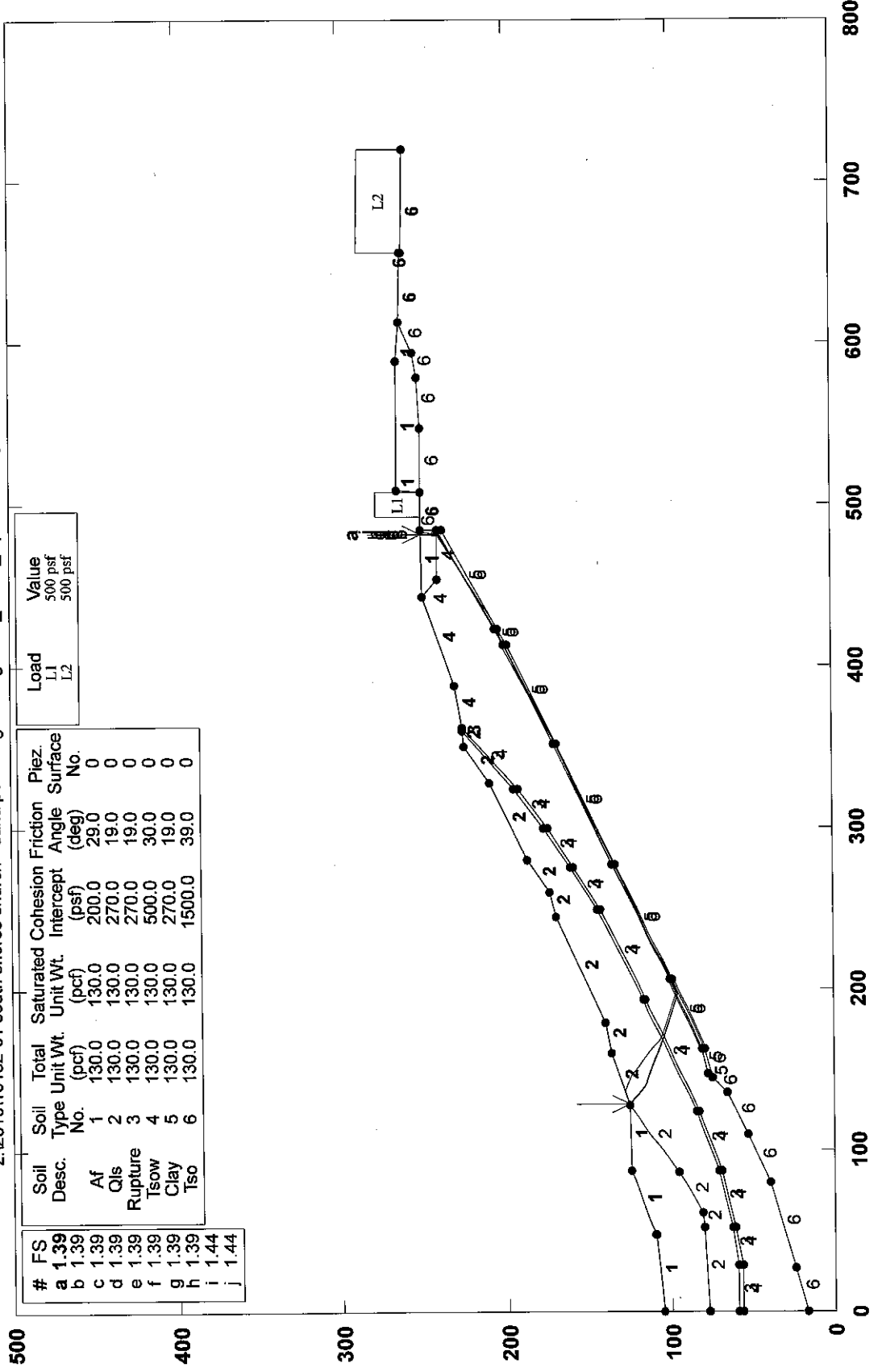

#	FS	Soil Desc.	Soil Type No.	Total Unit Wt. (pcf)	Saturated Unit Wt. (pcf)	Cohesion Intercept (psf)	Friction Angle (deg)	Piez. Surface No.
a	1.39	Af	1	130.0	130.0	200.0	29.0	0
b	1.39	Qls	2	130.0	130.0	270.0	19.0	0
c	1.39	Rupture	3	130.0	130.0	270.0	19.0	0
d	1.39	Tsow	4	130.0	130.0	500.0	30.0	0
e	1.39	Clay	5	130.0	130.0	270.0	19.0	0
f	1.39	Tso	6	130.0	130.0	1500.0	39.0	0

Load	Value
L1	500 psf
L2	500 psf

i	1.44
j	1.44

GSTABL7 v.2 FSmin=1.39

Safety Factors Are Calculated By The Simplified Janbu Method for the case of c & phi both > 0

*** GSTABL7 ***

** GSTABL7 by Dr. Garry H. Gregory, Ph.D., P.E., D.GE **
 ** Original Version 1.0, January 1996; Current Ver. 2.005.2, Jan. 2011 **
 (All Rights Reserved-Unauthorized Use Prohibited)

SLOPE STABILITY ANALYSIS SYSTEM

Modified Bishop, Simplified Janbu, or GLE Method of Slices.
 (Includes Spencer & Morgenstern-Price Type Analysis)
 Including Pier/Pile, Reinforcement, Soil Nail, Tieback,
 Nonlinear Undrained Shear Strength, Curved Phi Envelope,
 Anisotropic Soil, Fiber-Reinforced Soil, Boundary Loads, Water
 Surfaces, Pseudo-Static & Newmark Earthquake, and Applied Forces.

Analysis Run Date: 1/15/2013
 Time of Run: 10:42AM
 Run By: Username
 Input Data Filename: Z:\2010\10132-01 South Shores Church - Dana Point\Engineerin
 g\2013_01\cc'_1.
 Output Filename: Z:\2010\10132-01 South Shores Church - Dana Point\Engineerin
 g\2013_01\cc'_1.OUT
 Unit System: English
 Plotted Output Filename: Z:\2010\10132-01 South Shores Church - Dana Point\Engineerin
 g\2013_01\cc'_1.PLT
 PROBLEM DESCRIPTION: C-C' / Existing / Search Along Clay /
 Outside PL (Block)

BOUNDARY COORDINATES
 22 Top Boundaries
 73 Total Boundaries

Boundary No.	X-Left (ft)	Y-Left (ft)	X-Right (ft)	Y-Right (ft)	Soil Type Below Bnd
1	0.00	105.00	48.00	110.00	1
2	48.00	110.00	87.00	125.00	1
3	87.00	125.00	128.00	126.00	1
4	128.00	126.00	160.00	137.00	2
5	160.00	137.00	179.00	140.00	2
6	179.00	140.00	245.00	170.00	2
7	245.00	170.00	260.00	174.00	2
8	260.00	174.00	280.00	187.00	2
9	280.00	187.00	328.00	210.00	2
10	328.00	210.00	350.00	225.00	2
11	350.00	225.00	360.00	226.00	2
12	360.00	226.00	362.00	226.00	3
13	362.00	226.00	388.00	230.00	4
14	388.00	230.00	443.00	249.00	4
15	443.00	249.00	484.10	250.00	1
16	484.10	250.00	508.00	250.00	6
17	508.00	250.00	508.10	265.00	1
18	508.10	265.00	589.00	265.00	1
19	589.00	265.00	613.00	263.00	1
20	613.00	263.00	656.00	262.00	6
21	656.00	262.00	656.10	261.00	6
22	656.10	261.00	720.00	260.00	6
23	0.00	77.00	52.00	80.00	2
24	52.00	80.00	61.00	81.00	2
25	61.00	81.00	86.00	95.00	2
26	86.00	95.00	128.00	126.00	2
27	0.00	59.00	29.00	59.00	3
28	29.00	59.00	52.00	63.00	3
29	52.00	63.00	87.00	71.00	3
30	87.00	71.00	124.00	85.00	3
31	124.00	85.00	193.10	117.00	3
32	193.10	117.00	249.00	145.00	3
33	249.00	145.00	275.00	161.00	3
34	275.00	161.00	300.00	177.00	3
35	300.00	177.00	324.00	195.00	3
36	324.00	195.00	360.00	226.00	3
37	0.00	57.00	29.00	57.00	4

38	29.00	57.00	52.00	61.00	4
39	52.00	61.00	87.00	69.00	4
40	87.00	69.00	124.00	83.00	4
41	124.00	83.00	193.10	115.00	4
42	193.10	115.00	249.00	143.00	4
43	249.00	143.00	275.00	159.00	4
44	275.00	159.00	300.00	175.00	4
45	300.00	175.00	324.00	193.00	4
46	324.00	193.00	362.00	226.00	4
47	443.00	249.00	454.00	240.00	4
48	454.00	240.00	484.00	240.00	4
49	484.00	240.00	484.10	250.00	6
50	0.00	17.00	27.00	24.00	6
51	27.00	24.00	80.00	40.00	6
52	80.00	40.00	110.00	53.00	6
53	110.00	53.00	136.00	66.00	6
54	136.00	66.00	145.00	75.00	6
55	145.00	75.00	148.00	77.00	5
56	148.00	77.00	163.00	81.00	5
57	163.00	81.00	206.00	101.00	5
58	206.00	101.00	277.00	136.00	5
59	277.00	136.00	352.00	171.00	5
60	352.00	171.00	413.00	201.00	5
61	413.00	201.00	423.00	206.00	5
62	423.00	206.00	484.00	240.00	5
63	145.00	75.00	163.00	79.00	6
64	163.00	79.00	206.00	99.00	6
65	206.00	99.00	277.00	134.00	6
66	277.00	134.00	352.00	169.00	6
67	352.00	169.00	413.00	199.00	6
68	413.00	199.00	423.00	204.00	6
69	423.00	204.00	484.00	238.00	6
70	508.00	250.00	547.00	250.00	6
71	547.00	250.00	579.00	252.00	6
72	579.00	252.00	594.00	255.00	6
73	594.00	255.00	613.00	263.00	6

Default Y-Origin = 0.00(ft)
 Default X-Plus Value = 0.00(ft)
 Default Y-Plus Value = 0.00(ft)

ISOTROPIC SOIL PARAMETERS

6 Type(s) of Soil

Soil Type No.	Total (pcf)	Saturated (pcf)	Cohesion Intercept (psf)	Friction Angle (deg)	Pore Pressure Param. (psf)	Pressure Constant (psf)	Piez. Surface No.
1	130.0	130.0	200.0	29.0	0.00	0.0	0
2	130.0	130.0	270.0	19.0	0.00	0.0	0
3	130.0	130.0	270.0	19.0	0.00	0.0	0
4	130.0	130.0	500.0	30.0	0.00	0.0	0
5	130.0	130.0	270.0	19.0	0.00	0.0	0
6	130.0	130.0	1500.0	39.0	0.00	0.0	0

BOUNDARY LOAD(S)

2 Load(s) Specified

Load No.	X-Left (ft)	X-Right (ft)	Intensity (psf)	Deflection (deg)
1	492.00	508.00	500.0	0.0
2	656.10	720.00	500.0	0.0

NOTE - Intensity Is Specified As A Uniformly Distributed Force Acting On A Horizontally Projected Surface.
 Janbus Empirical Coef is being used for the case of c & phi both > 0
 A Critical Failure Surface Searching Method, Using A Random Technique For Generating Sliding Block Surfaces, Has Been Specified.

2000 Trial Surfaces Have Been Generated.

6 Boxes Specified For Generation Of Central Block Base
 Length Of Line Segments For Active And Passive Portions Of Sliding Block Is 30.0

Box	X-Left	Y-Left	X-Right	Y-Right	Height
-----	--------	--------	---------	---------	--------

No.	(ft)	(ft)	(ft)	(ft)	(ft)
1	163.00	80.00	206.00	100.00	4.00
2	276.00	135.00	278.00	135.00	4.00
3	351.00	170.00	353.00	170.00	4.00
4	412.00	200.00	414.00	200.00	4.00
5	422.00	205.00	424.00	205.00	4.00
6	481.00	241.00	483.00	241.00	4.00

Following Are Displayed The Ten Most Critical Of The Trial

Failure Surfaces Evaluated. They Are Ordered - Most Critical First.

* * Safety Factors Are Calculated By The Simplified Janbu Method * *

Total Number of Trial Surfaces Attempted = 2000

Number of Trial Surfaces With Valid FS = 2000

Statistical Data On All Valid FS Values:

FS Max = 2.853 FS Min = 1.386 FS Ave = 1.833

Standard Deviation = 0.261 Coefficient of Variation = 14.26 %

Failure Surface Specified By 10 Coordinate Points

Point No.	X-Surf (ft)	Y-Surf (ft)
1	128.425	126.146
2	140.021	114.895
3	168.580	105.710
4	196.738	95.359
5	277.346	136.040
6	352.989	170.460
7	412.687	200.802
8	422.128	204.940
9	481.498	239.751
10	481.943	249.948

Factor of Safety

*** 1.386 ***

Individual data on the 36 slices

Slice No.	Width (ft)	Weight (lbs)	Water Force		Tie Force		Earthquake Force		Surcharge Load (lbs)
			Top (lbs)	Bot (lbs)	Norm (lbs)	Tan (lbs)	Hor (lbs)	Ver (lbs)	
1	11.6	11484.4	0.0	0.0	0.	0.	0.0	0.0	0.0
2	20.0	56837.5	0.0	0.0	0.	0.	0.0	0.0	0.0
3	8.6	34119.0	0.0	0.0	0.	0.	0.0	0.0	0.0
4	0.1	330.9	0.0	0.0	0.	0.	0.0	0.0	0.0
5	2.4	10428.4	0.0	0.0	0.	0.	0.0	0.0	0.0
6	7.9	37168.7	0.0	0.0	0.	0.	0.0	0.0	0.0
7	14.1	80499.3	0.0	0.0	0.	0.	0.0	0.0	0.0
8	2.0	13386.2	0.0	0.0	0.	0.	0.0	0.0	0.0
9	1.6	10832.9	0.0	0.0	0.	0.	0.0	0.0	0.0
10	9.3	63178.4	0.0	0.0	0.	0.	0.0	0.0	0.0
11	39.0	259898.1	0.0	0.0	0.	0.	0.0	0.0	0.0
12	4.0	25900.3	0.0	0.0	0.	0.	0.0	0.0	0.0
13	11.0	68673.2	0.0	0.0	0.	0.	0.0	0.0	0.0
14	15.0	93217.9	0.0	0.0	0.	0.	0.0	0.0	0.0
15	2.0	12750.2	0.0	0.0	0.	0.	0.0	0.0	0.0
16	0.3	2210.8	0.0	0.0	0.	0.	0.0	0.0	0.0
17	2.7	17079.0	0.0	0.0	0.	0.	0.0	0.0	0.0
18	20.0	129983.8	0.0	0.0	0.	0.	0.0	0.0	0.0
19	24.0	157637.4	0.0	0.0	0.	0.	0.0	0.0	0.0
20	4.0	26448.6	0.0	0.0	0.	0.	0.0	0.0	0.0
21	22.0	152740.4	0.0	0.0	0.	0.	0.0	0.0	0.0
22	2.0	14441.8	0.0	0.0	0.	0.	0.0	0.0	0.0
23	1.0	7074.2	0.0	0.0	0.	0.	0.0	0.0	0.0
24	7.0	48676.8	0.0	0.0	0.	0.	0.0	0.0	0.0
25	2.0	13381.9	0.0	0.0	0.	0.	0.0	0.0	0.0
26	26.0	156673.8	0.0	0.0	0.	0.	0.0	0.0	0.0
27	24.7	127528.3	0.0	0.0	0.	0.	0.0	0.0	0.0
28	0.3	1532.7	0.0	0.0	0.	0.	0.0	0.0	0.0
29	9.1	44229.4	0.0	0.0	0.	0.	0.0	0.0	0.0
30	0.9	4166.3	0.0	0.0	0.	0.	0.0	0.0	0.0
31	18.9	84601.3	0.0	0.0	0.	0.	0.0	0.0	0.0

32	1.1	4398.2	0.0	0.0	0.	0.	0.0	0.0	0.0
33	11.0	41085.1	0.0	0.0	0.	0.	0.0	0.0	0.0
34	27.5	64033.7	0.0	0.0	0.	0.	0.0	0.0	0.0
35	0.0	14.2	0.0	0.0	0.	0.	0.0	0.0	0.0
36	0.4	280.2	0.0	0.0	0.	0.	0.0	0.0	0.0

Failure Surface Specified By 10 Coordinate Points

Point No.	X-Surf (ft)	Y-Surf (ft)
1	128.425	126.146
2	140.021	114.895
3	168.580	105.710
4	196.738	95.359
5	277.346	136.040
6	352.989	170.460
7	412.687	200.802
8	422.128	204.940
9	481.498	239.751
10	481.943	249.948

Factor of Safety
 *** 1.386 ***

Failure Surface Specified By 10 Coordinate Points

Point No.	X-Surf (ft)	Y-Surf (ft)
1	128.425	126.146
2	140.021	114.895
3	168.580	105.710
4	196.738	95.359
5	277.346	136.040
6	352.989	170.460
7	412.687	200.802
8	422.128	204.940
9	481.498	239.751
10	481.943	249.948

Factor of Safety
 *** 1.386 ***

Failure Surface Specified By 10 Coordinate Points

Point No.	X-Surf (ft)	Y-Surf (ft)
1	128.425	126.146
2	140.021	114.895
3	168.580	105.710
4	196.738	95.359
5	277.346	136.040
6	352.989	170.460
7	412.687	200.802
8	422.128	204.940
9	481.498	239.751
10	481.943	249.948

Factor of Safety
 *** 1.386 ***

Failure Surface Specified By 10 Coordinate Points

Point No.	X-Surf (ft)	Y-Surf (ft)
1	128.425	126.146
2	140.021	114.895
3	168.580	105.710
4	196.738	95.359
5	277.346	136.040
6	352.989	170.460
7	412.687	200.802
8	422.128	204.940
9	481.498	239.751
10	481.943	249.948

Factor of Safety
 *** 1.386 ***

Failure Surface Specified By 10 Coordinate Points

Point	X-Surf	Y-Surf
-------	--------	--------

No.	(ft)	(ft)
1	128.425	126.146
2	140.021	114.895
3	168.580	105.710
4	196.738	95.359
5	277.346	136.040
6	352.989	170.460
7	412.687	200.802
8	422.128	204.940
9	481.498	239.751
10	481.943	249.948

Factor of Safety
 *** 1.386 ***

Failure Surface Specified By 10 Coordinate Points

Point No.	X-Surf (ft)	Y-Surf (ft)
1	128.425	126.146
2	140.021	114.895
3	168.580	105.710
4	196.738	95.359
5	277.346	136.040
6	352.989	170.460
7	412.687	200.802
8	422.128	204.940
9	481.498	239.751
10	481.943	249.948

Factor of Safety
 *** 1.386 ***

Failure Surface Specified By 10 Coordinate Points

Point No.	X-Surf (ft)	Y-Surf (ft)
1	128.425	126.146
2	140.021	114.895
3	168.580	105.710
4	196.738	95.359
5	277.346	136.040
6	352.989	170.460
7	412.687	200.802
8	422.128	204.940
9	481.498	239.751
10	481.943	249.948

Factor of Safety
 *** 1.386 ***

Failure Surface Specified By 10 Coordinate Points

Point No.	X-Surf (ft)	Y-Surf (ft)
1	136.672	128.981
2	145.780	124.654
3	169.563	106.368
4	197.903	96.529
5	277.849	135.097
6	351.161	169.635
7	412.495	201.281
8	422.291	203.412
9	481.486	240.402
10	483.403	249.983

Factor of Safety
 *** 1.438 ***

Failure Surface Specified By 10 Coordinate Points

Point No.	X-Surf (ft)	Y-Surf (ft)
1	136.672	128.981
2	145.780	124.654
3	169.563	106.368
4	197.903	96.529
5	277.849	135.097
6	351.161	169.635

7	412.495	201.281
8	422.291	203.412
9	481.486	240.402
10	483.403	249.983

Factor of Safety

*** 1.438 ***

**** END OF GSTABL7 OUTPUT ****

C-C' / Existing / Search Along Rupture /Outside PL (Block)

z:\2010\10132-01 south shores church - dana point\engineering\2013_01\cc_2.p12 Run By: Username 1/15/2013 10:57AM

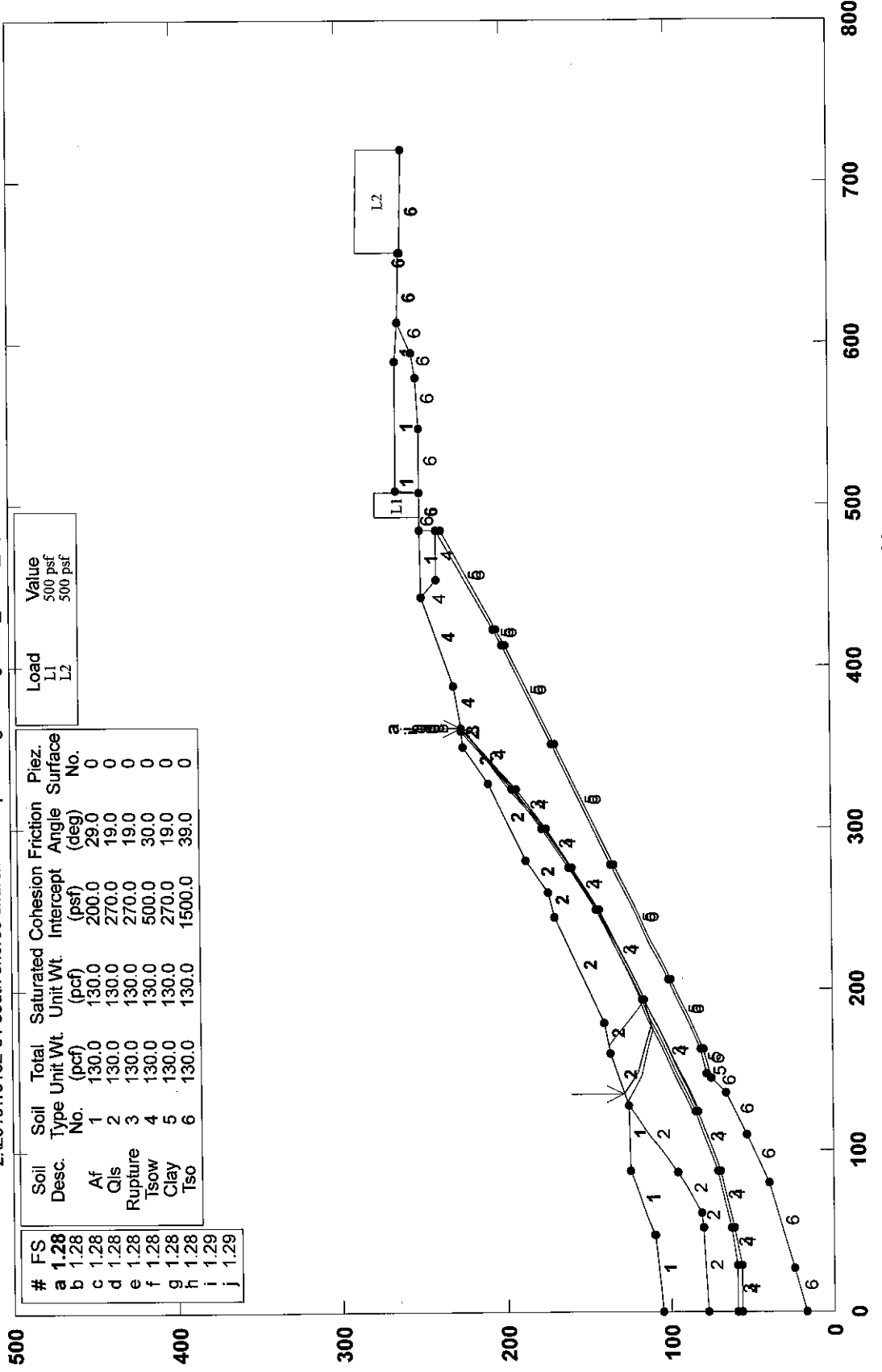

#	FS	Soil Desc.	Soil Type No.	Total Unit Wt. (pcf)	Saturated Unit Wt. (pcf)	Cohesion Intercept (psf)	Friction Angle (deg)	Piez. Surface No.
a	1.28	Af	1	130.0	130.0	200.0	29.0	0
b	1.28	Qls	2	130.0	130.0	270.0	19.0	0
c	1.28	Rupture	3	130.0	130.0	270.0	19.0	0
d	1.28	Tsow	4	130.0	130.0	500.0	30.0	0
e	1.28	Clay	5	130.0	130.0	270.0	19.0	0
f	1.28	Tso	6	130.0	130.0	1500.0	39.0	0
g	1.28							
h	1.28							
i	1.29							
j	1.29							

Load	Value
L1	500 psf
L2	500 psf

GSTABL7 v.2 FSmin=1.28

Safety Factors Are Calculated By The Simplified Janbu Method for the case of c & phi both > 0

*** GSTABL7 ***

** GSTABL7 by Dr. Garry H. Gregory, Ph.D., P.E., D.GE **
 ** Original Version 1.0, January 1996; Current Ver. 2.005.2, Jan. 2011 **
 (All Rights Reserved-Unauthorized Use Prohibited)

SLOPE STABILITY ANALYSIS SYSTEM

Modified Bishop, Simplified Janbu, or GLE Method of Slices.
 (Includes Spencer & Morgenstern-Price Type Analysis)
 Including Pier/Pile, Reinforcement, Soil Nail, Tieback,
 Nonlinear Undrained Shear Strength, Curved Phi Envelope,
 Anisotropic Soil, Fiber-Reinforced Soil, Boundary Loads, Water
 Surfaces, Pseudo-Static & Newmark Earthquake, and Applied Forces.

Analysis Run Date: 1/15/2013
 Time of Run: 10:57AM
 Run By: Username
 Input Data Filename: Z:\2010\10132-01 South Shores Church - Dana Point\Engineerin
 g\2013_01\cc' 2.
 Output Filename: Z:\2010\10132-01 South Shores Church - Dana Point\Engineerin
 g\2013_01\cc' 2.OUT
 Unit System: English
 Plotted Output Filename: Z:\2010\10132-01 South Shores Church - Dana Point\Engineerin
 g\2013_01\cc' 2.PLT
 PROBLEM DESCRIPTION: C-C' / Existing / Search Along Rupture /
 Outside PL (Block)

BOUNDARY COORDINATES

22 Top Boundaries
 73 Total Boundaries

Boundary No.	X-Left (ft)	Y-Left (ft)	X-Right (ft)	Y-Right (ft)	Soil Type Below Bnd
1	0.00	105.00	48.00	110.00	1
2	48.00	110.00	87.00	125.00	1
3	87.00	125.00	128.00	126.00	1
4	128.00	126.00	160.00	137.00	2
5	160.00	137.00	179.00	140.00	2
6	179.00	140.00	245.00	170.00	2
7	245.00	170.00	260.00	174.00	2
8	260.00	174.00	280.00	187.00	2
9	280.00	187.00	328.00	210.00	2
10	328.00	210.00	350.00	225.00	2
11	350.00	225.00	360.00	226.00	2
12	360.00	226.00	362.00	226.00	3
13	362.00	226.00	388.00	230.00	4
14	388.00	230.00	443.00	249.00	4
15	443.00	249.00	484.10	250.00	1
16	484.10	250.00	508.00	250.00	6
17	508.00	250.00	508.10	265.00	1
18	508.10	265.00	589.00	265.00	1
19	589.00	265.00	613.00	263.00	1
20	613.00	263.00	656.00	262.00	6
21	656.00	262.00	656.10	261.00	6
22	656.10	261.00	720.00	260.00	6
23	0.00	77.00	52.00	80.00	2
24	52.00	80.00	61.00	81.00	2
25	61.00	81.00	86.00	95.00	2
26	86.00	95.00	128.00	126.00	2
27	0.00	59.00	29.00	59.00	3
28	29.00	59.00	52.00	63.00	3
29	52.00	63.00	87.00	71.00	3
30	87.00	71.00	124.00	85.00	3
31	124.00	85.00	193.10	117.00	3
32	193.10	117.00	249.00	145.00	3
33	249.00	145.00	275.00	161.00	3
34	275.00	161.00	300.00	177.00	3
35	300.00	177.00	324.00	195.00	3
36	324.00	195.00	360.00	226.00	3
37	0.00	57.00	29.00	57.00	4

38	29.00	57.00	52.00	61.00	4
39	52.00	61.00	87.00	69.00	4
40	87.00	69.00	124.00	83.00	4
41	124.00	83.00	193.10	115.00	4
42	193.10	115.00	249.00	143.00	4
43	249.00	143.00	275.00	159.00	4
44	275.00	159.00	300.00	175.00	4
45	300.00	175.00	324.00	193.00	4
46	324.00	193.00	362.00	226.00	4
47	443.00	249.00	454.00	240.00	4
48	454.00	240.00	484.00	240.00	4
49	484.00	240.00	484.10	250.00	6
50	0.00	17.00	27.00	24.00	6
51	27.00	24.00	80.00	40.00	6
52	80.00	40.00	110.00	53.00	6
53	110.00	53.00	136.00	66.00	6
54	136.00	66.00	145.00	75.00	6
55	145.00	75.00	148.00	77.00	5
56	148.00	77.00	163.00	81.00	5
57	163.00	81.00	206.00	101.00	5
58	206.00	101.00	277.00	136.00	5
59	277.00	136.00	352.00	171.00	5
60	352.00	171.00	413.00	201.00	5
61	413.00	201.00	423.00	206.00	5
62	423.00	206.00	484.00	240.00	5
63	145.00	75.00	163.00	79.00	6
64	163.00	79.00	206.00	99.00	6
65	206.00	99.00	277.00	134.00	6
66	277.00	134.00	352.00	169.00	6
67	352.00	169.00	413.00	199.00	6
68	413.00	199.00	423.00	204.00	6
69	423.00	204.00	484.00	238.00	6
70	508.00	250.00	547.00	250.00	6
71	547.00	250.00	579.00	252.00	6
72	579.00	252.00	594.00	255.00	6
73	594.00	255.00	613.00	263.00	6

Default Y-Origin = 0.00(ft)
 Default X-Plus Value = 0.00(ft)
 Default Y-Plus Value = 0.00(ft)

ISOTROPIC SOIL PARAMETERS

6 Type(s) of Soil

Soil Type No.	Total Unit Wt. (pcf)	Saturated Unit Wt. (pcf)	Cohesion Intercept (psf)	Friction Angle (deg)	Pore Pressure Param.	Pressure Constant (psf)	Piez. Surface No.
1	130.0	130.0	200.0	29.0	0.00	0.0	0
2	130.0	130.0	270.0	19.0	0.00	0.0	0
3	130.0	130.0	270.0	19.0	0.00	0.0	0
4	130.0	130.0	500.0	30.0	0.00	0.0	0
5	130.0	130.0	270.0	19.0	0.00	0.0	0
6	130.0	130.0	1500.0	39.0	0.00	0.0	0

BOUNDARY LOAD(S)

2 Load(s) Specified

Load No.	X-Left (ft)	X-Right (ft)	Intensity (psf)	Deflection (deg)
1	492.00	508.00	500.0	0.0
2	656.10	720.00	500.0	0.0

NOTE - Intensity Is Specified As A Uniformly Distributed Force Acting On A Horizontally Projected Surface.
 Janbus Empirical Coef is being used for the case of c & phi both > 0
 A Critical Failure Surface Searching Method, Using A Random Technique For Generating Sliding Block Surfaces, Has Been Specified.

2000 Trial Surfaces Have Been Generated.

7 Boxes Specified For Generation Of Central Block Base

Length Of Line Segments For Active And Passive Portions Of Sliding Block Is 30.0

Box	X-Left	Y-Left	X-Right	Y-Right	Height
-----	--------	--------	---------	---------	--------

No.	(ft)	(ft)	(ft)	(ft)	(ft)
1	124.00	84.00	192.00	116.00	4.00
2	192.10	116.00	194.00	116.00	4.00
3	248.00	144.00	250.00	144.00	4.00
4	274.00	161.00	276.00	161.00	4.00
5	299.00	176.00	301.00	176.00	4.00
6	323.00	194.00	325.00	194.00	4.00
7	359.00	223.50	361.00	223.50	2.00

Following Are Displayed The Ten Most Critical Of The Trial

Failure Surfaces Evaluated. They Are
Ordered - Most Critical First.

* * Safety Factors Are Calculated By The Simplified Janbu Method * *

Total Number of Trial Surfaces Attempted = 2000

Number of Trial Surfaces With Valid FS = 2000

Statistical Data On All Valid FS Values:

FS Max = 2.206 FS Min = 1.281 FS Ave = 1.591

Standard Deviation = 0.177 Coefficient of Variation = 11.14 %

Failure Surface Specified By 10 Coordinate Points

Point No.	X-Surf (ft)	Y-Surf (ft)
1	135.233	128.486
2	148.932	120.140
3	177.469	110.886
4	193.066	115.215
5	249.297	143.939
6	274.351	159.273
7	300.616	175.592
8	323.029	194.269
9	359.028	223.341
10	361.686	226.000

Factor of Safety

*** 1.281 ***

Individual data on the 26 slices

Slice No.	Width (ft)	Weight (lbs)	Water Force		Tie Force		Earthquake Force		
			Top (lbs)	Bot (lbs)	Norm (lbs)	Tan (lbs)	Hor (lbs)	Ver (lbs)	Surcharge Load (lbs)
1	13.7	11625.3	0.0	0.0	0.	0.	0.0	0.0	0.0
2	11.1	24103.0	0.0	0.0	0.	0.	0.0	0.0	0.0
3	17.5	56004.5	0.0	0.0	0.	0.	0.0	0.0	0.0
4	1.5	5726.3	0.0	0.0	0.	0.	0.0	0.0	0.0
5	4.5	17133.7	0.0	0.0	0.	0.	0.0	0.0	0.0
6	9.5	37603.3	0.0	0.0	0.	0.	0.0	0.0	0.0
7	0.0	137.4	0.0	0.0	0.	0.	0.0	0.0	0.0
8	51.9	200497.7	0.0	0.0	0.	0.	0.0	0.0	0.0
9	4.0	14439.2	0.0	0.0	0.	0.	0.0	0.0	0.0
10	0.3	1052.7	0.0	0.0	0.	0.	0.0	0.0	0.0
11	10.7	35282.7	0.0	0.0	0.	0.	0.0	0.0	0.0
12	14.4	44369.3	0.0	0.0	0.	0.	0.0	0.0	0.0
13	0.6	2030.4	0.0	0.0	0.	0.	0.0	0.0	0.0
14	5.0	15694.4	0.0	0.0	0.	0.	0.0	0.0	0.0
15	20.0	59268.7	0.0	0.0	0.	0.	0.0	0.0	0.0
16	0.6	1707.0	0.0	0.0	0.	0.	0.0	0.0	0.0
17	22.4	50458.6	0.0	0.0	0.	0.	0.0	0.0	0.0
18	0.0	67.1	0.0	0.0	0.	0.	0.0	0.0	0.0
19	1.9	3274.9	0.0	0.0	0.	0.	0.0	0.0	0.0
20	3.0	4757.3	0.0	0.0	0.	0.	0.0	0.0	0.0
21	22.0	29552.1	0.0	0.0	0.	0.	0.0	0.0	0.0
22	7.7	6252.0	0.0	0.0	0.	0.	0.0	0.0	0.0
23	1.3	503.2	0.0	0.0	0.	0.	0.0	0.0	0.0
24	0.6	176.5	0.0	0.0	0.	0.	0.0	0.0	0.0
25	0.4	92.0	0.0	0.0	0.	0.	0.0	0.0	0.0
26	1.7	184.8	0.0	0.0	0.	0.	0.0	0.0	0.0

Failure Surface Specified By 10 Coordinate Points

Point No.	X-Surf (ft)	Y-Surf (ft)
1	135.233	128.486

2	148.932	120.140
3	177.469	110.886
4	193.066	115.215
5	249.297	143.939
6	274.351	159.273
7	300.616	175.592
8	323.029	194.269
9	359.028	223.341
10	361.686	226.000

Factor of Safety
 *** 1.281 ***

Failure Surface Specified By 10 Coordinate Points

Point No.	X-Surf (ft)	Y-Surf (ft)
1	135.233	128.486
2	148.932	120.140
3	177.469	110.886
4	193.066	115.215
5	249.297	143.939
6	274.351	159.273
7	300.616	175.592
8	323.029	194.269
9	359.028	223.341
10	361.686	226.000

Factor of Safety
 *** 1.281 ***

Failure Surface Specified By 10 Coordinate Points

Point No.	X-Surf (ft)	Y-Surf (ft)
1	135.233	128.486
2	148.932	120.140
3	177.469	110.886
4	193.066	115.215
5	249.297	143.939
6	274.351	159.273
7	300.616	175.592
8	323.029	194.269
9	359.028	223.341
10	361.686	226.000

Factor of Safety
 *** 1.281 ***

Failure Surface Specified By 10 Coordinate Points

Point No.	X-Surf (ft)	Y-Surf (ft)
1	135.233	128.486
2	148.932	120.140
3	177.469	110.886
4	193.066	115.215
5	249.297	143.939
6	274.351	159.273
7	300.616	175.592
8	323.029	194.269
9	359.028	223.341
10	361.686	226.000

Factor of Safety
 *** 1.281 ***

Failure Surface Specified By 10 Coordinate Points

Point No.	X-Surf (ft)	Y-Surf (ft)
1	135.233	128.486
2	148.932	120.140
3	177.469	110.886
4	193.066	115.215
5	249.297	143.939
6	274.351	159.273
7	300.616	175.592
8	323.029	194.269

9	359.028	223.341
10	361.686	226.000

Factor of Safety
 *** 1.281 ***

Failure Surface Specified By 10 Coordinate Points

Point No.	X-Surf (ft)	Y-Surf (ft)
1	135.233	128.486
2	148.932	120.140
3	177.469	110.886
4	193.066	115.215
5	249.297	143.939
6	274.351	159.273
7	300.616	175.592
8	323.029	194.269
9	359.028	223.341
10	361.686	226.000

Factor of Safety
 *** 1.281 ***

Failure Surface Specified By 10 Coordinate Points

Point No.	X-Surf (ft)	Y-Surf (ft)
1	135.233	128.486
2	148.932	120.140
3	177.469	110.886
4	193.066	115.215
5	249.297	143.939
6	274.351	159.273
7	300.616	175.592
8	323.029	194.269
9	359.028	223.341
10	361.686	226.000

Factor of Safety
 *** 1.281 ***

Failure Surface Specified By 10 Coordinate Points

Point No.	X-Surf (ft)	Y-Surf (ft)
1	164.985	137.787
2	167.179	135.760
3	190.568	116.973
4	193.436	117.489
5	249.597	144.128
6	274.717	159.438
7	299.454	176.296
8	324.996	194.575
9	359.030	224.076
10	359.275	225.927

Factor of Safety
 *** 1.287 ***

Failure Surface Specified By 10 Coordinate Points

Point No.	X-Surf (ft)	Y-Surf (ft)
1	130.045	126.703
2	146.589	116.647
3	175.892	110.219
4	192.417	115.985
5	249.259	144.718
6	275.488	159.872
7	300.710	176.323
8	323.111	195.946
9	359.380	223.308
10	361.510	226.000

Factor of Safety
 *** 1.294 ***

**** END OF GSTABL7 OUTPUT ****

C-C' / Existing / Search Along Clay / Outside PL (Circ)

z:\2010\10132-01 south shores church - dana point\engineering\2013_01\cc'c.pl2 Run By: James Thomsson 1/8/2013 02:42PM

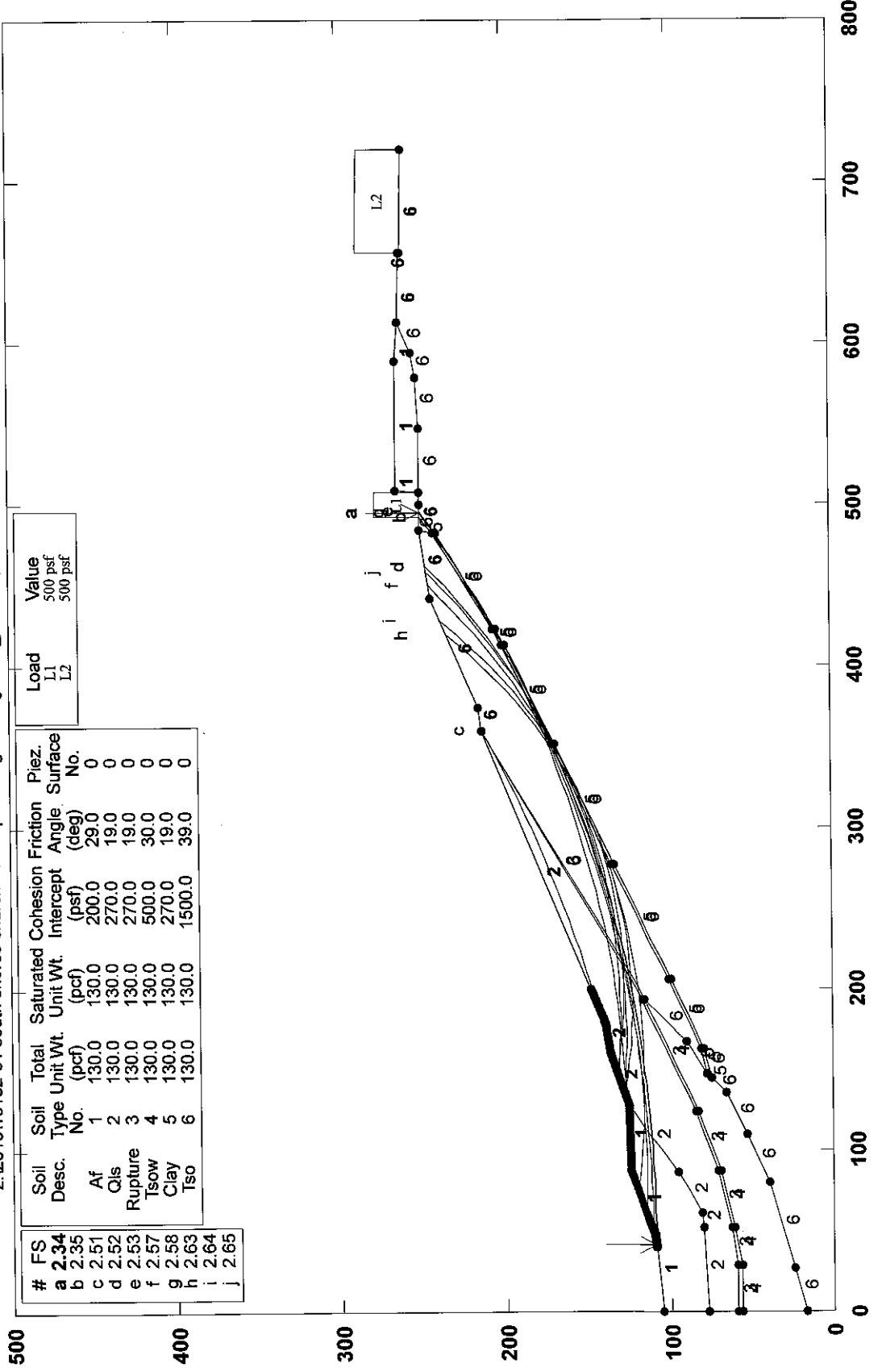

#	FS	Soil Desc.	Soil Type No.	Total Unit Wt. (pcf)	Saturated Unit Wt. (pcf)	Cohesion Intercept (psf)	Friction Angle (deg)	Piez. Surface No.
a	2.34	Af	1	130.0	130.0	200.0	29.0	0
b	2.35	Qls	2	130.0	130.0	270.0	19.0	0
c	2.51	Rupture	3	130.0	130.0	270.0	19.0	0
d	2.52	Tsow	4	130.0	130.0	500.0	30.0	0
e	2.53	Clay	5	130.0	130.0	270.0	19.0	0
f	2.57	Tso	6	130.0	130.0	1500.0	39.0	0
g	2.58							
h	2.63							
i	2.64							
j	2.65							

Load	Value
L1	500 psf
L2	500 psf

GSTABL7 v.2 FSmin=2.34

Safety Factors Are Calculated By The Modified Bishop Method

*** GSTABL7 ***

** GSTABL7 by Dr. Garry H. Gregory, Ph.D., P.E., D.GE **
 ** Original Version 1.0, January 1996; Current Ver. 2.005.2, Jan. 2011 **
 (All Rights Reserved-Unauthorized Use Prohibited)

SLOPE STABILITY ANALYSIS SYSTEM

Modified Bishop, Simplified Janbu, or GLE Method of Slices.
 (Includes Spencer & Morgenstern-Price Type Analysis)
 Including Pier/Pile, Reinforcement, Soil Nail, Tieback,
 Nonlinear Undrained Shear Strength, Curved Phi Envelope,
 Anisotropic Soil, Fiber-Reinforced Soil, Boundary Loads, Water
 Surfaces, Pseudo-Static & Newmark Earthquake, and Applied Forces.

Analysis Run Date: 1/8/2013
 Time of Run: 02:42PM
 Run By: James Thomasson
 Input Data Filename: Z:\2010\10132-01 South Shores Church - Dana Point\Engineering\2013_10\cc'c.
 Output Filename: Z:\2010\10132-01 South Shores Church - Dana Point\Engineering\2013_10\cc'c.OUT
 Unit System: English
 Plotted Output Filename: Z:\2010\10132-01 South Shores Church - Dana Point\Engineering\2013_10\cc'c.PLT
 PROBLEM DESCRIPTION: C-C' / Existing / Search Along Clay / Outside PL (Circ)

BOUNDARY COORDINATES

16 Top Boundaries
 60 Total Boundaries

Boundary No.	X-Left (ft)	Y-Left (ft)	X-Right (ft)	Y-Right (ft)	Soil Type Below Bnd
1	0.00	105.00	48.00	110.00	1
2	48.00	110.00	87.00	125.00	1
3	87.00	125.00	128.00	126.00	1
4	128.00	126.00	160.00	137.00	2
5	160.00	137.00	179.00	140.00	2
6	179.00	140.00	360.00	213.00	2
7	360.00	213.00	374.00	215.00	6
8	374.00	215.00	442.00	244.00	6
9	442.00	244.00	484.10	250.00	6
10	484.10	250.00	508.00	250.00	6
11	508.00	250.00	508.10	265.00	1
12	508.10	265.00	589.00	265.00	1
13	589.00	265.00	613.00	263.00	1
14	613.00	263.00	656.00	262.00	6
15	656.00	262.00	656.10	261.00	6
16	656.10	261.00	720.00	260.00	6
17	0.00	77.00	52.00	80.00	2
18	52.00	80.00	61.00	81.00	2
19	61.00	81.00	86.00	95.00	2
20	86.00	95.00	128.00	126.00	2
21	0.00	59.00	29.00	59.00	3
22	29.00	59.00	52.00	63.00	3
23	52.00	63.00	87.00	71.00	3
24	87.00	71.00	124.00	85.00	3
25	124.00	85.00	193.10	117.00	3
26	193.10	117.00	360.00	213.00	3
27	0.00	57.00	29.00	57.00	4
28	29.00	57.00	52.00	61.00	4
29	52.00	61.00	87.00	69.00	4
30	87.00	69.00	124.00	83.00	4
31	124.00	83.00	193.10	115.00	4
32	193.10	115.00	360.00	213.00	6
33	0.00	17.00	27.00	24.00	6
34	27.00	24.00	80.00	40.00	6
35	80.00	40.00	110.00	53.00	6
36	110.00	53.00	136.00	66.00	6
37	136.00	66.00	145.00	75.00	6

38	145.00	75.00	148.00	77.00	5
39	148.00	77.00	167.00	90.00	6
40	167.00	90.00	193.10	115.00	6
41	148.00	77.00	163.00	81.00	5
42	163.00	81.00	206.00	101.00	5
43	206.00	101.00	277.00	136.00	5
44	277.00	136.00	352.00	171.00	5
45	352.00	171.00	413.00	201.00	5
46	413.00	201.00	423.00	206.00	5
47	423.00	206.00	482.00	242.00	5
48	482.00	242.00	484.10	250.00	5
49	145.00	75.00	163.00	79.00	6
50	163.00	79.00	206.00	99.00	6
51	206.00	99.00	277.00	134.00	6
52	277.00	134.00	352.00	169.00	6
53	352.00	169.00	413.00	199.00	6
54	413.00	199.00	423.00	204.00	6
55	423.00	204.00	482.00	240.00	6
56	482.00	240.00	484.10	250.00	6
57	508.00	250.00	547.00	250.00	6
58	547.00	250.00	579.00	252.00	6
59	579.00	252.00	594.00	255.00	6
60	594.00	255.00	613.00	263.00	6

Default Y-Origin = 0.00(ft)
 Default X-Plus Value = 0.00(ft)
 Default Y-Plus Value = 0.00(ft)

ISOTROPIC SOIL PARAMETERS

6 Type(s) of Soil

Soil Type No.	Total Unit Wt. (pcf)	Saturated Unit Wt. (pcf)	Cohesion Intercept (psf)	Friction Angle (deg)	Pore Pressure Param. (psf)	Pressure Constant (psf)	Piez. Surface No.
1	130.0	130.0	200.0	29.0	0.00	0.0	0
2	130.0	130.0	270.0	19.0	0.00	0.0	0
3	130.0	130.0	270.0	19.0	0.00	0.0	0
4	130.0	130.0	500.0	30.0	0.00	0.0	0
5	130.0	130.0	270.0	19.0	0.00	0.0	0
6	130.0	130.0	1500.0	39.0	0.00	0.0	0

BOUNDARY LOAD(S)

2 Load(s) Specified

Load No.	X-Left (ft)	X-Right (ft)	Intensity (psf)	Deflection (deg)
1	492.00	508.00	500.0	0.0
2	656.10	720.00	500.0	0.0

NOTE - Intensity Is Specified As A Uniformly Distributed Force Acting On A Horizontally Projected Surface.

A Critical Failure Surface Searching Method, Using A Random Technique For Generating Circular Surfaces, Has Been Specified. 3000 Trial Surfaces Have Been Generated.

30 Surface(s) Initiate(s) From Each Of 100 Points Equally Spaced Along The Ground Surface Between X = 40.00(ft)

and X = 200.00(ft)

Each Surface Terminates Between X = 360.00(ft)

and X = 500.00(ft)

Unless Further Limitations Were Imposed, The Minimum Elevation At Which A Surface Extends Is Y = 0.00(ft)

10.00(ft) Line Segments Define Each Trial Failure Surface.

Following Are Displayed The Ten Most Critical Of The Trial

Failure Surfaces Evaluated. They Are

Ordered - Most Critical First.

* * Safety Factors Are Calculated By The Modified Bishop Method * *

Total Number of Trial Surfaces Attempted = 3000

Number of Trial Surfaces With Valid FS = 3000

Statistical Data On All Valid FS Values:

FS Max = 4.948 FS Min = 2.336 FS Ave = 3.807

Standard Deviation = 0.500 Coefficient of Variation = 13.15 %

Failure Surface Specified By 50 Coordinate Points

Point X-Surf Y-Surf

No.	(ft)	(ft)
1	41.616	109.335
2	51.616	109.285
3	61.616	109.365
4	71.614	109.574
5	81.608	109.912
6	91.597	110.379
7	101.579	110.976
8	111.553	111.701
9	121.516	112.555
10	131.468	113.538
11	141.406	114.649
12	151.329	115.889
13	161.235	117.257
14	171.122	118.753
15	180.990	120.377
16	190.835	122.128
17	200.657	124.006
18	210.454	126.011
19	220.224	128.142
20	229.966	130.400
21	239.678	132.783
22	249.358	135.291
23	259.005	137.925
24	268.617	140.683
25	278.193	143.565
26	287.731	146.570
27	297.229	149.699
28	306.686	152.950
29	316.100	156.323
30	325.469	159.817
31	334.793	163.432
32	344.069	167.168
33	353.296	171.023
34	362.472	174.997
35	371.597	179.089
36	380.667	183.299
37	389.683	187.626
38	398.642	192.068
39	407.542	196.627
40	416.383	201.300
41	425.163	206.087
42	433.880	210.987
43	442.534	215.999
44	451.121	221.123
45	459.642	226.357
46	468.094	231.701
47	476.477	237.154
48	484.788	242.714
49	493.027	248.382
50	495.315	250.000

Circle Center At X = 50.474 ; Y = 882.775 ; and Radius = 773.490

Factor of Safety
 *** 2.336 ***

Slice No.	Width (ft)	Weight (lbs)	Water		Tie		Earthquake		
			Force Top (lbs)	Force Bot (lbs)	Force Norm (lbs)	Force Tan (lbs)	Force Hor (lbs)	Force Ver (lbs)	Surcharge Load (lbs)
1	6.4	289.1	0.0	0.0	0.	0.	0.0	0.0	0.0
2	3.6	658.6	0.0	0.0	0.	0.	0.0	0.0	0.0
3	10.0	5185.0	0.0	0.0	0.	0.	0.0	0.0	0.0
4	10.0	9994.8	0.0	0.0	0.	0.	0.0	0.0	0.0
5	10.0	14631.1	0.0	0.0	0.	0.	0.0	0.0	0.0
6	5.4	9761.1	0.0	0.0	0.	0.	0.0	0.0	0.0
7	4.6	8835.0	0.0	0.0	0.	0.	0.0	0.0	0.0
8	10.0	18889.6	0.0	0.0	0.	0.	0.0	0.0	0.0

9	6.7	12435.5	0.0	0.0	0.	0.	0.0	0.0	0.0
10	3.2	5896.7	0.0	0.0	0.	0.	0.0	0.0	0.0
11	10.0	17605.4	0.0	0.0	0.	0.	0.0	0.0	0.0
12	6.5	10996.0	0.0	0.0	0.	0.	0.0	0.0	0.0
13	3.5	5964.0	0.0	0.0	0.	0.	0.0	0.0	0.0
14	9.9	19129.1	0.0	0.0	0.	0.	0.0	0.0	0.0
15	9.9	21986.8	0.0	0.0	0.	0.	0.0	0.0	0.0
16	8.7	21442.5	0.0	0.0	0.	0.	0.0	0.0	0.0
17	1.2	3198.3	0.0	0.0	0.	0.	0.0	0.0	0.0
18	9.9	25669.4	0.0	0.0	0.	0.	0.0	0.0	0.0
19	7.9	20458.6	0.0	0.0	0.	0.	0.0	0.0	0.0
20	2.0	5221.4	0.0	0.0	0.	0.	0.0	0.0	0.0
21	9.8	27563.8	0.0	0.0	0.	0.	0.0	0.0	0.0
22	9.8	30245.4	0.0	0.0	0.	0.	0.0	0.0	0.0
23	7.2	23733.3	0.0	0.0	0.	0.	0.0	0.0	0.0
24	2.6	9000.9	0.0	0.0	0.	0.	0.0	0.0	0.0
25	2.2	7772.4	0.0	0.0	0.	0.	0.0	0.0	0.0
26	7.5	27257.4	0.0	0.0	0.	0.	0.0	0.0	0.0
27	9.7	37132.2	0.0	0.0	0.	0.	0.0	0.0	0.0
28	9.7	39041.3	0.0	0.0	0.	0.	0.0	0.0	0.0
29	9.7	40757.4	0.0	0.0	0.	0.	0.0	0.0	0.0
30	9.6	42281.0	0.0	0.0	0.	0.	0.0	0.0	0.0
31	9.6	43612.9	0.0	0.0	0.	0.	0.0	0.0	0.0
32	9.6	44753.9	0.0	0.0	0.	0.	0.0	0.0	0.0
33	9.5	45705.1	0.0	0.0	0.	0.	0.0	0.0	0.0
34	9.5	46467.9	0.0	0.0	0.	0.	0.0	0.0	0.0
35	9.5	47043.9	0.0	0.0	0.	0.	0.0	0.0	0.0
36	9.4	47434.8	0.0	0.0	0.	0.	0.0	0.0	0.0
37	9.4	47642.6	0.0	0.0	0.	0.	0.0	0.0	0.0
38	9.3	47669.3	0.0	0.0	0.	0.	0.0	0.0	0.0
39	7.2	37018.1	0.0	0.0	0.	0.	0.0	0.0	0.0
40	2.0	10499.2	0.0	0.0	0.	0.	0.0	0.0	0.0
41	7.9	40571.1	0.0	0.0	0.	0.	0.0	0.0	0.0
42	1.3	6618.3	0.0	0.0	0.	0.	0.0	0.0	0.0
43	6.7	34140.7	0.0	0.0	0.	0.	0.0	0.0	0.0
44	2.5	12443.9	0.0	0.0	0.	0.	0.0	0.0	0.0
45	9.1	43843.1	0.0	0.0	0.	0.	0.0	0.0	0.0
46	2.4	10991.3	0.0	0.0	0.	0.	0.0	0.0	0.0
47	6.7	30051.2	0.0	0.0	0.	0.	0.0	0.0	0.0
48	9.0	40204.5	0.0	0.0	0.	0.	0.0	0.0	0.0
49	9.0	39308.8	0.0	0.0	0.	0.	0.0	0.0	0.0
50	8.9	38252.4	0.0	0.0	0.	0.	0.0	0.0	0.0
51	5.5	22986.8	0.0	0.0	0.	0.	0.0	0.0	0.0
52	3.4	14052.3	0.0	0.0	0.	0.	0.0	0.0	0.0
53	6.6	26994.0	0.0	0.0	0.	0.	0.0	0.0	0.0
54	2.2	8679.0	0.0	0.0	0.	0.	0.0	0.0	0.0
55	8.7	34157.9	0.0	0.0	0.	0.	0.0	0.0	0.0
56	8.1	30537.1	0.0	0.0	0.	0.	0.0	0.0	0.0
57	0.5	1956.0	0.0	0.0	0.	0.	0.0	0.0	0.0
58	5.9	20556.9	0.0	0.0	0.	0.	0.0	0.0	0.0
59	2.7	8611.4	0.0	0.0	0.	0.	0.0	0.0	0.0
60	8.5	24554.7	0.0	0.0	0.	0.	0.0	0.0	0.0
61	0.0	119.3	0.0	0.0	0.	0.	0.0	0.0	0.0
62	8.4	19755.6	0.0	0.0	0.	0.	0.0	0.0	0.0
63	8.4	15135.4	0.0	0.0	0.	0.	0.0	0.0	0.0
64	5.5	7399.7	0.0	0.0	0.	0.	0.0	0.0	0.0
65	0.2	237.2	0.0	0.0	0.	0.	0.0	0.0	0.0
66	1.9	2028.5	0.0	0.0	0.	0.	0.0	0.0	0.0
67	0.7	672.5	0.0	0.0	0.	0.	0.0	0.0	0.0
68	7.2	4505.0	0.0	0.0	0.	0.	0.0	0.0	0.0
69	1.0	263.2	0.0	0.0	0.	0.	0.0	0.0	513.5
70	2.3	240.7	0.0	0.0	0.	0.	0.0	0.0	1144.1

Failure Surface Specified By 48 Coordinate Points

Point No.	X-Surf (ft)	Y-Surf (ft)
1	59.394	114.382
2	69.393	114.264

3	79.393	114.285
4	89.392	114.445
5	99.387	114.745
6	109.378	115.185
7	119.361	115.764
8	129.335	116.482
9	139.298	117.340
10	149.248	118.337
11	159.184	119.472
12	169.102	120.746
13	179.002	122.159
14	188.881	123.710
15	198.738	125.398
16	208.569	127.224
17	218.375	129.187
18	228.152	131.286
19	237.899	133.522
20	247.613	135.894
21	257.294	138.401
22	266.939	141.043
23	276.546	143.820
24	286.113	146.730
25	295.638	149.774
26	305.120	152.950
27	314.557	156.259
28	323.947	159.699
29	333.288	163.269
30	342.578	166.970
31	351.815	170.800
32	360.998	174.759
33	370.125	178.846
34	379.194	183.059
35	388.203	187.399
36	397.151	191.864
37	406.035	196.454
38	414.855	201.167
39	423.608	206.003
40	432.292	210.961
41	440.907	216.039
42	449.450	221.237
43	457.919	226.555
44	466.313	231.989
45	474.631	237.541
46	482.870	243.208
47	491.029	248.989
48	492.414	250.000

Circle Center At X = 72.908 ; Y = 830.348 ; and Radius = 716.093

Factor of Safety

*** 2.354 ***

Failure Surface Specified By 19 Coordinate Points

Point No.	X-Surf (ft)	Y-Surf (ft)
1	195.152	146.514
2	204.782	149.209
3	214.376	152.030
4	223.932	154.976
5	233.449	158.048
6	242.924	161.243
7	252.357	164.563
8	261.746	168.006
9	271.088	171.572
10	280.383	175.260
11	289.629	179.070
12	298.824	183.000
13	307.967	187.051
14	317.056	191.221
15	326.090	195.510

16	335.066	199.917
17	343.984	204.442
18	352.842	209.083
19	360.117	213.017

Circle Center At X = -5.595 ; Y = 882.451 ; and Radius = 762.826

Factor of Safety
 *** 2.512 ***

Failure Surface Specified By 37 Coordinate Points

Point No.	X-Surf (ft)	Y-Surf (ft)
1	135.354	128.528
2	145.330	127.844
3	155.320	127.400
4	165.318	127.194
5	175.318	127.227
6	185.315	127.499
7	195.301	128.010
8	205.273	128.760
9	215.224	129.748
10	225.149	130.973
11	235.042	132.435
12	244.896	134.133
13	254.708	136.066
14	264.470	138.233
15	274.178	140.633
16	283.826	143.264
17	293.408	146.125
18	302.918	149.214
19	312.353	152.530
20	321.705	156.070
21	330.970	159.832
22	340.143	163.815
23	349.218	168.016
24	358.190	172.433
25	367.053	177.063
26	375.804	181.903
27	384.436	186.952
28	392.945	192.205
29	401.326	197.660
30	409.575	203.313
31	417.686	209.162
32	425.654	215.204
33	433.477	221.434
34	441.148	227.849
35	448.663	234.446
36	456.019	241.220
37	461.819	246.825

Circle Center At X = 168.929 ; Y = 545.560 ; and Radius = 418.381

Factor of Safety
 *** 2.523 ***

Failure Surface Specified By 49 Coordinate Points

Point No.	X-Surf (ft)	Y-Surf (ft)
1	49.697	110.653
2	59.696	110.804
3	69.692	111.080
4	79.684	111.479
5	89.670	112.002
6	99.649	112.649
7	109.620	113.420
8	119.580	114.314
9	129.528	115.332
10	139.462	116.472
11	149.382	117.736
12	159.286	119.123
13	169.171	120.632
14	179.037	122.264

15	188.882	124.017
16	198.705	125.893
17	208.503	127.890
18	218.276	130.009
19	228.022	132.248
20	237.740	134.609
21	247.427	137.089
22	257.083	139.689
23	266.706	142.409
24	276.295	145.248
25	285.847	148.205
26	295.363	151.281
27	304.839	154.474
28	314.275	157.785
29	323.670	161.212
30	333.021	164.755
31	342.327	168.414
32	351.588	172.189
33	360.801	176.077
34	369.965	180.080
35	379.079	184.195
36	388.141	188.424
37	397.150	192.764
38	406.104	197.216
39	415.003	201.778
40	423.844	206.450
41	432.627	211.232
42	441.350	216.122
43	450.011	221.120
44	458.610	226.224
45	467.145	231.435
46	475.615	236.752
47	484.018	242.172
48	492.354	247.697
49	495.737	250.000

Circle Center At X = 42.463 ; Y = 917.436 ; and Radius = 806.816

Factor of Safety

*** 2.529 ***

Failure Surface Specified By 42 Coordinate Points

Point No.	X-Surf (ft)	Y-Surf (ft)
1	75.556	120.598
2	85.458	119.205
3	95.390	118.041
4	105.346	117.106
5	115.321	116.400
6	125.310	115.925
7	135.307	115.680
8	145.307	115.665
9	155.305	115.881
10	165.295	116.327
11	175.272	117.003
12	185.231	117.909
13	195.166	119.044
14	205.073	120.408
15	214.945	122.000
16	224.778	123.819
17	234.567	125.864
18	244.306	128.134
19	253.990	130.628
20	263.614	133.344
21	273.173	136.282
22	282.661	139.439
23	292.075	142.814
24	301.408	146.404
25	310.656	150.209
26	319.813	154.227

27	328.876	158.454
28	337.839	162.888
29	346.697	167.529
30	355.446	172.372
31	364.081	177.415
32	372.598	182.656
33	380.991	188.092
34	389.257	193.720
35	397.391	199.537
36	405.389	205.540
37	413.246	211.725
38	420.959	218.090
39	428.523	224.631
40	435.935	231.345
41	443.189	238.227
42	450.172	245.165

Circle Center At X = 140.945 ; Y = 549.537 ; and Radius = 433.895
 Factor of Safety
 *** 2.569 ***

Failure Surface Specified By 40 Coordinate Points

Point No.	X-Surf (ft)	Y-Surf (ft)
1	132.121	127.417
2	142.110	127.901
3	152.090	128.531
4	162.060	129.307
5	172.017	130.230
6	181.960	131.297
7	191.886	132.511
8	201.793	133.869
9	211.680	135.372
10	221.543	137.020
11	231.381	138.812
12	241.192	140.748
13	250.973	142.827
14	260.723	145.050
15	270.440	147.414
16	280.120	149.921
17	289.763	152.569
18	299.367	155.358
19	308.928	158.287
20	318.445	161.356
21	327.917	164.564
22	337.341	167.910
23	346.714	171.393
24	356.036	175.014
25	365.303	178.771
26	374.515	182.662
27	383.668	186.689
28	392.762	190.848
29	401.794	195.141
30	410.762	199.565
31	419.665	204.120
32	428.499	208.805
33	437.264	213.619
34	445.958	218.560
35	454.579	223.628
36	463.124	228.822
37	471.593	234.140
38	479.983	239.582
39	488.292	245.146
40	495.316	250.000

Circle Center At X = 104.061 ; Y = 809.893 ; and Radius = 683.053
 Factor of Safety
 *** 2.579 ***

Failure Surface Specified By 33 Coordinate Points

Point	X-Surf	Y-Surf
-------	--------	--------

No.	(ft)	(ft)
1	135.354	128.528
2	145.216	126.872
3	155.128	125.553
4	165.080	124.570
5	175.059	123.925
6	185.054	123.620
7	195.054	123.654
8	205.047	124.027
9	215.022	124.738
10	224.967	125.788
11	234.870	127.175
12	244.721	128.897
13	254.507	130.952
14	264.218	133.338
15	273.843	136.052
16	283.370	139.091
17	292.789	142.452
18	302.088	146.130
19	311.256	150.122
20	320.284	154.422
21	329.161	159.026
22	337.877	163.929
23	346.421	169.125
24	354.785	174.607
25	362.957	180.370
26	370.929	186.407
27	378.691	192.711
28	386.236	199.275
29	393.553	206.091
30	400.635	213.152
31	407.473	220.448
32	414.059	227.973
33	419.216	234.283

Circle Center At X = 189.060 ; Y = 418.284 ; and Radius = 294.692

Factor of Safety
 *** 2.628 ***

Failure Surface Specified By 33 Coordinate Points

Point No.	X-Surf (ft)	Y-Surf (ft)
1	148.283	132.972
2	158.153	131.367
3	168.073	130.101
4	178.030	129.175
5	188.013	128.591
6	198.010	128.349
7	208.009	128.450
8	218.000	128.893
9	227.969	129.679
10	237.905	130.805
11	247.797	132.271
12	257.633	134.075
13	267.401	136.215
14	277.091	138.688
15	286.690	141.492
16	296.187	144.623
17	305.571	148.077
18	314.832	151.851
19	323.958	155.940
20	332.938	160.339
21	341.763	165.043
22	350.421	170.047
23	358.902	175.344
24	367.198	180.929
25	375.297	186.794
26	383.190	192.934
27	390.869	199.340

28	398.323	206.006
29	405.545	212.923
30	412.525	220.083
31	419.257	227.479
32	425.731	235.100
33	428.077	238.062

Circle Center At X = 200.066 ; Y = 420.224 ; and Radius = 291.882

Factor of Safety

*** 2.637 ***

Failure Surface Specified By 36 Coordinate Points

Point No.	X-Surf (ft)	Y-Surf (ft)
1	146.667	132.417
2	156.635	131.621
3	166.621	131.083
4	176.617	130.802
5	186.617	130.780
6	196.614	131.016
7	206.602	131.509
8	216.573	132.261
9	226.522	133.269
10	236.442	134.534
11	246.326	136.054
12	256.167	137.829
13	265.959	139.857
14	275.696	142.138
15	285.370	144.669
16	294.976	147.449
17	304.507	150.475
18	313.957	153.747
19	323.319	157.262
20	332.587	161.016
21	341.755	165.009
22	350.817	169.238
23	359.767	173.698
24	368.599	178.388
25	377.307	183.305
26	385.885	188.444
27	394.328	193.804
28	402.629	199.379
29	410.784	205.167
30	418.787	211.163
31	426.632	217.364
32	434.315	223.765
33	441.830	230.363
34	449.172	237.152
35	456.337	244.128
36	458.506	246.352

Circle Center At X = 182.501 ; Y = 518.057 ; and Radius = 387.301

Factor of Safety

*** 2.649 ***

**** END OF GSTABL7 OUTPUT ****

H-H' / Ait Design / Search Along Rupture/ Outside PL (Block)

z:\2010\10132-01 south shores church - dana point\engineering\2013_01\hh'_1.pl2 Run By: Useaname 1/15/2013 01:41PM

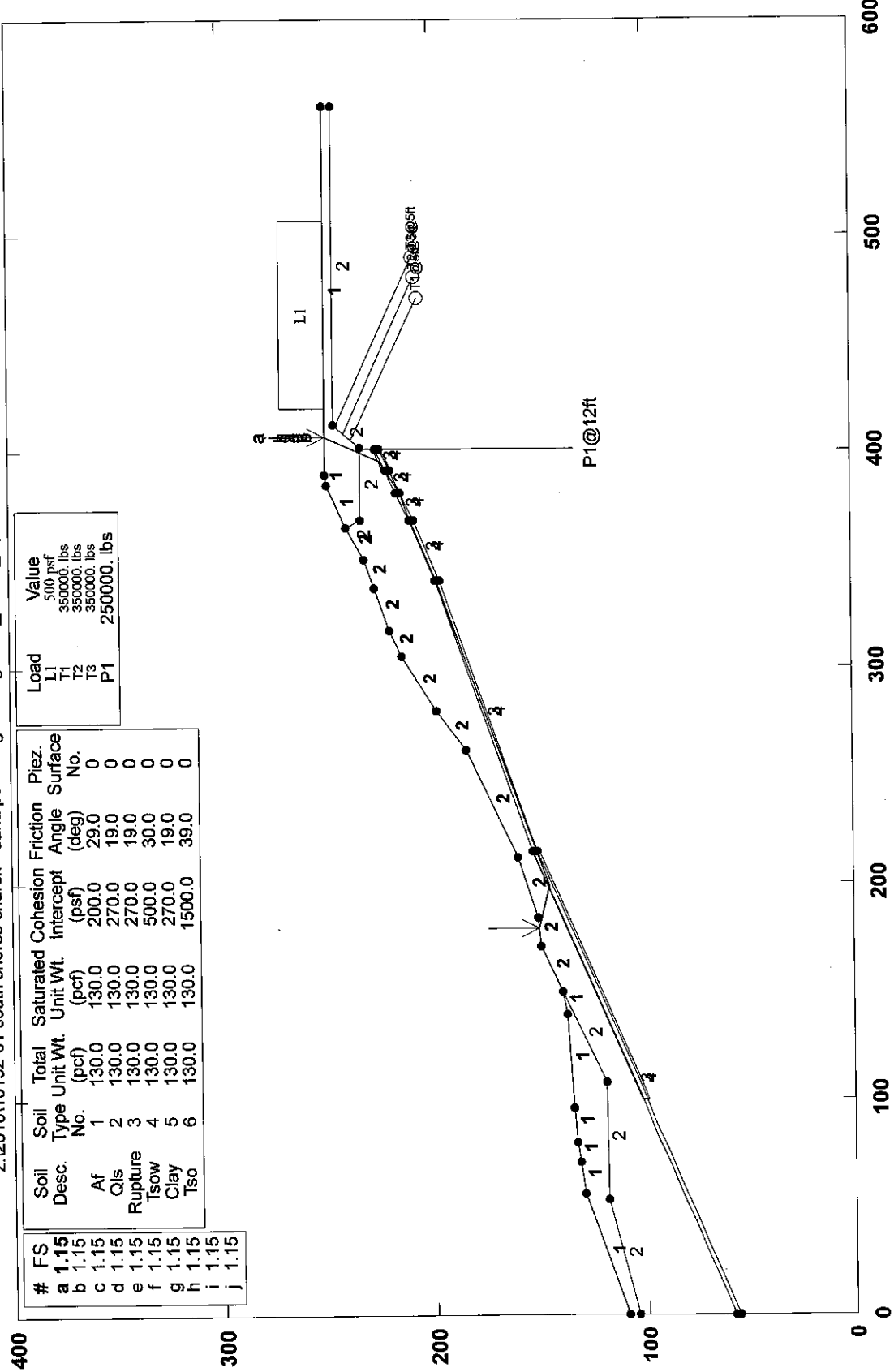

Load	Value
L1	500 psf
T1	350000. lbs
T2	350000. lbs
T3	350000. lbs
P1	2500000. lbs

Soil Desc.	Soil Type No.	Total Unit Wt. (pcf)	Saturated Unit Wt. (pcf)	Cohesion Intercept (psf)	Friction Angle (deg)	Piez. Surface No.
AF	1	130.0	130.0	200.0	29.0	0
Qls	2	130.0	130.0	270.0	19.0	0
Rupture	3	130.0	130.0	270.0	19.0	0
Tsow	4	130.0	130.0	500.0	30.0	0
Clay	5	130.0	130.0	270.0	19.0	0
Tso	6	130.0	130.0	1500.0	39.0	0

#	FS
a	1.15
b	1.15
c	1.15
d	1.15
e	1.15
f	1.15
g	1.15
h	1.15
i	1.15
j	1.15

GSTABL7 v.2 FSmin=1.15

Safety Factors Are Calculated By The Simplified Janbu Method for the case of c & phi both > 0

*** GSTABL7 ***

** GSTABL7 by Dr. Garry H. Gregory, Ph.D., P.E., D.GE **
 ** Original Version 1.0, January 1996; Current Ver. 2.005.2, Jan. 2011 **
 (All Rights Reserved-Unauthorized Use Prohibited)

SLOPE STABILITY ANALYSIS SYSTEM

Modified Bishop, Simplified Janbu, or GLE Method of Slices.
 (Includes Spencer & Morgenstern-Price Type Analysis)
 Including Pier/File, Reinforcement, Soil Nail, Tieback,
 Nonlinear Undrained Shear Strength, Curved Phi Envelope,
 Anisotropic Soil, Fiber-Reinforced Soil, Boundary Loads, Water
 Surfaces, Pseudo-Static & Newmark Earthquake, and Applied Forces.

Analysis Run Date: 1/15/2013
 Time of Run: 01:41PM
 Run By: Username
 Input Data Filename: Z:\2010\10132-01 South Shores Church - Dana Point\Engineering\2013_01\hh'_1.
 Output Filename: Z:\2010\10132-01 South Shores Church - Dana Point\Engineering\2013_01\hh'_1.OUT
 Unit System: English
 Plotted Output Filename: Z:\2010\10132-01 South Shores Church - Dana Point\Engineering\2013_01\hh'_1.PLT
 PROBLEM DESCRIPTION: H-H' / Alt Design / Search Along Rupture / Outside PL (Block)

BOUNDARY COORDINATES

19 Top Boundaries
 38 Total Boundaries

Boundary No.	X-Left (ft)	Y-Left (ft)	X-Right (ft)	Y-Right (ft)	Soil Type Below Bnd
1	0.00	110.00	56.00	130.00	1
2	56.00	130.00	71.00	132.00	1
3	71.00	132.00	80.00	134.00	1
4	80.00	134.00	96.00	135.00	1
5	96.00	135.00	139.00	138.00	1
6	139.00	138.00	150.00	140.00	1
7	150.00	140.00	171.00	150.00	2
8	171.00	150.00	184.00	151.00	2
9	184.00	151.00	212.00	160.00	2
10	212.00	160.00	262.00	184.00	2
11	262.00	184.00	280.00	198.00	2
12	280.00	198.00	305.00	214.00	2
13	305.00	214.00	317.00	220.00	2
14	317.00	220.00	337.00	227.00	2
15	337.00	227.00	350.00	232.00	2
16	350.00	232.00	365.00	240.00	2
17	365.00	240.00	384.00	249.00	1
18	384.00	249.00	389.00	250.00	1
19	389.00	250.00	560.00	250.00	1
20	0.00	105.00	53.00	119.00	2
21	53.00	119.00	108.00	120.00	2
22	108.00	120.00	150.00	140.00	2
23	365.00	240.00	368.00	233.00	2
24	368.00	233.00	402.00	233.00	2
25	402.00	233.00	412.00	246.00	2
26	412.00	246.00	560.00	246.00	2
27	0.00	58.00	215.00	153.00	3
28	215.00	153.00	340.00	198.00	3
29	340.00	198.00	368.00	210.00	3
30	368.00	210.00	381.00	216.00	3
31	381.00	216.00	391.00	221.00	3
32	391.00	221.00	401.00	226.00	3
33	0.00	56.00	215.00	151.00	4
34	215.00	151.00	340.00	196.00	4
35	340.00	196.00	368.00	208.00	4
36	368.00	208.00	381.00	214.00	4
37	381.00	214.00	391.00	219.00	4
38	391.00	219.00	401.00	224.00	4

Default Y-Origin = 0.00(ft)
 Default X-Plus Value = 0.00(ft)
 Default Y-Plus Value = 0.00(ft)

ISOTROPIC SOIL PARAMETERS

6 Type(s) of Soil

Soil Type No.	Total Unit Wt. (pcf)	Saturated Unit Wt. (pcf)	Cohesion Intercept (psf)	Friction Angle (deg)	Pore Pressure Param. (psf)	Pressure Constant (psf)	Piez. Surface No.
1	130.0	130.0	200.0	29.0	0.00	0.0	0
2	130.0	130.0	270.0	19.0	0.00	0.0	0
3	130.0	130.0	270.0	19.0	0.00	0.0	0
4	130.0	130.0	500.0	30.0	0.00	0.0	0
5	130.0	130.0	270.0	19.0	0.00	0.0	0
6	130.0	130.0	1500.0	39.0	0.00	0.0	0

BOUNDARY LOAD(S)

1 Load(s) Specified

Load No.	X-Left (ft)	X-Right (ft)	Intensity (psf)	Deflection (deg)
1	420.00	507.00	500.0	0.0

NOTE - Intensity Is Specified As A Uniformly Distributed Force Acting On A Horizontally Projected Surface.

TIEBACK LOAD(S)

3 Tieback Load(s) Specified

Tieback No.	X-Pos (ft)	Y-Pos (ft)	Load (lbs)	Spacing (ft)	Inclination (deg)	Length (ft)	Force Method
1	405.08	237.00	350000.0	5.0	25.00	73.0	2
2	408.15	241.00	350000.0	5.0	25.00	80.0	2
3	411.23	245.00	350000.0	5.0	25.00	87.0	2

NOTE - An Equivalent Line Load Is Calculated For Each Row Of Tiebacks Assuming A Uniform Distribution Of Load Horizontally Between Individual Tiebacks. Force Method 1 Considers Only Tangential Tieback Forces. Force Method 2 Considers Both Tangential and Normal Tieback Forces. Force Method 3 Considers Only Normal Tieback Forces. Force Method 4 Limits Normal and Tangential Tieback-Force Distribution to 1.5 Times the Tieback Inclination, or to 30 Degrees Below (Left of) the Tieback-Failure Surface Intersection, Whichever is Greater.

PIER/PILE LOAD(S)

1 Pier/Pile Load(s) Specified

Pier/Pile No.	X-Pos (ft)	Y-Pos (ft)	Load (lbs)	Spacing (ft)	Inclination (deg)	Length (ft)
1	401.00	233.00	250000.0	12.0	90.00	100.0

NOTE - An Equivalent Line Load Is Calculated For Each Row Of Piers/Piles Assuming A Uniform Distribution Of Load Horizontally Between Individual Piers/Piles.

Janbus Empirical Coef is being used for the case of c & phi both > 0
 A Critical Failure Surface Searching Method, Using A Random Technique For Generating Sliding Block Surfaces, Has Been Specified.

8000 Trial Surfaces Have Been Generated.

6 Boxes Specified For Generation Of Central Block Base

Length Of Line Segments For Active And Passive Portions Of Sliding Block Is 50.0

Box No.	X-Left (ft)	Y-Left (ft)	X-Right (ft)	Y-Right (ft)	Height (ft)
1	100.00	101.20	214.00	151.60	4.00
2	214.10	152.00	216.00	152.00	4.00
3	339.00	197.00	341.00	197.00	4.00
4	367.00	209.00	369.00	209.00	4.00
5	380.00	215.00	381.00	215.00	4.00
6	390.00	220.00	401.00	225.00	4.00

The Factor Of Safety For The Trial Failure Surface Defined By The Coordinates Listed Below Is Misleading.

Failure Surface Defined By 8 Coordinate Points

Point No.	X-Surf (ft)	Y-Surf (ft)
1	100.98	135.35
2	126.18	112.30

3	214.69	153.71
4	339.37	195.62
5	368.64	209.64
6	380.94	216.15
7	390.05	220.53
8	419.48	250.00

Factor Of Safety For The Preceding Specified Surface = -30.023
 The Factor Of Safety For The Trial Failure Surface Defined
 By The Coordinates Listed Below Is Misleading.
 Failure Surface Defined By 8 Coordinate Points

Point No.	X-Surf (ft)	Y-Surf (ft)
1	150.74	140.35
2	174.44	135.34
3	214.72	153.58
4	340.27	197.54
5	367.59	208.48
6	380.78	213.78
7	393.46	223.40
8	417.72	250.00

Factor Of Safety For The Preceding Specified Surface = -2.310
 The Factor Of Safety For The Trial Failure Surface Defined
 By The Coordinates Listed Below Is Misleading.
 Failure Surface Defined By 8 Coordinate Points

Point No.	X-Surf (ft)	Y-Surf (ft)
1	137.39	137.89
2	163.28	128.54
3	214.96	150.14
4	340.19	198.21
5	367.15	210.46
6	380.74	213.76
7	392.02	220.89
8	418.47	250.00

Factor Of Safety For The Preceding Specified Surface = -19.279
 The Factor Of Safety For The Trial Failure Surface Defined
 By The Coordinates Listed Below Is Misleading.
 Failure Surface Defined By 9 Coordinate Points

Point No.	X-Surf (ft)	Y-Surf (ft)
1	85.37	134.34
2	93.09	128.86
3	142.02	118.56
4	214.56	153.34
5	340.84	198.45
6	367.01	210.98
7	380.84	215.81
8	395.55	221.33
9	415.09	250.00

Factor Of Safety For The Preceding Specified Surface = -1.359
 The Factor Of Safety For The Trial Failure Surface Defined
 By The Coordinates Listed Below Is Misleading.
 Failure Surface Defined By 9 Coordinate Points

Point No.	X-Surf (ft)	Y-Surf (ft)
1	54.47	129.45
2	86.52	119.99
3	136.45	117.31
4	214.79	153.49
5	339.18	195.04
6	367.20	209.50
7	380.72	213.77
8	390.72	222.03
9	418.67	250.00

Factor Of Safety For The Preceding Specified Surface = -6.865
WARNING! The factor of safety calculation did not converge in 20 iterations.
 The Trial Failure Surface In Question Is Defined

By The Following 8 Coordinate Points

Point No.	X-Surf (ft)	Y-Surf (ft)
1	178.39	150.57
2	188.81	141.37
3	215.86	151.04
4	339.55	198.03
5	367.08	207.25
6	380.19	216.09
7	394.93	221.15
8	413.54	250.00

Factor of Safety for the Preceding Surface is Between-0.536 and-0.787

WARNING! The factor of safety calculation did not converge in 20 iterations.

The Trial Failure Surface In Question Is Defined

By The Following 8 Coordinate Points

Point No.	X-Surf (ft)	Y-Surf (ft)
1	86.85	134.43
2	124.07	113.03
3	214.55	153.52
4	339.74	197.84
5	367.15	208.52
6	380.58	215.93
7	399.21	223.64
8	413.23	250.00

Factor of Safety for the Preceding Surface is Between-0.405 and 1.645

The Factor Of Safety For The Trial Failure Surface Defined

By The Coordinates Listed Below Is Misleading.

Failure Surface Defined By 8 Coordinate Points

Point No.	X-Surf (ft)	Y-Surf (ft)
1	167.37	148.27
2	180.40	136.88
3	215.76	153.78
4	340.54	195.91
5	368.74	208.90
6	380.38	215.13
7	393.13	223.38
8	418.21	250.00

Factor Of Safety For The Preceding Specified Surface = -3.159

The Factor Of Safety For The Trial Failure Surface Defined

By The Coordinates Listed Below Is Misleading.

Failure Surface Defined By 8 Coordinate Points

Point No.	X-Surf (ft)	Y-Surf (ft)
1	161.90	145.67
2	174.83	135.63
3	215.99	153.93
4	340.88	196.50
5	368.92	207.43
6	380.27	213.09
7	399.30	225.09
8	415.12	250.00

Factor Of Safety For The Preceding Specified Surface = -3.209

The Factor Of Safety For The Trial Failure Surface Defined

By The Coordinates Listed Below Is Misleading.

Failure Surface Defined By 9 Coordinate Points

Point No.	X-Surf (ft)	Y-Surf (ft)
1	80.90	134.06
2	81.68	133.86
3	127.85	114.68
4	215.00	150.06
5	340.87	197.44
6	367.19	209.68
7	380.17	213.16
8	391.50	219.92

9 416.27 250.00
 Factor Of Safety For The Preceding Specified Surface = -1.633
 The Factor Of Safety For The Trial Failure Surface Defined
 By The Coordinates Listed Below Is Misleading.
 Failure Surface Defined By 8 Coordinate Points

Point No.	X-Surf (ft)	Y-Surf (ft)
1	114.64	136.30
2	134.92	116.47
3	215.62	151.83
4	339.48	195.70
5	368.70	208.80
6	380.59	216.51
7	392.14	222.17
8	415.97	250.00

Factor Of Safety For The Preceding Specified Surface = -2.178
 The Factor Of Safety For The Trial Failure Surface Defined
 By The Coordinates Listed Below Is Misleading.
 Failure Surface Defined By 8 Coordinate Points

Point No.	X-Surf (ft)	Y-Surf (ft)
1	205.93	158.05
2	212.30	151.84
3	215.41	150.97
4	339.55	197.55
5	367.94	208.12
6	380.74	214.05
7	393.33	221.23
8	416.47	250.00

Factor Of Safety For The Preceding Specified Surface = -1.633
 The Factor Of Safety For The Trial Failure Surface Defined
 By The Coordinates Listed Below Is Misleading.
 Failure Surface Defined By 9 Coordinate Points

Point No.	X-Surf (ft)	Y-Surf (ft)
1	48.69	127.39
2	60.16	125.62
3	105.03	103.55
4	215.20	151.87
5	339.06	197.85
6	367.74	210.43
7	380.32	214.00
8	393.68	223.60
9	418.14	250.00

Factor Of Safety For The Preceding Specified Surface = -6.037
 The Factor Of Safety For The Trial Failure Surface Defined
 By The Coordinates Listed Below Is Misleading.
 Failure Surface Defined By 8 Coordinate Points

Point No.	X-Surf (ft)	Y-Surf (ft)
1	164.56	146.93
2	194.26	141.39
3	214.72	151.93
4	340.18	195.45
5	367.66	208.46
6	380.02	214.32
7	399.67	225.82
8	414.90	250.00

Factor Of Safety For The Preceding Specified Surface = -2.182
 The Factor Of Safety For The Trial Failure Surface Defined
 By The Coordinates Listed Below Is Misleading.
 Failure Surface Defined By 8 Coordinate Points

Point No.	X-Surf (ft)	Y-Surf (ft)
1	203.96	157.42
2	210.40	151.02
3	215.18	152.70

4	339.99	195.75
5	368.93	207.54
6	380.94	213.44
7	391.69	220.59
8	418.03	250.00

Factor Of Safety For The Preceding Specified Surface = -5.187
 The Factor Of Safety For The Trial Failure Surface Defined
 By The Coordinates Listed Below Is Misleading.
 Failure Surface Defined By 8 Coordinate Points

Point No.	X-Surf (ft)	Y-Surf (ft)
1	201.03	156.47
2	208.09	149.60
3	215.36	150.34
4	339.05	198.50
5	367.77	208.95
6	380.84	213.57
7	392.43	222.35
8	418.26	250.00

Factor Of Safety For The Preceding Specified Surface = -3.366
 The Factor Of Safety For The Trial Failure Surface Defined
 By The Coordinates Listed Below Is Misleading.
 Failure Surface Defined By 8 Coordinate Points

Point No.	X-Surf (ft)	Y-Surf (ft)
1	193.17	153.95
2	204.36	148.56
3	215.36	153.28
4	339.44	195.89
5	367.36	209.92
6	380.88	216.24
7	394.69	222.88
8	417.72	250.00

Factor Of Safety For The Preceding Specified Surface = -5.803
 The Factor Of Safety For The Trial Failure Surface Defined
 By The Coordinates Listed Below Is Misleading.
 Failure Surface Defined By 8 Coordinate Points

Point No.	X-Surf (ft)	Y-Surf (ft)
1	167.23	148.21
2	179.37	137.55
3	214.97	151.43
4	340.48	197.52
5	368.80	207.41
6	380.02	216.97
7	400.49	223.84
8	413.19	250.00

Factor Of Safety For The Preceding Specified Surface = -2.274
 The Factor Of Safety For The Trial Failure Surface Defined
 By The Coordinates Listed Below Is Misleading.
 Failure Surface Defined By 8 Coordinate Points

Point No.	X-Surf (ft)	Y-Surf (ft)
1	124.27	136.97
2	145.50	120.84
3	214.41	152.75
4	339.63	196.59
5	368.15	210.40
6	380.40	213.58
7	390.32	218.64
8	415.31	250.00

Factor Of Safety For The Preceding Specified Surface = -4.014
 WARNING! The factor of safety calculation did not converge in 20 iterations.
 The Trial Failure Surface In Question Is Defined
 By The Following 8 Coordinate Points

Point No.	X-Surf (ft)	Y-Surf (ft)
-----------	-------------	-------------

1	163.06	146.22
2	177.23	133.97
3	214.60	151.51
4	340.10	195.25
5	368.50	207.22
6	380.84	216.80
7	395.88	221.04
8	412.67	250.00

Factor of Safety for the Preceding Surface is Between-0.370 and-0.537
 The Factor Of Safety For The Trial Failure Surface Defined
 By The Coordinates Listed Below Is Misleading.
 Failure Surface Defined By 8 Coordinate Points

Point No.	X-Surf (ft)	Y-Surf (ft)
1	160.25	144.88
2	173.44	132.32

SOME LINES SKIPPED

Following Are Displayed The Ten Most Critical Of The Trial
 Failure Surfaces Evaluated. They Are
 Ordered - Most Critical First.

* * Safety Factors Are Calculated By The Simplified Janbu Method * *

Total Number of Trial Surfaces Attempted = 8000

WARNING! The Factor of Safety Calculation for one or More Trial Surfaces
 Did Not Converge in 20 Iterations.

Number of Trial Surfaces with Non-Converged FS = 165

Number of Trial Surfaces with Misleading FS = 666

Number of Trial Failure Surfaces is Greater Than 5000.

Statistical Data on FS Values are Not Generated.

To Generate Stastical Data, Reduce Number of Trial

Failure Surfaces to 5000 or less.

Failure Surface Specified By 8 Coordinate Points

Point No.	X-Surf (ft)	Y-Surf (ft)
1	179.428	150.648
2	198.630	145.473
3	214.233	150.995
4	339.228	197.493
5	368.684	210.038
6	380.848	214.505
7	395.215	224.139
8	406.967	250.000

Factor of Safety
 *** 1.149 ***

Individual data on the 25 slices

Slice No.	Width (ft)	Weight (lbs)	Water Force		Tie Force		Earthquake Force		
			Top (lbs)	Bot (lbs)	Norm (lbs)	Tan (lbs)	Hor (lbs)	Ver (lbs)	Surcharge Load (lbs)
1	4.6	470.7	0.0	0.0	0.	0.	0.0	0.0	0.0
2	14.2	10691.7	0.0	0.0	0.	0.	0.0	0.0	0.0
3	0.4	541.5	0.0	0.0	0.	0.	0.0	0.0	0.0
4	13.4	17402.3	0.0	0.0	0.	0.	0.0	0.0	0.0
5	2.2	2883.7	0.0	0.0	0.	0.	0.0	0.0	0.0
6	0.8	1009.5	0.0	0.0	0.	0.	0.0	0.0	0.0
7	47.0	77583.1	0.0	0.0	0.	0.	0.0	0.0	0.0
8	18.0	44197.5	0.0	0.0	0.	0.	0.0	0.0	0.0
9	25.0	84142.2	0.0	0.0	0.	0.	0.0	0.0	0.0
10	12.0	46812.4	0.0	0.0	0.	0.	0.0	0.0	0.0
11	20.0	79445.6	0.0	0.0	0.	0.	0.0	0.0	0.0
12	2.2	8792.2	0.0	0.0	0.	0.	0.0	0.0	0.0
13	0.8	3044.2	0.0	0.0	0.	0.	0.0	0.0	0.0
14	10.0	39163.7	0.0	0.0	0.	0.	0.0	0.0	0.0
15	15.0	59914.7	0.0	0.0	0.	0.	0.0	0.0	0.0
16	3.0	12325.2	0.0	0.0	0.	0.	0.0	0.0	0.0
17	0.7	2819.8	0.0	0.0	0.	0.	0.0	0.0	0.0
18	12.2	51159.7	0.0	0.0	0.	0.	0.0	0.0	0.0
19	0.2	653.6	0.0	0.0	0.	0.	0.0	0.0	0.0

20	3.0	12744.0	0.0	0.0	0.	0.	0.0	0.0	0.0
21	5.0	20283.3	0.0	0.0	0.	0.	0.0	0.0	0.0
22	0.2	655.4	0.0	0.0	0.	0.	0.0	0.0	0.0
23	6.0	21921.5	0.0	0.0	0.	0.	0.0	0.0	0.0
24	4.0	11218.8	0.0	0.0	0.	0.	0.0	0.0	0.0
25	7.7	8536.4	0.0	0.0	0.	0.	0.0	0.0	0.0

Failure Surface Specified By 8 Coordinate Points

Point No.	X-Surf (ft)	Y-Surf (ft)
1	179.428	150.648
2	198.630	145.473
3	214.233	150.995
4	339.228	197.493
5	368.684	210.038
6	380.848	214.505
7	395.215	224.139
8	406.967	250.000

Factor of Safety
 *** 1.149 ***

Failure Surface Specified By 8 Coordinate Points

Point No.	X-Surf (ft)	Y-Surf (ft)
1	179.428	150.648
2	198.630	145.473
3	214.233	150.995
4	339.228	197.493
5	368.684	210.038
6	380.848	214.505
7	395.215	224.139
8	406.967	250.000

Factor of Safety
 *** 1.149 ***

Failure Surface Specified By 8 Coordinate Points

Point No.	X-Surf (ft)	Y-Surf (ft)
1	179.428	150.648
2	198.630	145.473
3	214.233	150.995
4	339.228	197.493
5	368.684	210.038
6	380.848	214.505
7	395.215	224.139
8	406.967	250.000

Factor of Safety
 *** 1.149 ***

Failure Surface Specified By 8 Coordinate Points

Point No.	X-Surf (ft)	Y-Surf (ft)
1	179.428	150.648
2	198.630	145.473
3	214.233	150.995
4	339.228	197.493
5	368.684	210.038
6	380.848	214.505
7	395.215	224.139
8	406.967	250.000

Factor of Safety
 *** 1.149 ***

Failure Surface Specified By 8 Coordinate Points

Point No.	X-Surf (ft)	Y-Surf (ft)
1	179.428	150.648
2	198.630	145.473
3	214.233	150.995
4	339.228	197.493
5	368.684	210.038
6	380.848	214.505

7	395.215	224.139
8	406.967	250.000
Factor of Safety		
***	1.149	***
Failure Surface Specified By 8 Coordinate Points		
Point	X-Surf	Y-Surf
No.	(ft)	(ft)
1	179.428	150.648
2	198.630	145.473
3	214.233	150.995
4	339.228	197.493
5	368.684	210.038
6	380.848	214.505
7	395.215	224.139
8	406.967	250.000
Factor of Safety		
***	1.149	***
Failure Surface Specified By 8 Coordinate Points		
Point	X-Surf	Y-Surf
No.	(ft)	(ft)
1	179.428	150.648
2	198.630	145.473
3	214.233	150.995
4	339.228	197.493
5	368.684	210.038
6	380.848	214.505
7	395.215	224.139
8	406.967	250.000
Factor of Safety		
***	1.149	***
Failure Surface Specified By 8 Coordinate Points		
Point	X-Surf	Y-Surf
No.	(ft)	(ft)
1	179.428	150.648
2	198.630	145.473
3	214.233	150.995
4	339.228	197.493
5	368.684	210.038
6	380.848	214.505
7	395.215	224.139
8	406.967	250.000
Factor of Safety		
***	1.149	***
Failure Surface Specified By 8 Coordinate Points		
Point	X-Surf	Y-Surf
No.	(ft)	(ft)
1	179.428	150.648
2	198.630	145.473
3	214.233	150.995
4	339.228	197.493
5	368.684	210.038
6	380.848	214.505
7	395.215	224.139
8	406.967	250.000
Factor of Safety		
***	1.149	***
**** END OF GSTABL7 OUTPUT ****		

I-I' / Alt Design / Search Along Rupture/ Outside PL (Block)

z:\2010\10132-01 south shores church - dana point\engineering\2013_01\i1_1.pl2 Run By: Username 1/15/2013 03:09PM

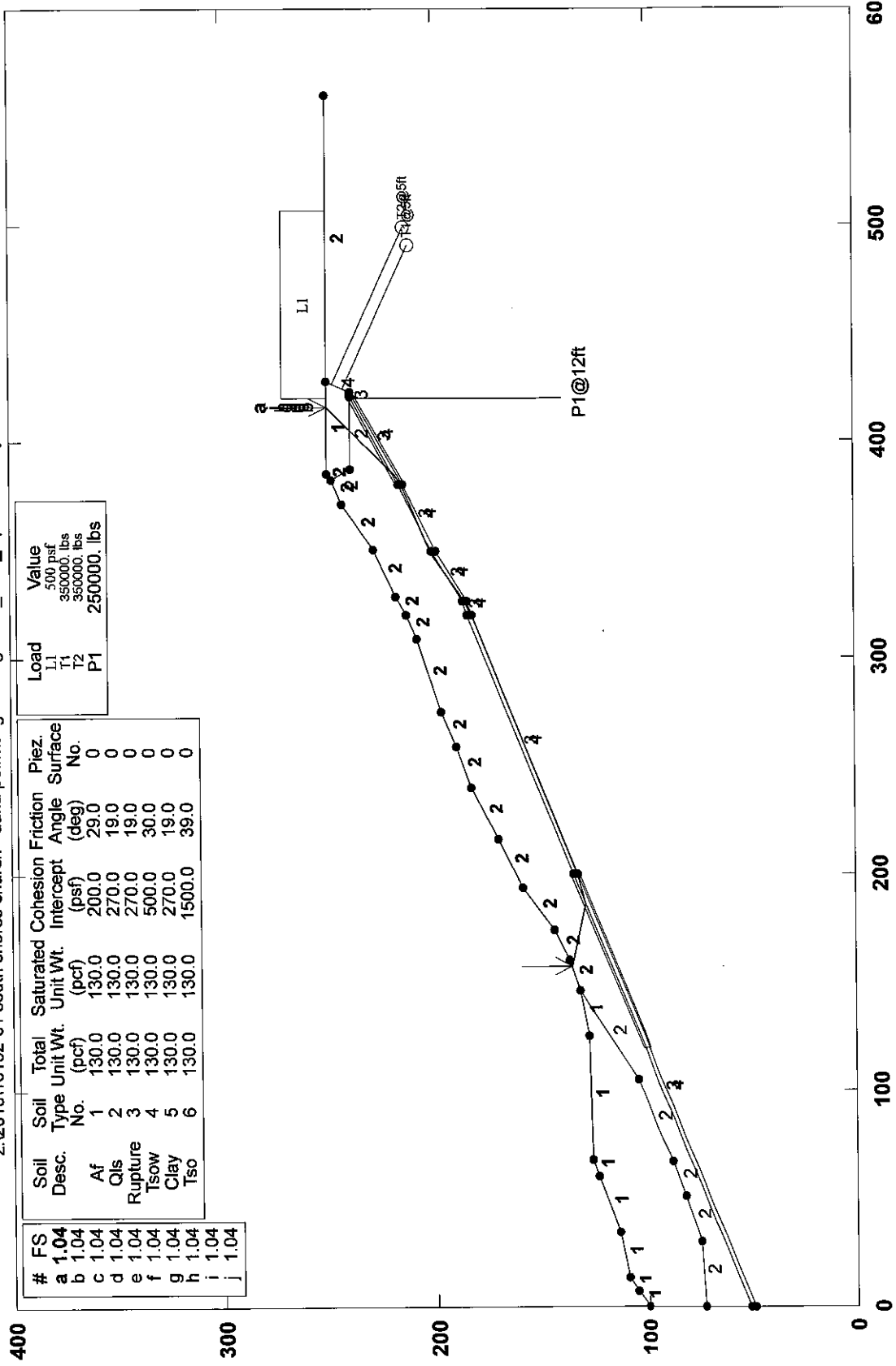

Load	Value
L1	500 psf
T1	350000 lbs
T2	350000 lbs
P1	250000 lbs

#	FS	Soil Desc.	Soil Type No.	Total Unit Wt. (pcf)	Saturated Unit Wt. (pcf)	Cohesion Intercept (psf)	Friction Angle (deg)	Piez. Surface No.
a	1.04	Af	1	130.0	130.0	200.0	29.0	0
b	1.04	Qls	2	130.0	130.0	270.0	19.0	0
c	1.04	Rupture	3	130.0	130.0	270.0	19.0	0
d	1.04	Tsow	4	130.0	130.0	500.0	30.0	0
e	1.04	Clay	5	130.0	130.0	270.0	19.0	0
f	1.04	Tso	6	130.0	130.0	1500.0	39.0	0
g	1.04							
h	1.04							
i	1.04							
j	1.04							

GSTABL7 v.2 FSmin=1.04

Safety Factors Are Calculated By The Simplified Janbu Method for the case of c & phi both > 0

*** GSTABL7 ***

** GSTABL7 by Dr. Garry H. Gregory, Ph.D., P.E., D.GE **
 ** Original Version 1.0, January 1996; Current Ver. 2.005.2, Jan. 2011 **
 (All Rights Reserved-Unauthorized Use Prohibited)

SLOPE STABILITY ANALYSIS SYSTEM

Modified Bishop, Simplified Janbu, or GLE Method of Slices.
 (Includes Spencer & Morgenstern-Price Type Analysis)
 Including Pier/Pile, Reinforcement, Soil Nail, Tieback,
 Nonlinear Undrained Shear Strength, Curved Phi Envelope,
 Anisotropic Soil, Fiber-Reinforced Soil, Boundary Loads, Water
 Surfaces, Pseudo-Static & Newmark Earthquake, and Applied Forces.

Analysis Run Date: 1/15/2013
 Time of Run: 03:09PM
 Run By: Username
 Input Data Filename: Z:\2010\10132-01 South Shores Church - Dana Point\Engineering\2013_01\ii'_1.
 Output Filename: Z:\2010\10132-01 South Shores Church - Dana Point\Engineering\2013_01\ii'_1.OUT
 Unit System: English
 Plotted Output Filename: Z:\2010\10132-01 South Shores Church - Dana Point\Engineering\2013_01\ii'_1.PLT
 PROBLEM DESCRIPTION: I-I' / Alt Design / Search Along Rupture / Outside PL (Block)

BOUNDARY COORDINATES
 23 Top Boundaries
 44 Total Boundaries

Boundary No.	X-Left (ft)	Y-Left (ft)	X-Right (ft)	Y-Right (ft)	Soil Type Below Bnd
1	0.00	100.00	7.00	106.00	1
2	7.00	106.00	13.00	110.00	1
3	13.00	110.00	34.00	114.00	1
4	34.00	114.00	60.00	124.00	1
5	60.00	124.00	68.00	127.00	1
6	68.00	127.00	125.00	128.00	1
7	125.00	128.00	146.00	132.00	1
8	146.00	132.00	160.00	137.00	2
9	160.00	137.00	174.00	144.00	2
10	174.00	144.00	194.00	159.00	2
11	194.00	159.00	216.00	170.00	2
12	216.00	170.00	240.00	183.00	2
13	240.00	183.00	259.00	190.00	2
14	259.00	190.00	275.00	197.00	2
15	275.00	197.00	309.00	208.00	2
16	309.00	208.00	320.00	213.00	2
17	320.00	213.00	328.00	218.00	2
18	328.00	218.00	350.00	228.00	2
19	350.00	228.00	371.00	243.00	2
20	371.00	243.00	382.00	248.00	2
21	382.00	248.00	385.00	250.00	2
22	385.00	250.00	428.00	250.00	1
23	428.00	250.00	560.00	250.00	2
24	0.00	73.00	30.00	75.00	2
25	30.00	75.00	51.00	82.00	2
26	51.00	82.00	67.00	88.00	2
27	67.00	88.00	105.00	105.00	2
28	105.00	105.00	146.00	132.00	2
29	382.00	248.00	387.00	239.00	2
30	387.00	239.00	421.00	239.00	2
31	421.00	239.00	423.00	239.00	3
32	423.00	239.00	428.00	250.00	4
33	0.00	51.00	200.00	135.00	3
34	200.00	135.00	320.00	184.00	3
35	320.00	184.00	326.00	186.00	3
36	326.00	186.00	349.00	201.00	3
37	349.00	201.00	380.00	216.00	3
38	380.00	216.00	421.00	239.00	3

39	0.00	49.00	200.00	133.00	4
40	200.00	133.00	320.00	182.00	4
41	320.00	182.00	326.00	184.00	4
42	326.00	184.00	349.00	199.00	4
43	349.00	199.00	380.00	214.00	4
44	380.00	214.00	423.00	239.00	4

Default Y-Origin = 0.00(ft)
 Default X-Plus Value = 0.00(ft)
 Default Y-Plus Value = 0.00(ft)

ISOTROPIC SOIL PARAMETERS

6 Type(s) of Soil

Soil Type No.	Total Unit Wt. (pcf)	Saturated Unit Wt. (pcf)	Cohesion Intercept (psf)	Friction Angle (deg)	Pore Pressure Param. (psf)	Pressure Constant (psf)	Piez. Surface No.
1	130.0	130.0	200.0	29.0	0.00	0.0	0
2	130.0	130.0	270.0	19.0	0.00	0.0	0
3	130.0	130.0	270.0	19.0	0.00	0.0	0
4	130.0	130.0	500.0	30.0	0.00	0.0	0
5	130.0	130.0	270.0	19.0	0.00	0.0	0
6	130.0	130.0	1500.0	39.0	0.00	0.0	0

BOUNDARY LOAD(S)

1 Load(s) Specified

Load No.	X-Left (ft)	X-Right (ft)	Intensity (psf)	Deflection (deg)
1	420.00	507.00	500.0	0.0

NOTE - Intensity Is Specified As A Uniformly Distributed Force Acting On A Horizontally Projected Surface.

TIEBACK LOAD(S)

2 Tieback Load(s) Specified

Tieback No.	X-Pos (ft)	Y-Pos (ft)	Load (lbs)	Spacing (ft)	Inclination (deg)	Length (ft)	Force Method
1	424.36	242.00	350000.0	5.0	25.00	73.0	2
2	426.64	247.00	350000.0	5.0	25.00	80.0	2

NOTE - An Equivalent Line Load Is Calculated For Each Row Of Tiebacks Assuming A Uniform Distribution Of Load Horizontally Between Individual Tiebacks. Force Method 1 Considers Only Tangential Tieback Forces. Force Method 2 Considers Both Tangential and Normal Tieback Forces. Force Method 3 Considers Only Normal Tieback Forces. Force Method 4 Limits Normal and Tangential Tieback-Force Distribution to 1.5 Times the Tieback Inclination, or to 30 Degrees Below (Left of) the Tieback-Failure Surface Intersection, Whichever is Greater.

PIER/PILE LOAD(S)

1 Pier/Pile Load(s) Specified

Pier/Pile No.	X-Pos (ft)	Y-Pos (ft)	Load (lbs)	Spacing (ft)	Inclination (deg)	Length (ft)
1	420.00	239.00	250000.0	12.0	90.00	100.0

NOTE - An Equivalent Line Load Is Calculated For Each Row Of Piers/Piles Assuming A Uniform Distribution Of Load Horizontally Between Individual Piers/Piles.

Janbus Empirical Coef is being used for the case of c & phi both > 0
 A Critical Failure Surface Searching Method, Using A Random Technique For Generating Sliding Block Surfaces, Has Been Specified.

8000 Trial Surfaces Have Been Generated.

7 Boxes Specified For Generation Of Central Block Base

Length Of Line Segments For Active And Passive Portions Of Sliding Block Is 50.0

Box No.	X-Left (ft)	Y-Left (ft)	X-Right (ft)	Y-Right (ft)	Height (ft)
1	120.00	100.40	199.00	133.60	4.00
2	199.10	134.00	201.00	134.00	4.00
3	319.00	183.00	321.00	183.00	4.00
4	325.00	185.00	327.00	185.00	4.00
5	348.00	200.00	350.00	200.00	4.00
6	379.00	215.00	381.00	215.00	4.00
7	381.10	215.60	422.00	239.00	4.00

The Factor Of Safety For The Trial Failure Surface Defined

By The Coordinates Listed Below Is Misleading.
 Failure Surface Defined By 9 Coordinate Points

Point No.	X-Surf (ft)	Y-Surf (ft)
1	170.83	142.41
2	185.98	128.64
3	199.83	133.07
4	319.96	182.35
5	325.17	184.75
6	349.84	201.63
7	379.91	216.37
8	418.17	235.16
9	431.81	250.00

Factor Of Safety For The Preceding Specified Surface = -38.890

The Factor Of Safety For The Trial Failure Surface Defined
 By The Coordinates Listed Below Is Misleading.

Failure Surface Defined By 9 Coordinate Points

Point No.	X-Surf (ft)	Y-Surf (ft)
1	123.04	127.97
2	140.86	110.14
3	199.37	134.94
4	320.29	183.71
5	326.72	186.14
6	349.27	198.12
7	380.13	213.53
8	421.50	238.94
9	428.56	250.00

Factor Of Safety For The Preceding Specified Surface = -1.632

The Factor Of Safety For The Trial Failure Surface Defined
 By The Coordinates Listed Below Is Misleading.

Failure Surface Defined By 9 Coordinate Points

Point No.	X-Surf (ft)	Y-Surf (ft)
1	153.61	134.72
2	167.13	121.54
3	200.52	135.81
4	319.10	184.72
5	326.69	183.92
6	348.47	198.29
7	379.11	214.71
8	418.16	234.86
9	431.33	250.00

Factor Of Safety For The Preceding Specified Surface = -9.247

Following Are Displayed The Ten Most Critical Of The Trial

Failure Surfaces Evaluated. They Are
 Ordered - Most Critical First.

* * Safety Factors Are Calculated By The Simplified Janbu Method * *

Total Number of Trial Surfaces Attempted = 8000

Number of Trial Surfaces with Misleading FS = 3

Number of Trial Failure Surfaces is Greater Than 5000.

Statistical Data on FS Values are Not Generated.

To Generate Stastical Data, Reduce Number of Trial

Failure Surfaces to 5000 or less.

Failure Surface Specified By 9 Coordinate Points

Point No.	X-Surf (ft)	Y-Surf (ft)
1	157.508	136.110
2	186.285	129.473
3	199.662	132.894
4	320.090	182.306
5	326.113	185.828
6	348.096	200.834
7	379.978	214.699
8	385.102	218.688
9	415.632	250.000

Factor of Safety

*** 1.044 ***

Slice No.	Width (ft)	Weight (lbs)	Individual data on the		31 slices		Earthquake		
			Water Force Top	Water Force Bot	Tie Force Norm	Tie Force Tan	Force Hor	Force Ver	Surcharge Load
			(lbs)	(lbs)	(lbs)	(lbs)	(lbs)	(lbs)	(lbs)
1	2.5	237.3	0.0	0.0	0.	0.	0.0	0.0	0.0
2	14.0	11974.3	0.0	0.0	0.	0.	0.0	0.0	0.0
3	12.3	28295.2	0.0	0.0	0.	0.	0.0	0.0	0.0
4	1.4	4449.6	0.0	0.0	0.	0.	0.0	0.0	0.0
5	6.3	21273.4	0.0	0.0	0.	0.	0.0	0.0	0.0
6	5.7	20788.8	0.0	0.0	0.	0.	0.0	0.0	0.0
7	0.3	1273.5	0.0	0.0	0.	0.	0.0	0.0	0.0
8	16.0	61743.7	0.0	0.0	0.	0.	0.0	0.0	0.0
9	24.0	99772.7	0.0	0.0	0.	0.	0.0	0.0	0.0
10	19.0	81897.6	0.0	0.0	0.	0.	0.0	0.0	0.0
11	16.0	68591.4	0.0	0.0	0.	0.	0.0	0.0	0.0
12	34.0	140198.4	0.0	0.0	0.	0.	0.0	0.0	0.0
13	11.0	43596.8	0.0	0.0	0.	0.	0.0	0.0	0.0
14	0.1	360.5	0.0	0.0	0.	0.	0.0	0.0	0.0
15	5.9	23715.8	0.0	0.0	0.	0.	0.0	0.0	0.0
16	0.1	453.9	0.0	0.0	0.	0.	0.0	0.0	0.0
17	1.9	7590.8	0.0	0.0	0.	0.	0.0	0.0	0.0
18	6.2	24264.2	0.0	0.0	0.	0.	0.0	0.0	0.0
19	13.9	50432.9	0.0	0.0	0.	0.	0.0	0.0	0.0
20	1.9	6514.4	0.0	0.0	0.	0.	0.0	0.0	0.0
21	3.6	12675.1	0.0	0.0	0.	0.	0.0	0.0	0.0
22	17.4	67237.1	0.0	0.0	0.	0.	0.0	0.0	0.0
23	9.0	37690.9	0.0	0.0	0.	0.	0.0	0.0	0.0
24	0.0	93.0	0.0	0.0	0.	0.	0.0	0.0	0.0
25	2.0	8333.2	0.0	0.0	0.	0.	0.0	0.0	0.0
26	3.0	12308.0	0.0	0.0	0.	0.	0.0	0.0	0.0
27	0.1	414.2	0.0	0.0	0.	0.	0.0	0.0	0.0
28	0.4	1513.8	0.0	0.0	0.	0.	0.0	0.0	0.0
29	1.5	5973.4	0.0	0.0	0.	0.	0.0	0.0	0.0
30	17.9	46981.0	0.0	0.0	0.	0.	0.0	0.0	0.0
31	10.7	7668.6	0.0	0.0	0.	0.	0.0	0.0	0.0

Failure Surface Specified By 9 Coordinate Points

Point No.	X-Surf (ft)	Y-Surf (ft)
1	157.508	136.110
2	186.285	129.473
3	199.662	132.894
4	320.090	182.306
5	326.113	185.828
6	348.096	200.834
7	379.978	214.699
8	385.102	218.688
9	415.632	250.000

Factor of Safety

*** 1.044 ***

Failure Surface Specified By 9 Coordinate Points

Point No.	X-Surf (ft)	Y-Surf (ft)
1	157.508	136.110
2	186.285	129.473
3	199.662	132.894
4	320.090	182.306
5	326.113	185.828
6	348.096	200.834
7	379.978	214.699
8	385.102	218.688
9	415.632	250.000

Factor of Safety

*** 1.044 ***

Failure Surface Specified By 9 Coordinate Points

Point	X-Surf	Y-Surf
-------	--------	--------

No.	(ft)	(ft)
1	157.508	136.110
2	186.285	129.473
3	199.662	132.894
4	320.090	182.306
5	326.113	185.828
6	348.096	200.834
7	379.978	214.699
8	385.102	218.688
9	415.632	250.000

Factor of Safety
 *** 1.044 ***

Failure Surface Specified By 9 Coordinate Points

Point	X-Surf	Y-Surf
No.	(ft)	(ft)
1	157.508	136.110
2	186.285	129.473
3	199.662	132.894
4	320.090	182.306
5	326.113	185.828
6	348.096	200.834
7	379.978	214.699
8	385.102	218.688
9	415.632	250.000

Factor of Safety
 *** 1.044 ***

Failure Surface Specified By 9 Coordinate Points

Point	X-Surf	Y-Surf
No.	(ft)	(ft)
1	157.508	136.110
2	186.285	129.473
3	199.662	132.894
4	320.090	182.306
5	326.113	185.828
6	348.096	200.834
7	379.978	214.699
8	385.102	218.688
9	415.632	250.000

Factor of Safety
 *** 1.044 ***

Failure Surface Specified By 9 Coordinate Points

Point	X-Surf	Y-Surf
No.	(ft)	(ft)
1	157.508	136.110
2	186.285	129.473
3	199.662	132.894
4	320.090	182.306
5	326.113	185.828
6	348.096	200.834
7	379.978	214.699
8	385.102	218.688
9	415.632	250.000

Factor of Safety
 *** 1.044 ***

Failure Surface Specified By 9 Coordinate Points

Point	X-Surf	Y-Surf
No.	(ft)	(ft)
1	157.508	136.110
2	186.285	129.473
3	199.662	132.894
4	320.090	182.306
5	326.113	185.828
6	348.096	200.834
7	379.978	214.699
8	385.102	218.688
9	415.632	250.000

Factor of Safety

*** 1.044 ***
Failure Surface Specified By 9 Coordinate Points

Point No.	X-Surf (ft)	Y-Surf (ft)
1	157.508	136.110
2	186.285	129.473
3	199.662	132.894
4	320.090	182.306
5	326.113	185.828
6	348.096	200.834
7	379.978	214.699
8	385.102	218.688
9	415.632	250.000

Factor of Safety
*** 1.044 ***
Failure Surface Specified By 9 Coordinate Points

Point No.	X-Surf (ft)	Y-Surf (ft)
1	157.508	136.110
2	186.285	129.473
3	199.662	132.894
4	320.090	182.306
5	326.113	185.828
6	348.096	200.834
7	379.978	214.699
8	385.102	218.688
9	415.632	250.000

Factor of Safety
*** 1.044 ***
**** END OF GSTABL7 OUTPUT ****

Appendix E
General Earthwork and Grading Specifications
for Rough Grading

General Earthwork and Grading Specifications for Rough Grading

1.0 *General*

1.1 *Intent:* These General Earthwork and Grading Specifications are for the grading and earthwork shown on the approved grading plan(s) and/or indicated in the geotechnical report(s). These Specifications are a part of the recommendations contained in the geotechnical report(s). In case of conflict, the specific recommendations in the geotechnical report shall supersede these more general Specifications. Observations of the earthwork by the project Geotechnical Consultant during the course of grading may result in new or revised recommendations that could supersede these specifications or the recommendations in the geotechnical report(s).

1.2 *The Geotechnical Consultant of Record:* Prior to commencement of work, the owner shall employ a qualified Geotechnical Consultant of Record (Geotechnical Consultant). The Geotechnical Consultant shall be responsible for reviewing the approved geotechnical report(s) and accepting the adequacy of the preliminary geotechnical findings, conclusions, and recommendations prior to the commencement of the grading.

Prior to commencement of grading, the Geotechnical Consultant shall review the "work plan" prepared by the Earthwork Contractor (Contractor) and schedule sufficient personnel to perform the appropriate level of observation, mapping, and compaction testing.

During the grading and earthwork operations, the Geotechnical Consultant shall observe, map, and document the subsurface exposures to verify the geotechnical design assumptions. If the observed conditions are found to be significantly different than the interpreted assumptions during the design phase, the Geotechnical Consultant shall inform the owner, recommend appropriate changes in design to accommodate the observed conditions, and notify the review agency where required.

The Geotechnical Consultant shall observe the moisture-conditioning and processing of the subgrade and fill materials and perform relative compaction testing of fill to confirm that the attained level of compaction is being accomplished as specified. The Geotechnical Consultant shall provide the test results to the owner and the Contractor on a routine and frequent basis.

1.3 *The Earthwork Contractor:* The Earthwork Contractor (Contractor) shall be qualified, experienced, and knowledgeable in earthwork logistics, preparation and processing of ground to receive fill, moisture-conditioning and processing of fill, and compacting fill. The Contractor shall review and accept the plans, geotechnical report(s), and these Specifications prior to commencement of grading. The Contractor shall be solely responsible for performing the grading in accordance with the project plans and specifications. The Contractor shall prepare and submit to the owner and the Geotechnical Consultant a work plan that indicates the sequence of earthwork grading, the number of "equipment" of work and the estimated quantities of daily earthwork contemplated for the site prior to commencement of grading. The Contractor shall inform the owner and the

Geotechnical Consultant of changes in work schedules and updates to the work plan at least 24 hours in advance of such changes so that appropriate personnel will be available for observation and testing. The Contractor shall not assume that the Geotechnical Consultant is aware of all grading operations.

The Contractor shall have the sole responsibility to provide adequate equipment and methods to accomplish the earthwork in accordance with the applicable grading codes and agency ordinances, these Specifications, and the recommendations in the approved geotechnical report(s) and grading plan(s). If, in the opinion of the Geotechnical Consultant, unsatisfactory conditions, such as unsuitable soil, improper moisture condition, inadequate compaction, insufficient buttress key size, adverse weather, etc., are resulting in a quality of work less than required in these specifications, the Geotechnical Consultant shall reject the work and may recommend to the owner that construction be stopped until the conditions are rectified. It is the contractor's sole responsibility to provide proper fill compaction.

2.0 Preparation of Areas to be Filled

2.1 Clearing and Grubbing: Vegetation, such as brush, grass, roots, and other deleterious material shall be sufficiently removed and properly disposed of in a method acceptable to the owner, governing agencies, and the Geotechnical Consultant.

The Geotechnical Consultant shall evaluate the extent of these removals depending on specific site conditions. Earth fill material shall not contain more than 1 percent of organic materials (by volume). Nesting of the organic materials shall not be allowed.

If potentially hazardous materials are encountered, the Contractor shall stop work in the affected area, and a hazardous material specialist shall be informed immediately for proper evaluation and handling of these materials prior to continuing to work in that area.

As presently defined by the State of California, most refined petroleum products (gasoline, diesel fuel, motor oil, grease, coolant, etc.) have chemical constituents that are considered to be hazardous waste. As such, the indiscriminate dumping or spillage of these fluids onto the ground may constitute a misdemeanor, punishable by fines and/or imprisonment, and shall not be allowed. The contractor is responsible for all hazardous waste relating to his work. The Geotechnical Consultant does not have expertise in this area. If hazardous waste is a concern, then the Client should acquire the services of a qualified environmental assessor.

2.2 Processing: Existing ground that has been declared satisfactory for support of fill by the Geotechnical Consultant shall be scarified to a minimum depth of 6 inches. Existing ground that is not satisfactory shall be overexcavated as specified in the following section. Scarification shall continue until soils are broken down and free of oversize material and the working surface is reasonably uniform, flat, and free of uneven features that would inhibit uniform compaction.

2.3 Overexcavation: In addition to removals and overexcavations recommended in the approved geotechnical report(s) and the grading plan, soft, loose, dry, saturated, spongy,

organic-rich, highly fractured or otherwise unsuitable ground shall be overexcavated to competent ground as evaluated by the Geotechnical Consultant during grading.

2.4 **Benching:** Where fills are to be placed on ground with slopes steeper than 5:1 (horizontal to vertical units), the ground shall be stepped or benched. Please see the Standard Details for a graphic illustration. The lowest bench or key shall be a minimum of 15 feet wide and at least 2 feet deep, into competent material as evaluated by the Geotechnical Consultant. Other benches shall be excavated a minimum height of 4 feet into competent material or as otherwise recommended by the Geotechnical Consultant. Fill placed on ground sloping flatter than 5:1 shall also be benched or otherwise overexcavated to provide a flat subgrade for the fill.

2.5 **Evaluation/Acceptance of Fill Areas:** All areas to receive fill, including removal and processed areas, key bottoms, and benches, shall be observed, mapped, elevations recorded, and/or tested prior to being accepted by the Geotechnical Consultant as suitable to receive fill. The Contractor shall obtain a written acceptance from the Geotechnical Consultant prior to fill placement. A licensed surveyor shall provide the survey control for determining elevations of processed areas, keys, and benches.

3.0 **Fill Material**

3.1 **General:** Material to be used as fill shall be essentially free of organic matter and other deleterious substances evaluated and accepted by the Geotechnical Consultant prior to placement. Soils of poor quality, such as those with unacceptable gradation, high expansion potential, or low strength shall be placed in areas acceptable to the Geotechnical Consultant or mixed with other soils to achieve satisfactory fill material.

3.2 **Oversize:** Oversize material defined as rock, or other irreducible material with a maximum dimension greater than 8 inches, shall not be buried or placed in fill unless location, materials, and placement methods are specifically accepted by the Geotechnical Consultant. Placement operations shall be such that nesting of oversized material does not occur and such that oversize material is completely surrounded by compacted or densified fill. Oversize material shall not be placed within 10 vertical feet of finish grade or within 2 feet of future utilities or underground construction.

3.3 **Import:** If importing of fill material is required for grading, proposed import material shall meet the requirements of the geotechnical consultant. The potential import source shall be given to the Geotechnical Consultant at least 48 hours (2 working days) before importing begins so that its suitability can be determined and appropriate tests performed.

4.0 Fill Placement and Compaction

- 4.1 Fill Layers:** Approved fill material shall be placed in areas prepared to receive fill (per Section 3.0) in near-horizontal layers not exceeding 8 inches in loose thickness. The Geotechnical Consultant may accept thicker layers if testing indicates the grading procedures can adequately compact the thicker layers. Each layer shall be spread evenly and mixed thoroughly to attain relative uniformity of material and moisture throughout.
- 4.2 Fill Moisture Conditioning:** Fill soils shall be watered, dried back, blended, and/or mixed, as necessary to attain a relatively uniform moisture content at or slightly over optimum. Maximum density and optimum soil moisture content tests shall be performed in accordance with the American Society of Testing and Materials (ASTM Test Method D1557).
- 4.3 Compaction of Fill:** After each layer has been moisture-conditioned, mixed, and evenly spread, it shall be uniformly compacted to not less than 90 percent of maximum dry density (ASTM Test Method D1557). Compaction equipment shall be adequately sized and be either specifically designed for soil compaction or of proven reliability to efficiently achieve the specified level of compaction with uniformity.
- 4.4 Compaction of Fill Slopes:** In addition to normal compaction procedures specified above, compaction of slopes shall be accomplished by backrolling of slopes with sheepsfoot rollers at increments of 3 to 4 feet in fill elevation, or by other methods producing satisfactory results acceptable to the Geotechnical Consultant. Upon completion of grading, relative compaction of the fill, out to the slope face, shall be at least 90 percent of maximum density per ASTM Test Method D1557.
- 4.5 Compaction Testing:** Field tests for moisture content and relative compaction of the fill soils shall be performed by the Geotechnical Consultant. Location and frequency of tests shall be at the Consultant's discretion based on field conditions encountered. Compaction test locations will not necessarily be selected on a random basis. Test locations shall be selected to verify adequacy of compaction levels in areas that are judged to be prone to inadequate compaction (such as close to slope faces and at the fill/bedrock benches).
- 4.6 Frequency of Compaction Testing:** Tests shall be taken at intervals not exceeding 2 feet in vertical rise and/or 1,000 cubic yards of compacted fill soils embankment. In addition, as a guideline, at least one test shall be taken on slope faces for each 5,000 square feet of slope face and/or each 10 feet of vertical height of slope. The Contractor shall assure that fill construction is such that the testing schedule can be accomplished by the Geotechnical Consultant. The Contractor shall stop or slow down the earthwork construction if these minimum standards are not met.
- 4.7 Compaction Test Locations:** The Geotechnical Consultant shall document the approximate elevation and horizontal coordinates of each test location. The Contractor shall coordinate with the project surveyor to assure that sufficient grade stakes are established so that the Geotechnical Consultant can determine the test locations with sufficient accuracy. At a minimum, two grade stakes within a horizontal distance of 100 feet and vertically less than 5 feet apart from potential test locations shall be provided.

5.0 Subdrain Installation

Subdrain systems shall be installed in accordance with the approved geotechnical report(s), the grading plan, and the Standard Details. The Geotechnical Consultant may recommend additional subdrains and/or changes in subdrain extent, location, grade, or material depending on conditions encountered during grading. All subdrains shall be surveyed by a land surveyor/civil engineer for line and grade after installation and prior to burial. Sufficient time should be allowed by the Contractor for these surveys.

6.0 Excavation

Excavations, as well as over-excavation for remedial purposes, shall be evaluated by the Geotechnical Consultant during grading. Remedial removal depths shown on geotechnical plans are estimates only. The actual extent of removal shall be determined by the Geotechnical Consultant based on the field evaluation of exposed conditions during grading. Where fill-over-cut slopes are to be graded, the cut portion of the slope shall be made, evaluated, and accepted by the Geotechnical Consultant prior to placement of materials for construction of the fill portion of the slope, unless otherwise recommended by the Geotechnical Consultant.

7.0 Trench Backfills

- 7.1** The Contractor shall follow all OSHA and Cal/OSHA requirements for safety of trench excavations.
- 7.2** All bedding and backfill of utility trenches shall be done in accordance with the applicable provisions of Standard Specifications of Public Works Construction. Bedding material shall have a Sand Equivalent greater than 30 ($SE > 30$). The bedding shall be placed to 1 foot over the top of the conduit and densified by jetting. Backfill shall be placed and densified to a minimum of 90 percent of maximum from 1 foot above the top of the conduit to the surface.
- 7.3** The jetting of the bedding around the conduits shall be observed by the Geotechnical Consultant.
- 7.4** The Geotechnical Consultant shall test the trench backfill for relative compaction. At least one test should be made for every 300 feet of trench and 2 feet of fill.
- 7.5** Lift thickness of trench backfill shall not exceed those allowed in the Standard Specifications of Public Works Construction unless the Contractor can demonstrate to the Geotechnical Consultant that the fill lift can be compacted to the minimum relative compaction by his alternative equipment and method.

Fill Slope

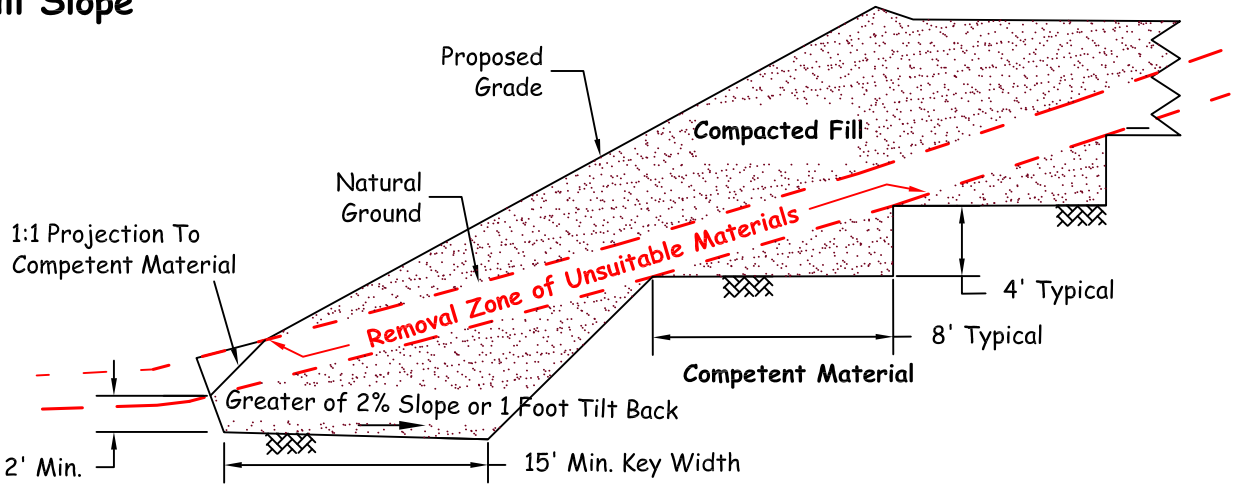

Fill-Over-Cut Slope

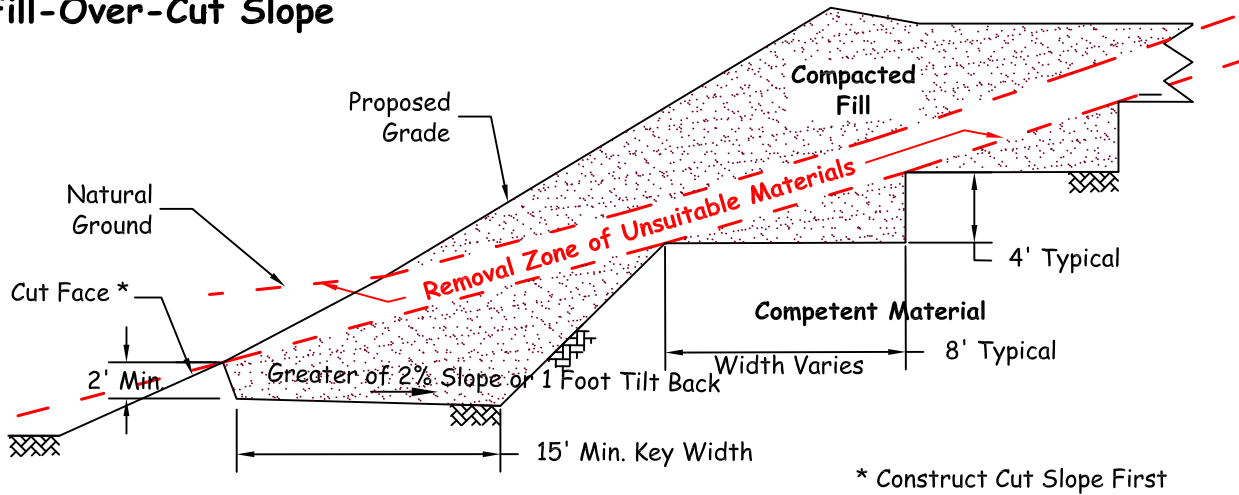

Cut-Over-Fill Slope

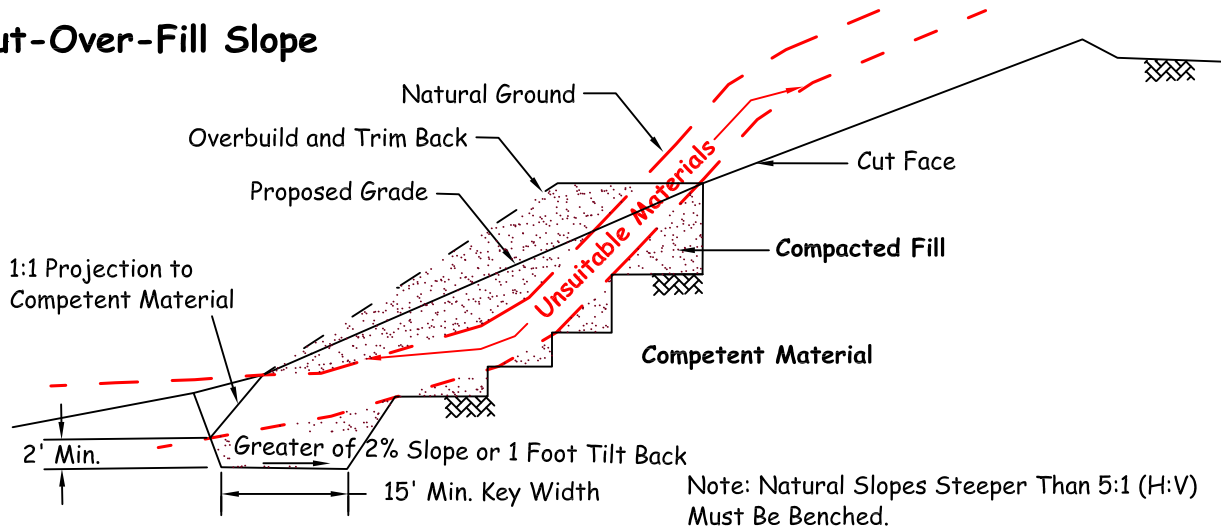

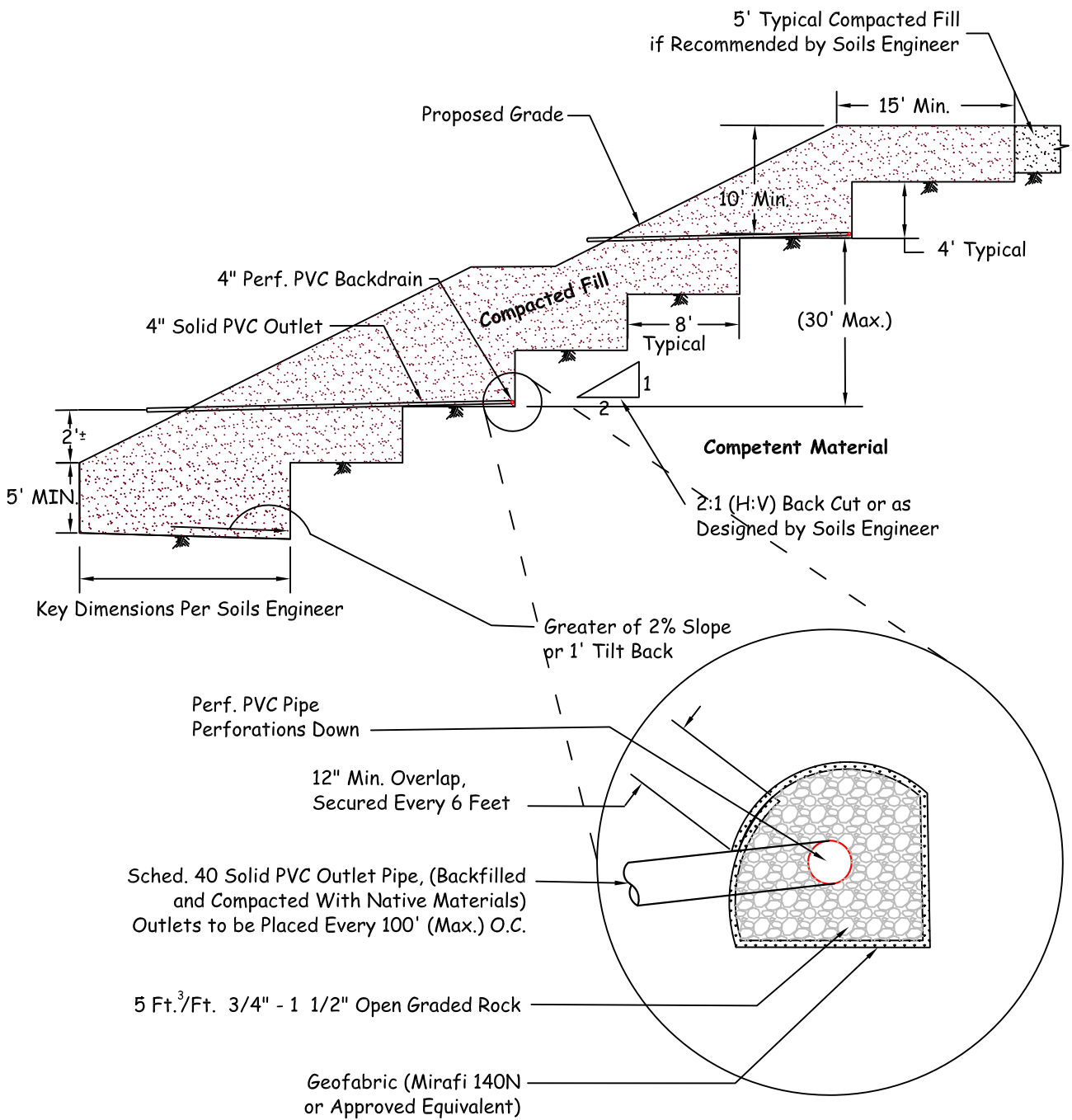

TYPICAL BUTTRESS DETAIL

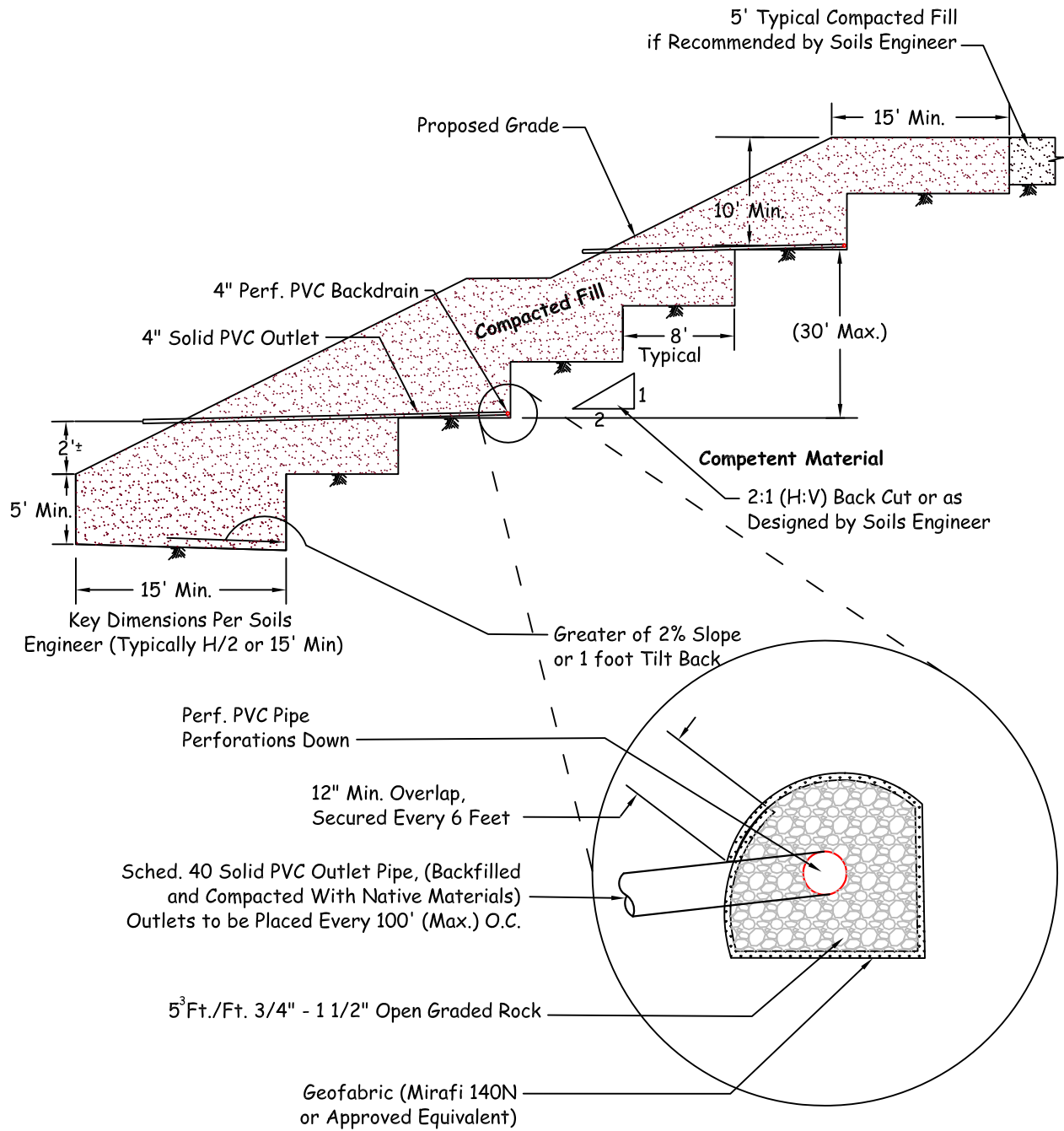

TYPICAL STABILIZATION FILL DETAIL

Cut Lot (Exposing Unsuitable Soils at Design Grade)

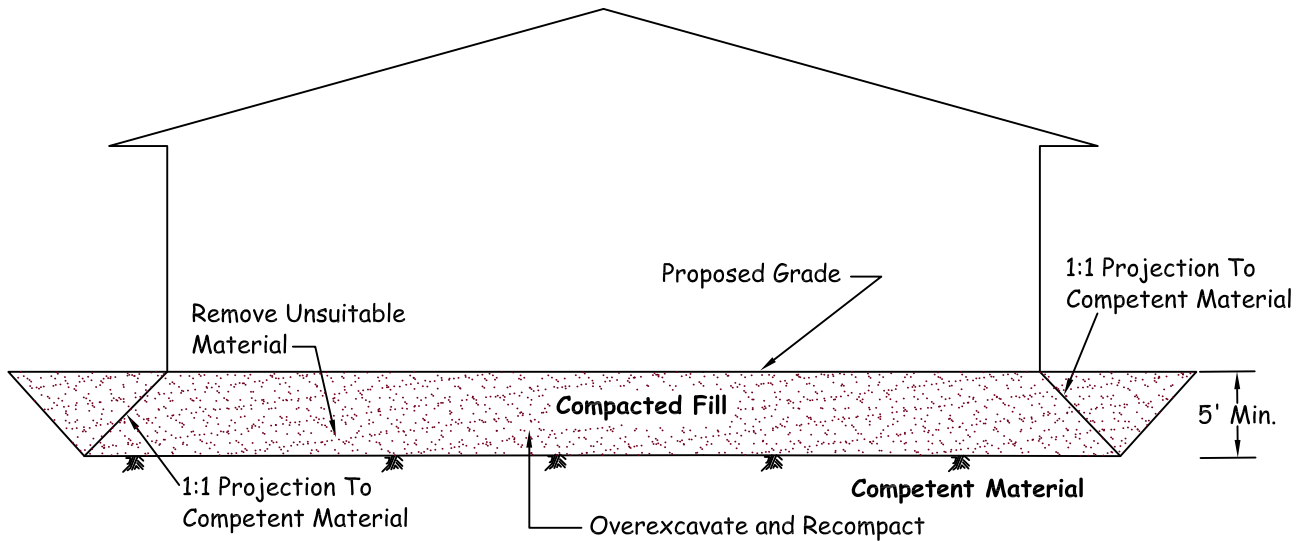

Note 1: Removal Bottom Should be Graded With Minimum 2% Fall Towards Street or Other Suitable Area (as Determined by Soils Engineer) to Avoid Ponding Below Building

Note 2: Where Design Cut Lots are Excavated Entirely Into Competent Material, Overexcavation May Still be Required for Hard-Rock Conditions or for Materials With Variable Expansion Characteristics.

Cut/Fill Transition Lot

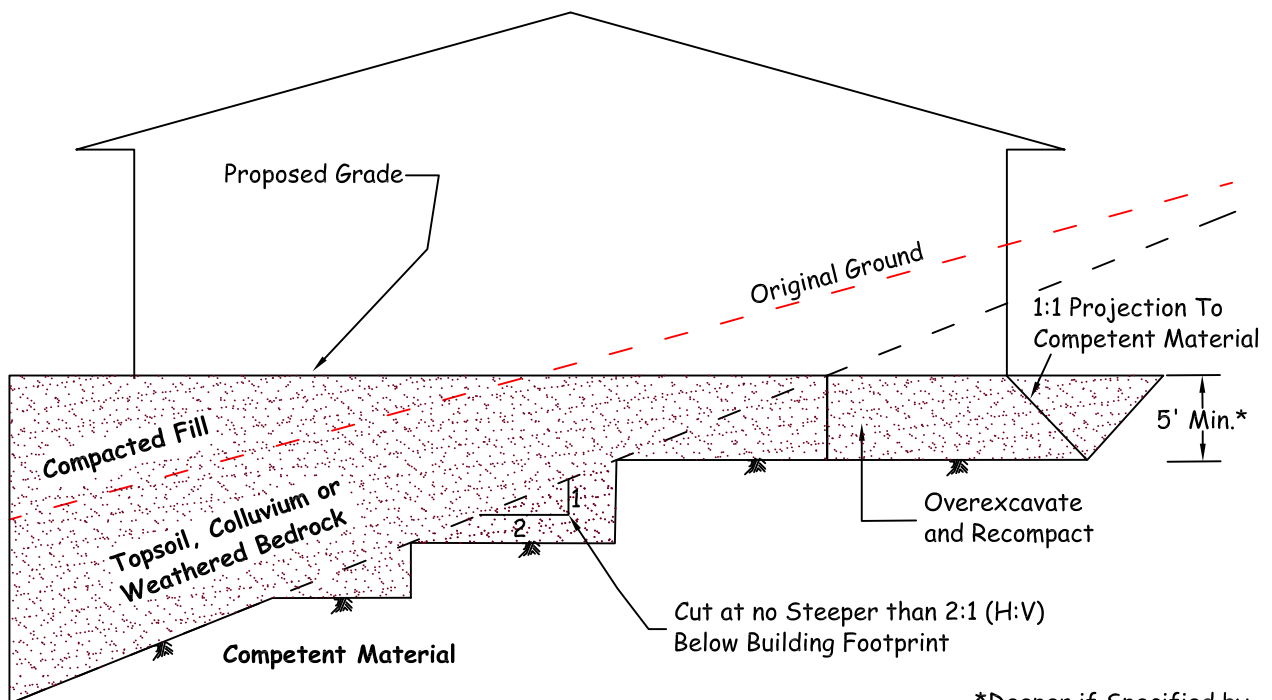

*Deeper if Specified by Soils Engineer



CUT AND TRANSITION LOT OVEREXCAVATION DETAIL

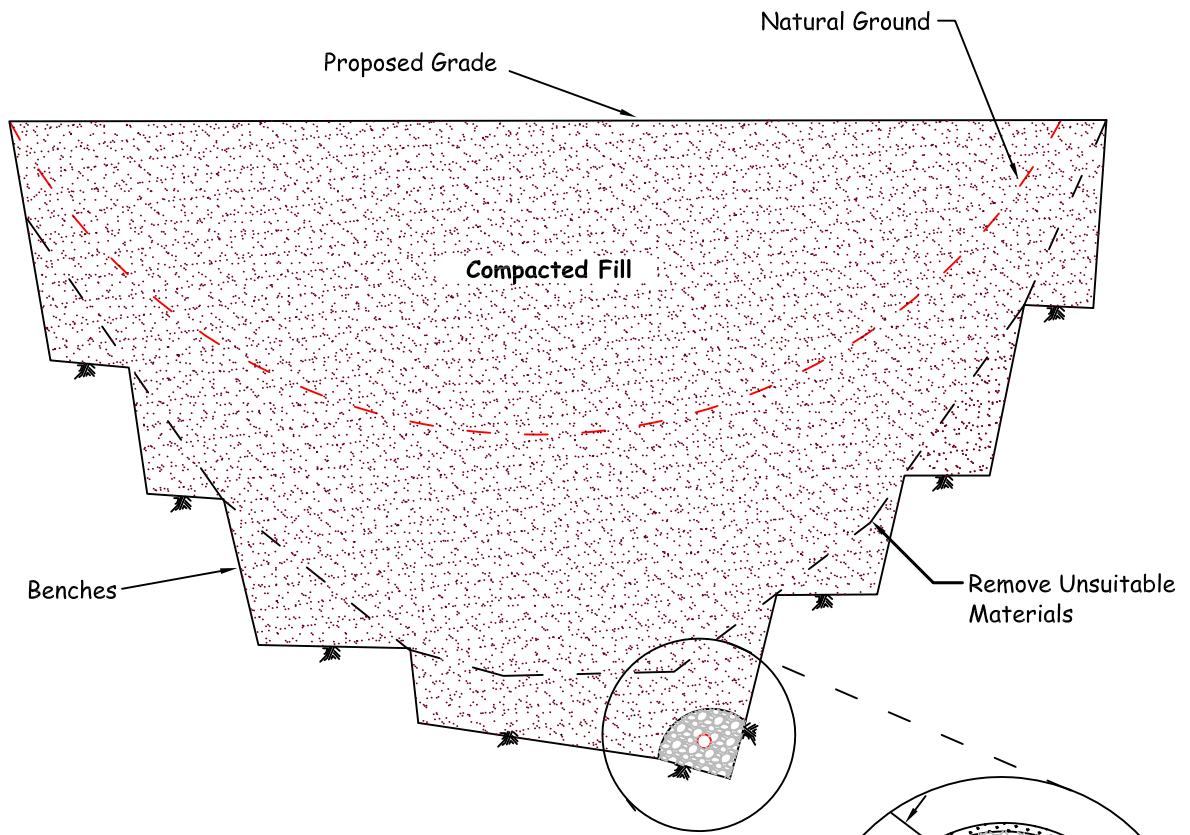

Notes:

- 1) Continuous Runs in Excess of 500' Shall Use 8" Diameter Pipe.
- 2) Final 20' of Pipe at Outlet Shall be Solid and Backfilled with Fine-grained Material.

12" Min. Overlap,
Secured Every 6 Feet

6" Collector Pipe
(Sched. 40, Perf. PVC)

9 Ft.³/Ft.
3/4" - 1 1/2" Crushed Rock

Geofabric (Mirafi 140N
or Approved Equivalent)

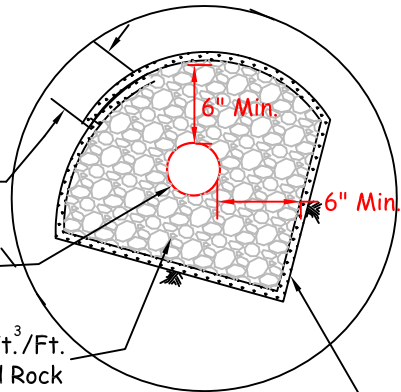

Proposed Outlet Detail

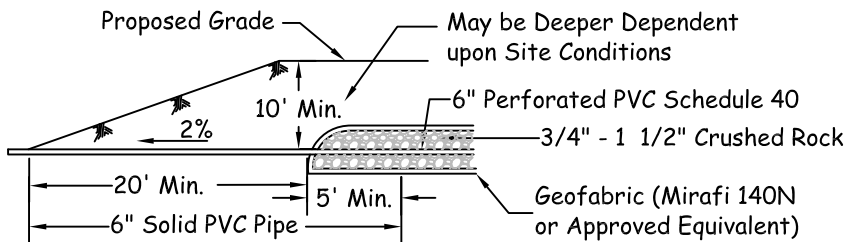

CANYON SUBDRAINS

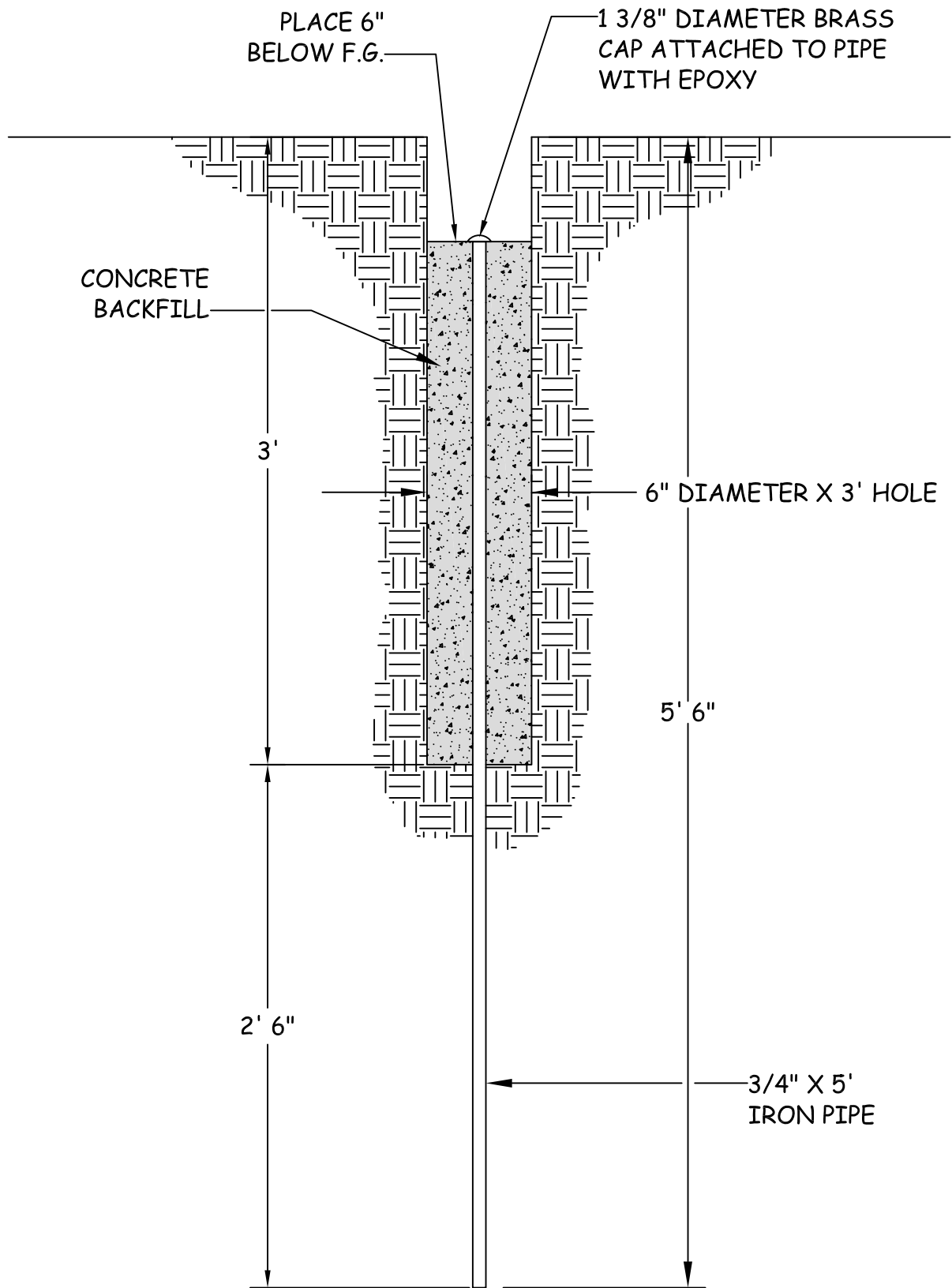

**TYPICAL SURFACE
SETTLEMENT
MONUMENT**

TOP VIEW

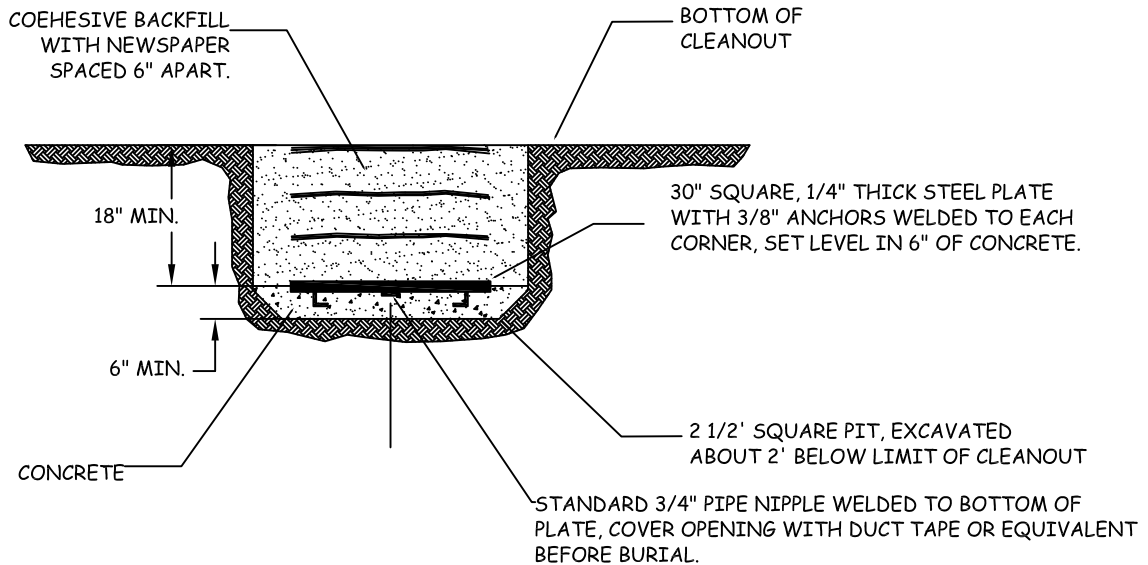
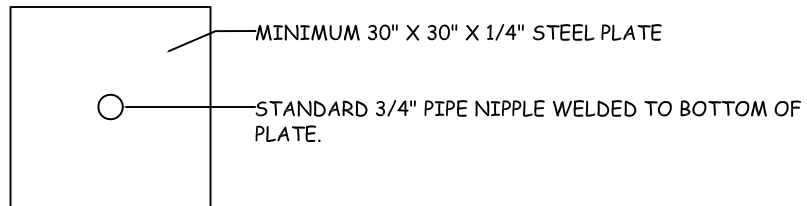

1. SURVEY FOR HORIZONTAL AND VERTICAL LOCATION TO NEAREST .01 INCH PRIOR TO BACKFILL USING KNOW LOCATIONS THAT WILL REMAIN INTACT DURING THE DURATION OF THE MONITORING PROGRAM. KNOW POINTS EXPLICITLY NOT ALLOWED ARE THOSE LOCATED ON FILL OR THAT WILL BE DESTROYED DURING GRADING.
2. IN THE EVENT OF DAMAGE TO SETTLEMENT PLATE DURING GRADING, CONTRACTOR SHALL IMMEDIATELY NOTIFY THE GEOTECHNICAL ENGINEER AND SHALL BE RESPONSIBLE FOR RESTORING THE SETTLEMENT PLATES TO WORKING ORDER.
3. DRILL TO RECOVER AND ATTACH RISER PIPE.



TYPICAL SETTLEMENT PLATE AND RISER

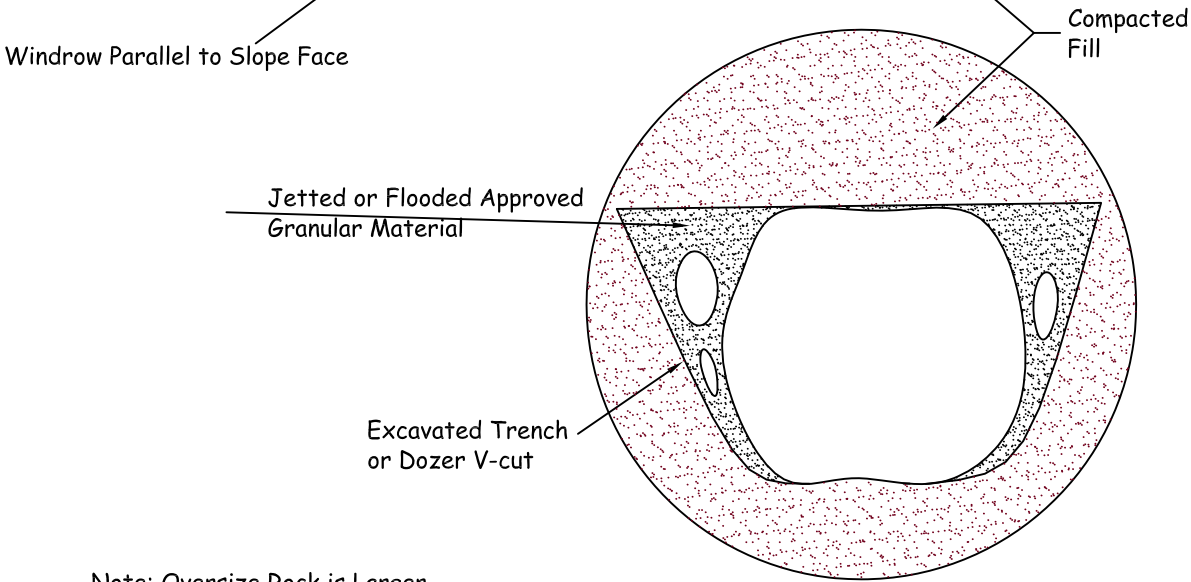
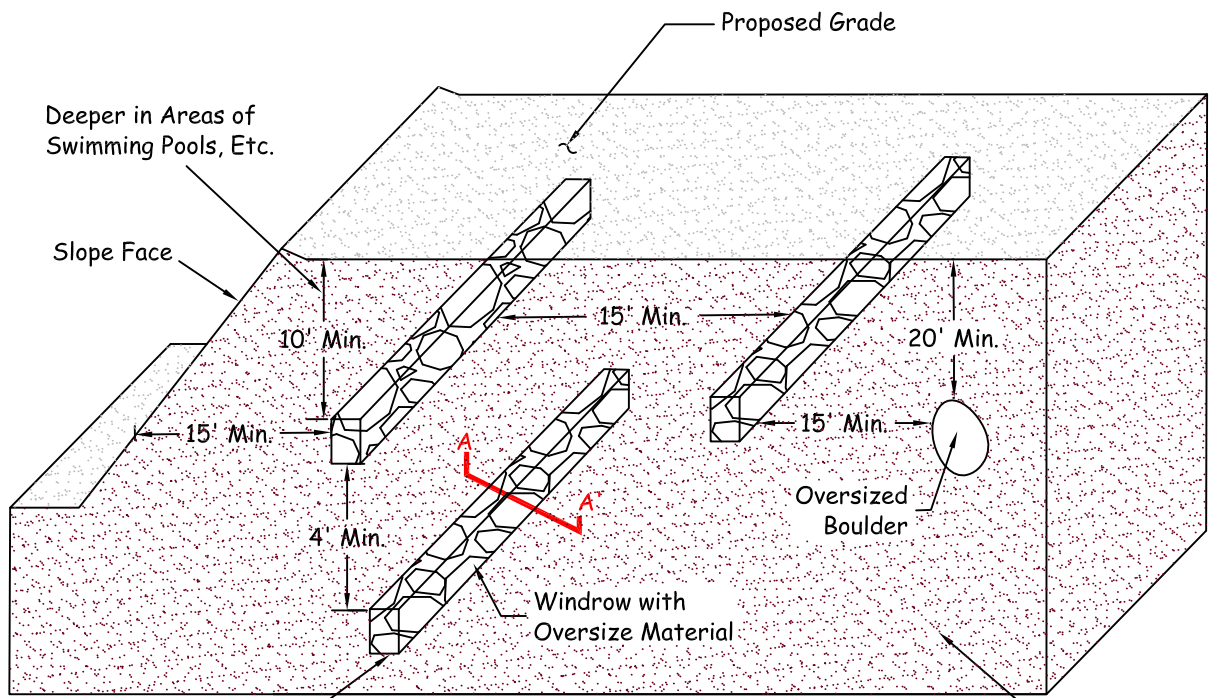

Note: Oversize Rock is Larger than 8" in Maximum Dimension.

Section A-A'



OVERSIZE ROCK DISPOSAL DETAIL

***Geotechnical Evaluation and Slope Stabilization
Design for Environmental Impact Report
Purposes, for Proposed New Structures at the
South Shores Church, City of Dana Point,
California***

Volume III

Prepared For:

Mr. GG Kohlhagan

**South Shores Church
32712 Crown Valley Parkway
Dana Point, CA 92629**

Dated: May 22, 2013

Project No. 10132-01

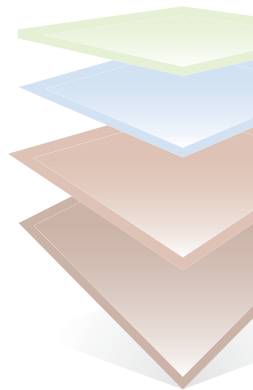

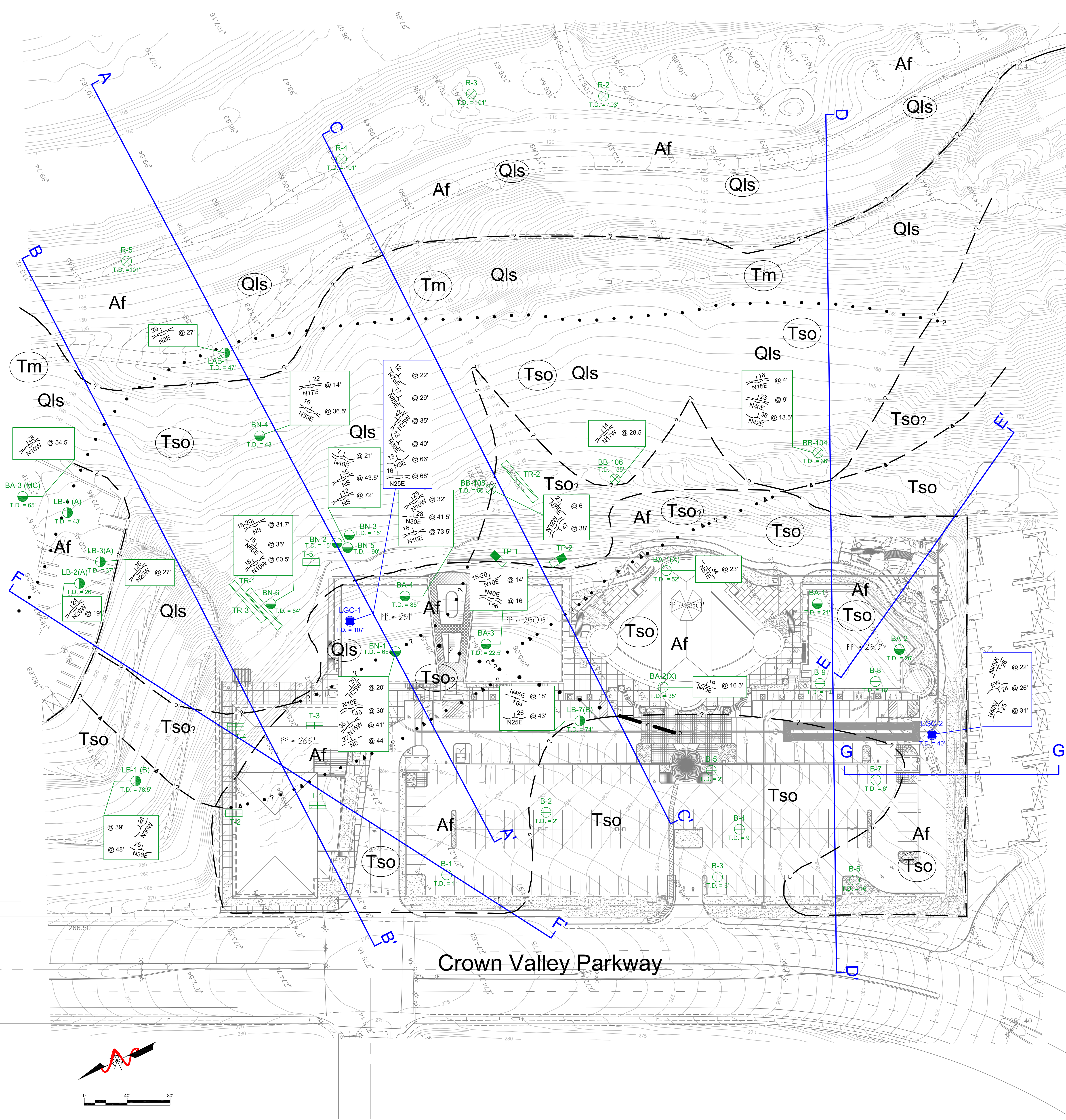

LEGEND

Approximate Locations of Borings and Trenches with Total Depth in Feet (Borings Only):

- LGC-1 Recent Borings by LGC Geotechnical, Inc.
- B-9 Hollow Stem Boring by Nicoll (2006)
- BA-2(X) Bucket Auger Boring by Nicoll (1993)
- BA-4 Bucket Auger Boring by Nicoll (2006)
- BN-6 Bucket Auger Boring by Nicoll (2007)
- T-5 Test Pit by Nicoll (2006b)
- ▭ TR-3 Trench by Nicoll (2007)
- ▭ TP-2 Test Pit by Nicoll (2006a)
- BA-3 (MC) Bucket Auger Boring for Monarch Coast Apartments by Nicoll (2007)
- LB-3(A) Bucket Auger Boring by Moran (1977)
- LB-7(B) Bucket Auger Boring by Leighton & Associates (1985) from Nicoll (1993)
- LB-1 Bucket Auger Boring by Leighton & Associates (1986)
- BB-108 Bucket Auger Boring by Agra (2000)
- R-5 Rotary Wash Boring by Agra (2000)

Earth Units (Circled Where Buried):

- Af** Artificial Fill
- Qls** Quaternary Landslide
- Tm** Tertiary Monterey Formation
- Tso** Tertiary San Onofre Formation

Map and Cross Section Symbols:

- · - · Approximate Location of Geologic Contact, Dotted Where Buried, Queried Where Uncertain
- · - · Approximate Location of Fault, Dotted Where Buried, Queried Where Uncertain
- · - · Approximate Location of Geologic Silty Clay Bed, Dotted Where Buried, Queried Where Uncertain
- A-A' Approximate Cross Section Alignment
- N40W / 28' @ 22' Bedding Attitude with Depth in Feet (Dashed Where Buried)
- 13 / N5E @ 66' General Bedding Attitude with Depth in Feet (Dashed Where Buried)
- 135 / N15W @ 41' Rupture Surface Attitude with Depth in Feet (Dashed Where Buried)
- N46E / 164' @ 18' Fault Attitude with Depth in Feet (Dashed Where Buried)



LGC GEOTECHNICAL, INC.
 120 Calle Iglesia
 San Clemente, CA 92672
 TEL (949) 369-6141 FAX (949) 369-6142







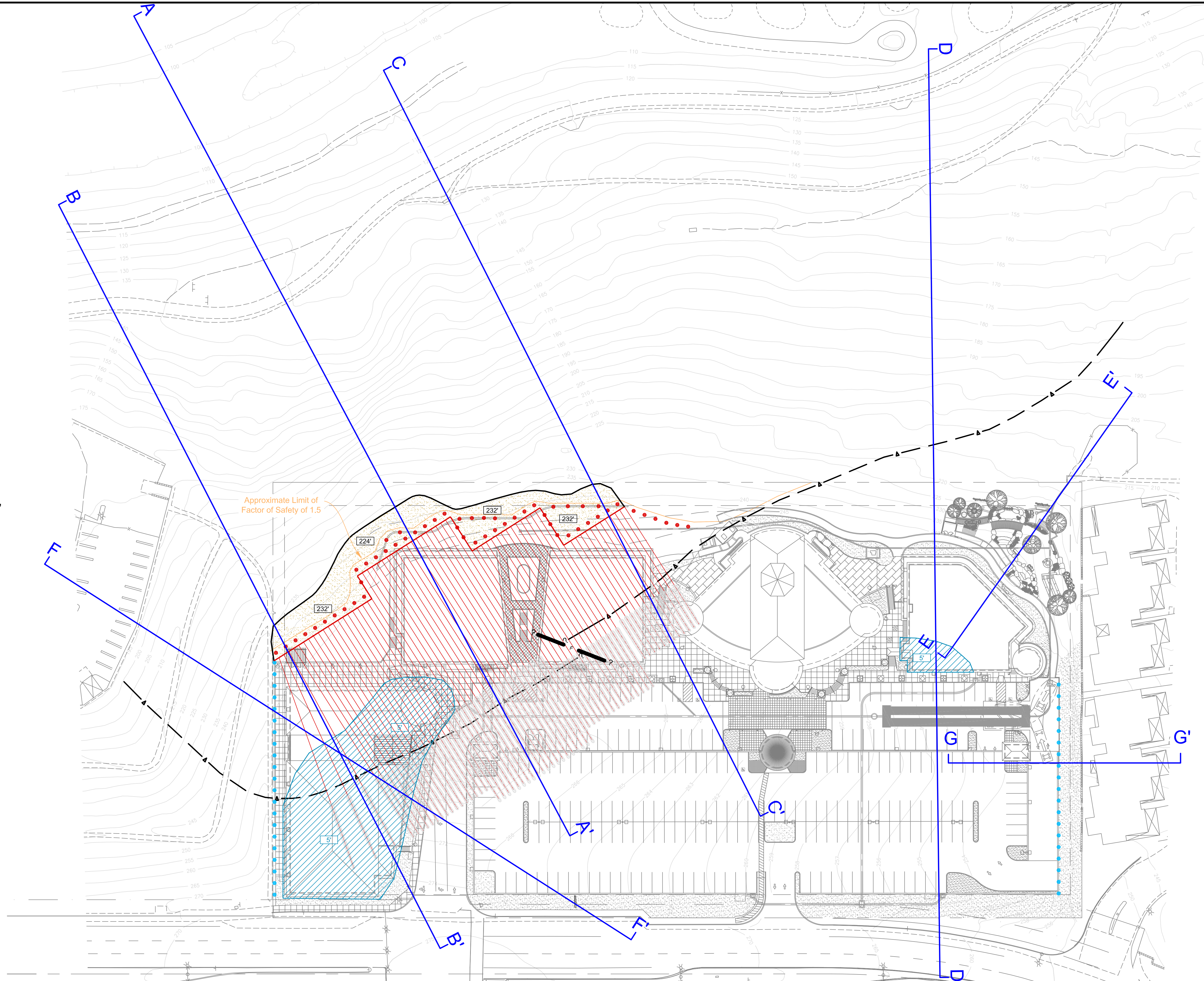

**South Shores Church - Master Plan
 Geotechnical Map**

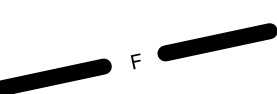
CLIENT:
 South Shores Church
 32712 Crown Valley Parkway
 Dana Point, California

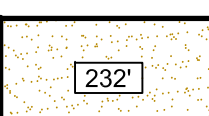
PROJECT NAME	South Shores Church
PROJECT NO.	10132-01
ENG. / GEOL.	TJL / KTM
SCALE	1" = 40'
DATE	May 2013

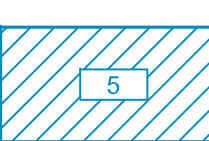

LEGEND

-  Approximate Location of Silty Clay Bed (Engineered Fill Overlies Majority of Feature, Not Depicted)
-  Approximate Location of Fault
-  Cross Section Alignment
-  Approximate Location of Tieback Access Excavation, with Elevation in Feet
-  Approximate Limits of Tieback Access Excavation
-  Approximate Location of Tieback Column Relative to Reaction Wall
Number of Tiebacks in Columns Vary
Tiebacks to be Spaced 5 Feet on Center
-  Approximate Location of Caissons to be Installed in Front of Reaction Wall (to be Connected by Grade Beams)
-  Approximate Location of Over-Excavation with Depth in Feet
-  Approximate Location of Caissons for Deepened Footing (to be Connected by Grade Beams)



LGC GEOTECHNICAL, INC.
 120 Calle Iglesia, Ste. A
 San Clemente, CA 92672
 TEL (949) 369-6141 FAX (949) 369-6142

**Preliminary Remedial Measures Map - Master Plan
 South Shores Church**

CLIENT:
 South Shores Church
 32712 Crown Valley Parkway
 Dana Point, California

PROJECT NAME	South Shores Church
PROJECT NO.	10132-01
ENG. / GEOL.	TJL / KTM
SCALE	1" = 40'
DATE	May 2013

**SHEET
 2 of 10**

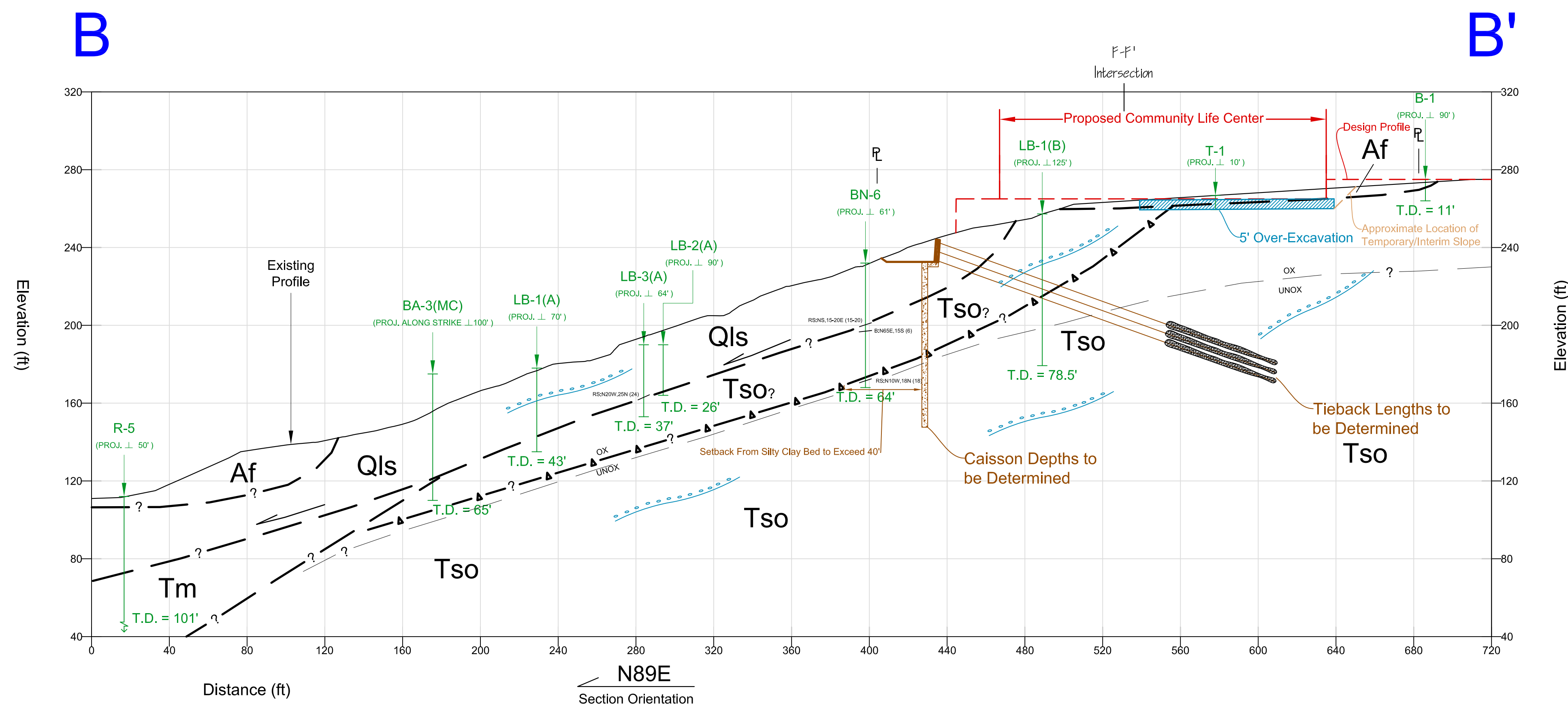
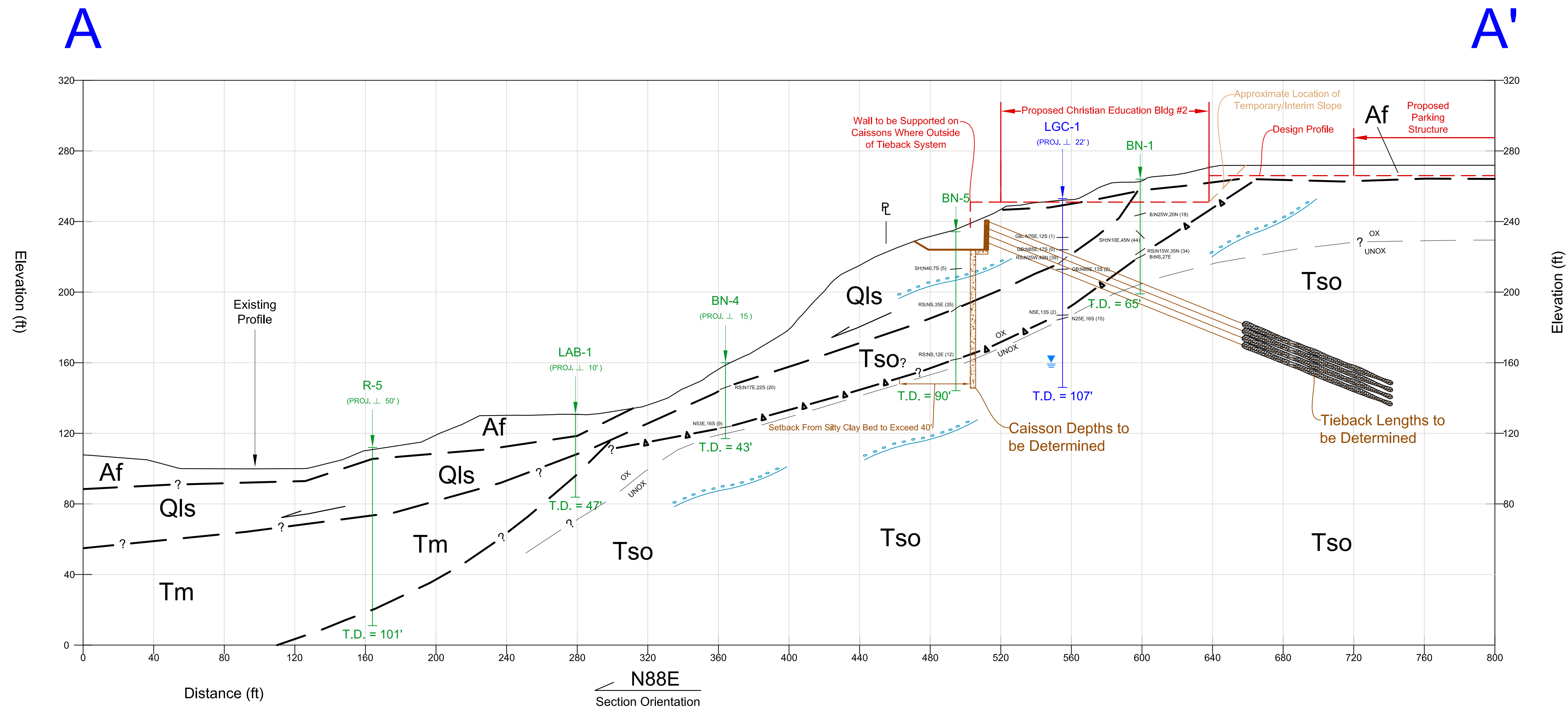

LGC GEOTECHNICAL, INC.
 120 Calle Iglesia, Ste. A
 San Clemente, CA 92672
 TEL (949) 369-6141 FAX (949) 369-6142

**South Shores Church - Master Plan
 Geotechnical Cross Sections A-A' and B-B'**

CLIENT:
 South Shores Church
 32712 Crown Valley Parkway
 Dana Point, California

PROJECT NAME	South Shores Church
PROJECT NO.	10132-01
ENG. / GEOL.	TJL / KTM
SCALE	1" = 40'
DATE	May 2013

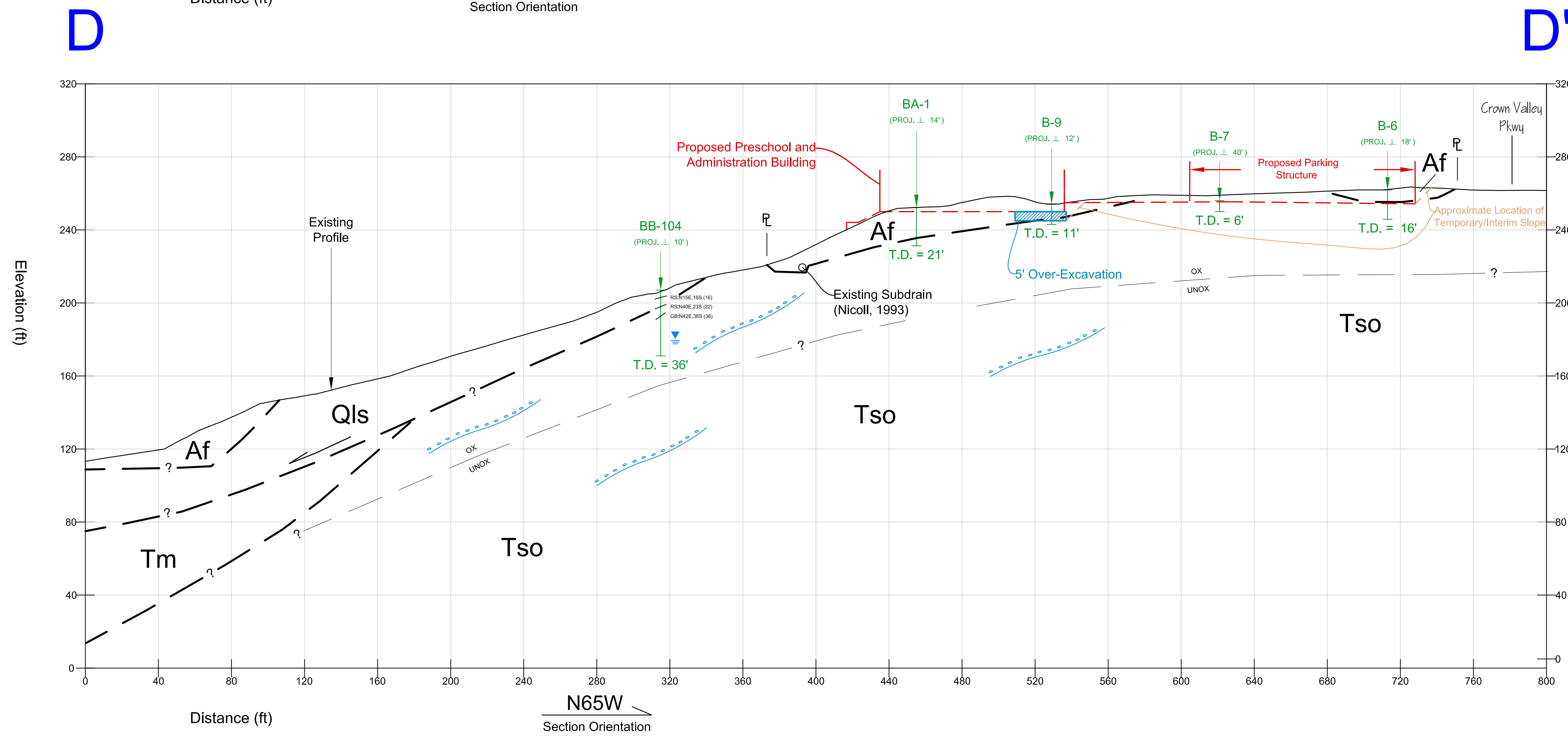
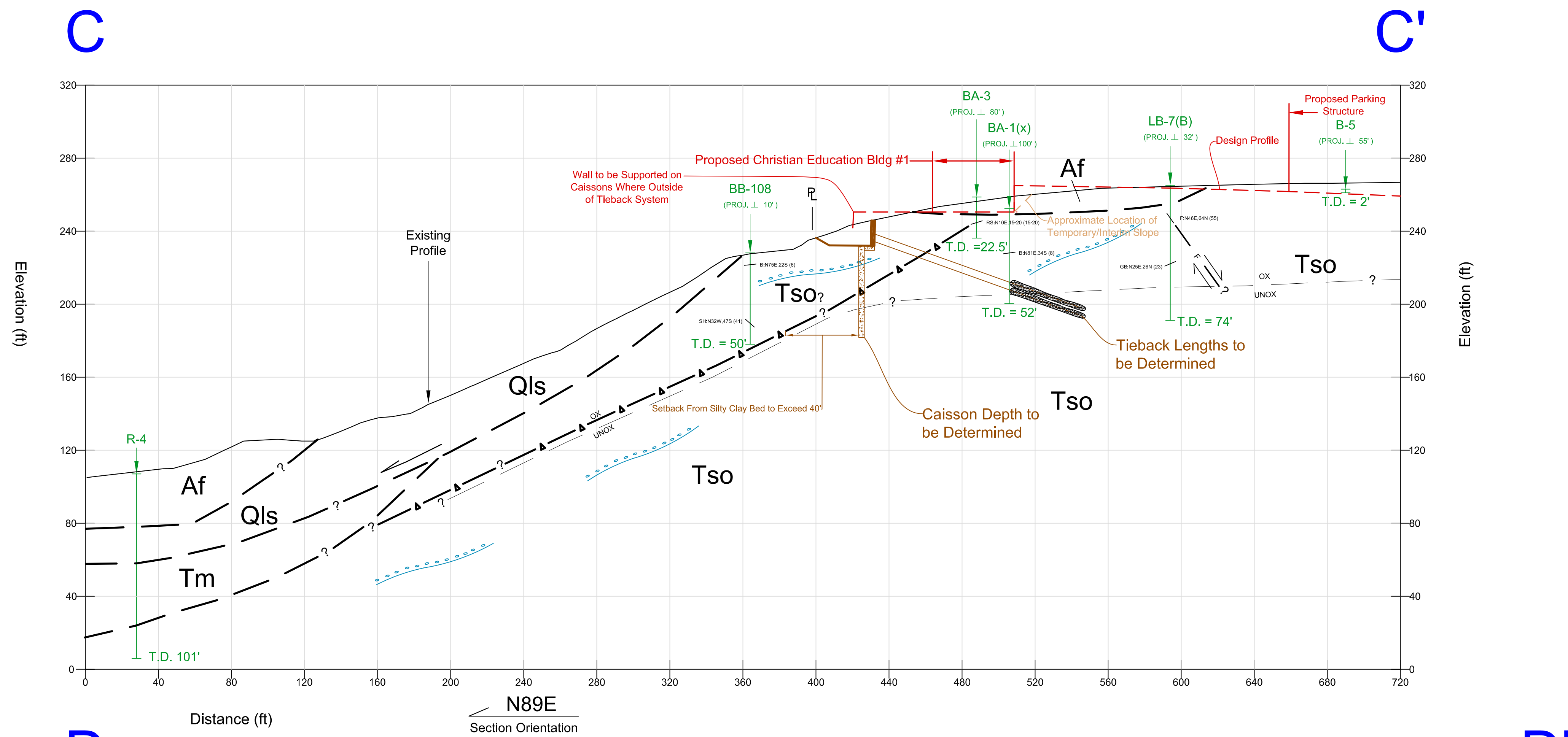

LGC GEOTECHNICAL, INC.
 120 Calle Iglesia, Ste. A
 San Clemente, CA 92672
 TEL (949) 369-6141 FAX (949) 369-6142

South Shores Church Geotechnical - Master Plan
Cross Sections C-C' and D-D'

CLIENT:
 South Shores Church
 32712 Crown Valley Parkway
 Dana Point, California

PROJECT NAME	South Shores Church
PROJECT NO.	10132-01
ENG. / GEOL.	TJL / KTM
SCALE	1" = 40'
DATE	May 2013

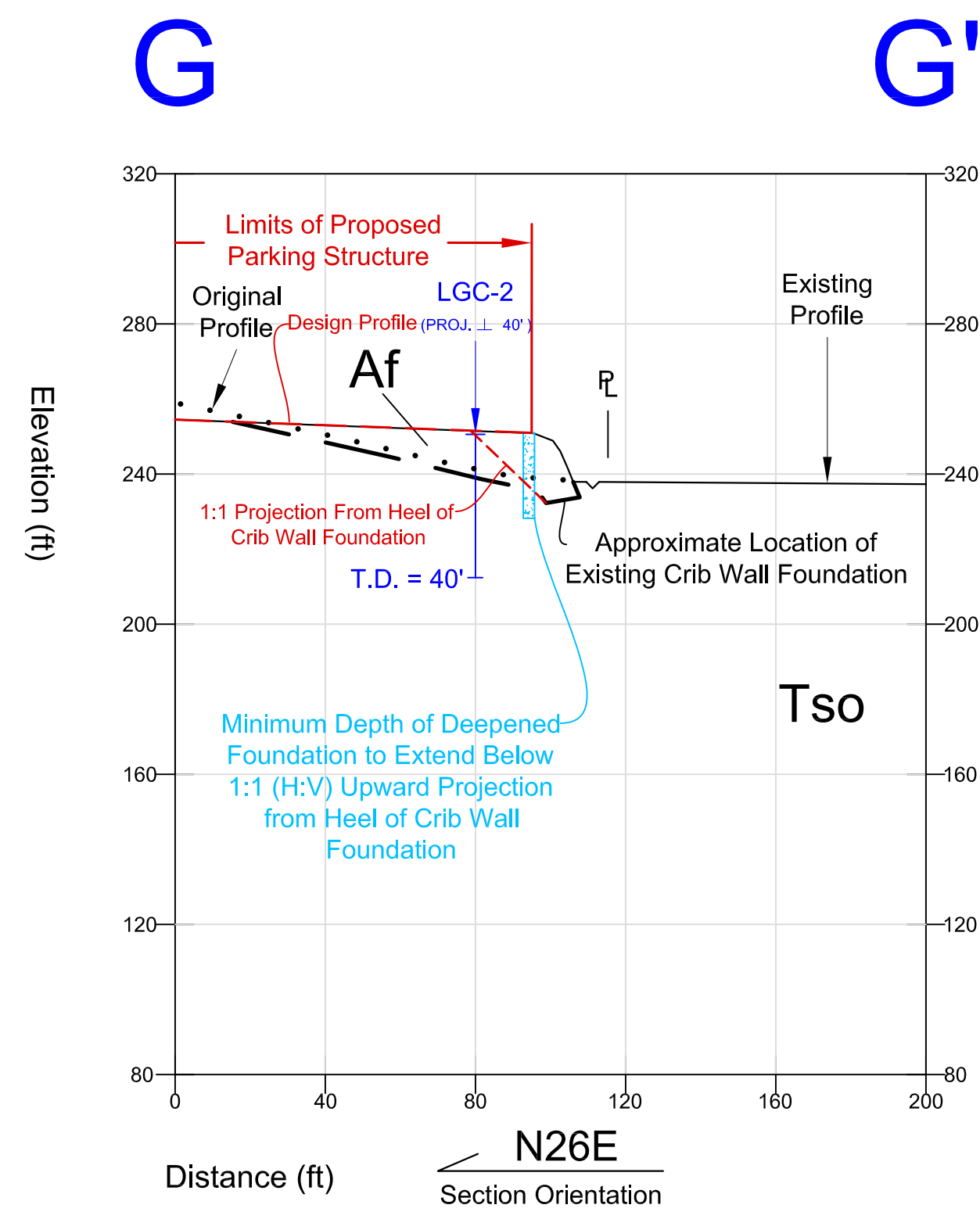
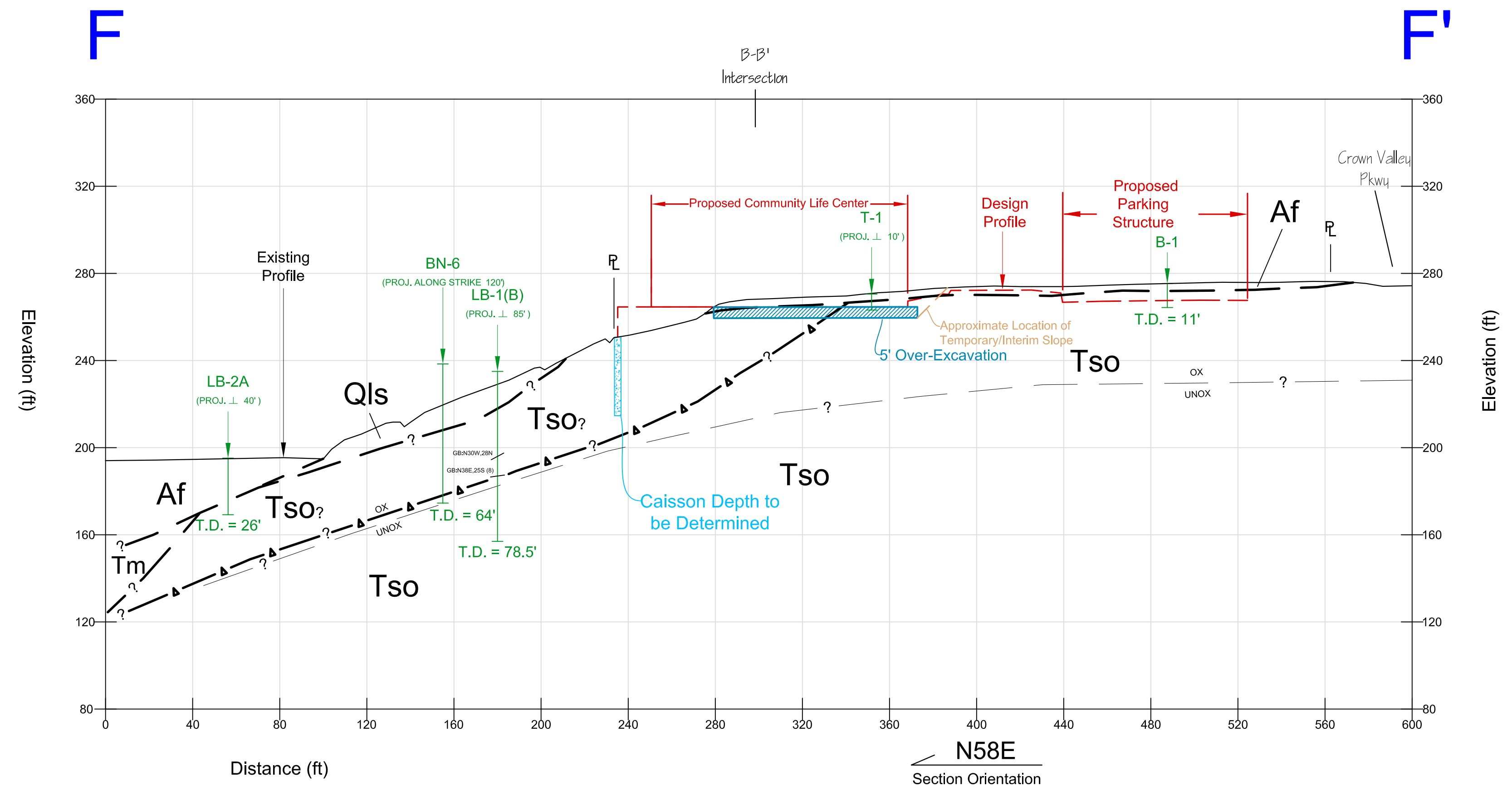
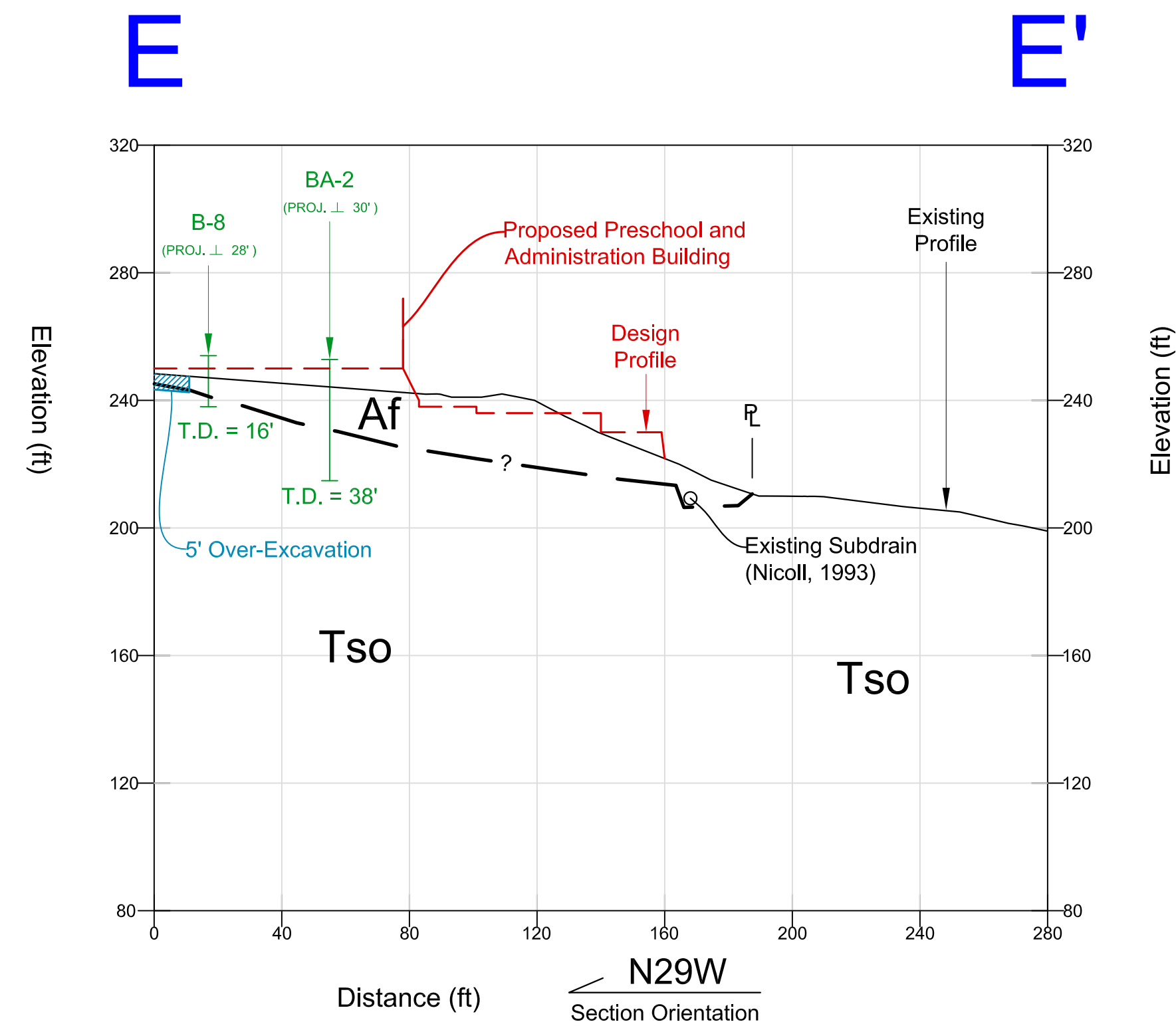

LGC GEOTECHNICAL, INC.
 120 Calle Iglesia, Ste. A
 San Clemente, CA 92672
 TEL (949) 369-6141 FAX (949) 369-6142

South Shores Church Geotechnical - Master Plan
Cross Sections E-E' and F-F'

CLIENT:
 South Shores Church
 32712 Crown Valley Parkway
 Dana Point, California

PROJECT NAME	South Shores Church
PROJECT NO.	10132-01
ENG. / GEOL.	TJL / KTM
SCALE	1" = 40'
DATE	May 2013

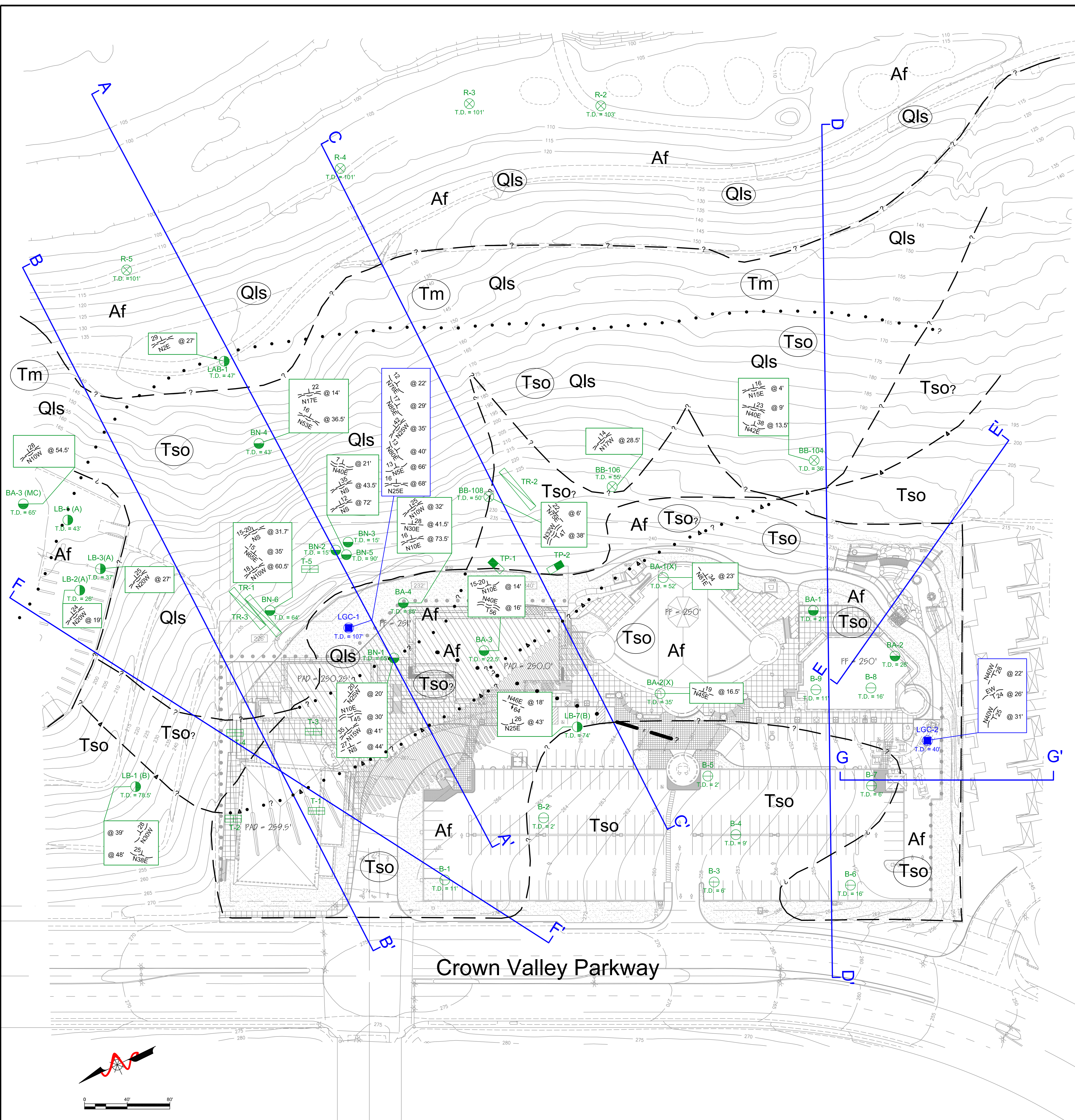

LEGEND

Approximate Locations of Borings and Trenches with Total Depth in Feet (Borings Only):

- LGC-1 Recent Borings by LGC Geotechnical, Inc.
- B-9 Hollow Stem Boring by Nicoll (2006)
- BA-2(X) Bucket Auger Boring by Nicoll (1993)
- BA-4 Bucket Auger Boring by Nicoll (2006)
- BN-6 Bucket Auger Boring by Nicoll (2007)
- T-5 Test Pit by Nicoll (2006b)
- TR-3 Trench by Nicoll (2007)
- TP-2 Test Pit by Nicoll (2006a)
- BA-3 (MC) Bucket Auger Boring for Monarch Coast Apartments by Nicoll (2007)
- LB-3(A) Bucket Auger Boring by Moran (1977)
- LB-7(B) Bucket Auger Boring by Leighton & Associates (1985) from Nicoll (1993)
- LAB-1 Bucket Auger Boring by Leighton & Associates (1986)
- BB-108 Bucket Auger Boring by Agra (2000)
- R-5 Rotary Wash Boring by Agra (2000)

Earth Units (Circled Where Buried):

- Af** Artificial Fill
- Qls** Quaternary Landslide
- Tm** Tertiary Monterey Formation
- Tso** Tertiary San Onofre Formation

Map and Cross Section Symbols:

- Approximate Location of Geologic Contact, Dotted Where Buried, Queried Where Uncertain
- Approximate Location of Fault, Dotted Where Buried, Queried Where Uncertain
- Approximate Location of Geologic Silty Clay Bed, Dotted Where Buried, Queried Where Uncertain
- Approximate Cross Section Alignment
- Bedding Attitude with Depth in Feet (Dashed Where Buried)
- General Bedding Attitude with Depth in Feet (Dashed Where Buried)
- Rupture Surface Attitude with Depth in Feet (Dashed Where Buried)
- Fault Attitude with Depth in Feet (Dashed Where Buried)



LGC GEOTECHNICAL, INC.
 120 Calle Iglesia
 San Clemente, CA 92672
 TEL (949) 369-6141 FAX (949) 369-6142





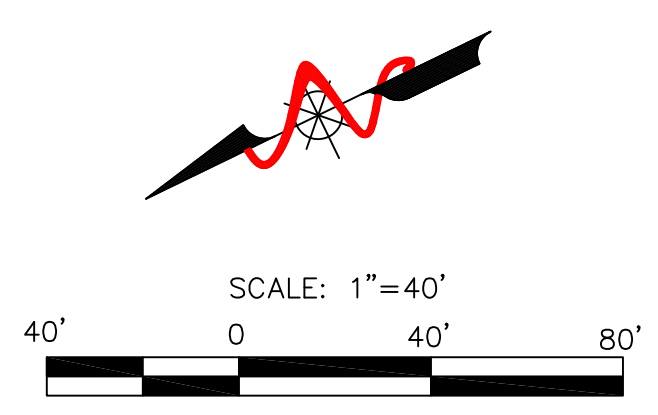

**South Shores Church - Alternative Design
 Geotechnical Map**

CLIENT:
 South Shores Church
 32712 Crown Valley Parkway
 Dana Point, California

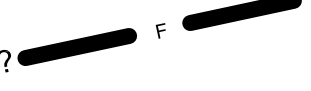
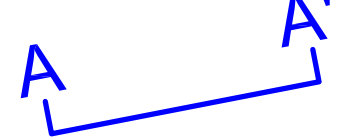
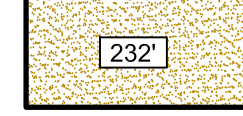
PROJECT NAME	South Shores Church	SHEET 6 of 10
PROJECT NO.	10132-01	
ENG. / GEOL.	TJL / KTM	
SCALE	1" = 40'	
DATE	May 2013	

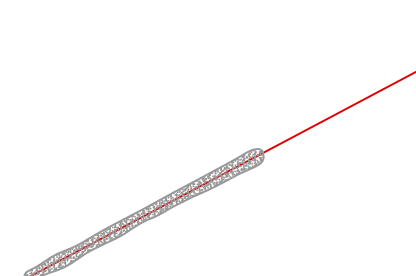

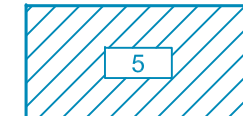
LEGEND

-  Approximate Location of Silty Clay Bed
(Engineered Fill Overlies Majority of Feature,
Not Depicted)
-  Approximate Location of Fault
-  Cross Section Alignment
-  Approximate Location of Tieback Access
Excavation, with Elevation in Feet
-  Approximate Limits of Tieback Access
Excavation
-  Approximate Location of Tieback
Column Relative to Reaction Wall
Number of Tiebacks in Columns Vary
Tiebacks to be Spaced 5 Feet on Center
-  Approximate Location of Caissons to be
Installed in Front of Reaction Wall
(To Be Connected by Grade Beams)
-  Approximate Location of Over-Excavation
with Depth in Feet
-  Approximate Location of Caissons for
Deepened Footing
(To Be Connected by Grade Beams)

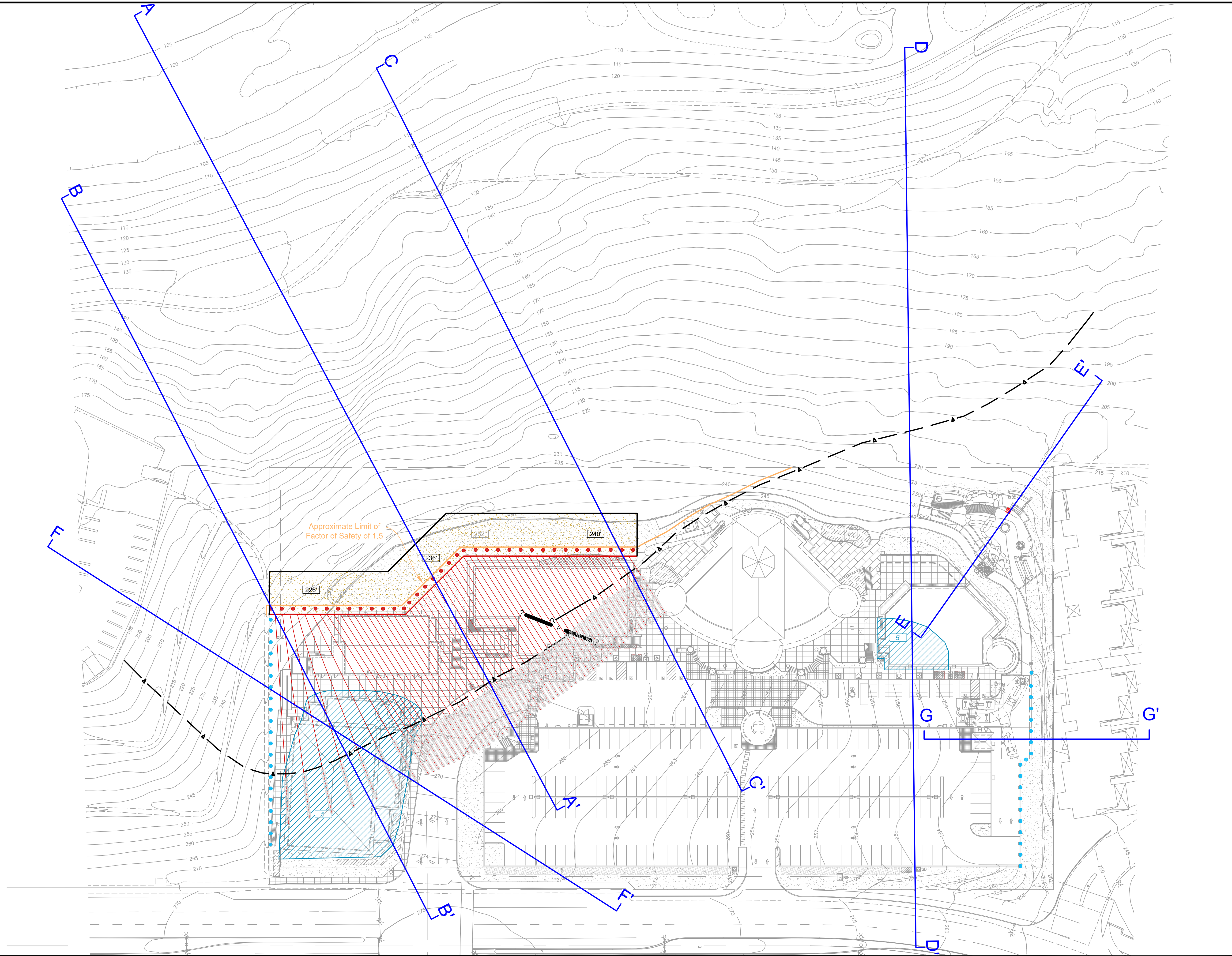

LGC GEOTECHNICAL, INC.
 120 Calle Iglesia, Ste. A
 San Clemente, CA 92672
 TEL (949) 369-6141 FAX (949) 369-6142

**South Shores Church - Alternative Design
 Preliminary Remedial Measures Map**

CLIENT:
 South Shores Church
 32712 Crown Valley Parkway
 Dana Point, California

PROJECT NAME	South Shores Church
PROJECT NO.	10132-01
ENG. / GEOL.	TJL / KTM
SCALE	1" = 40'
DATE	May 2013

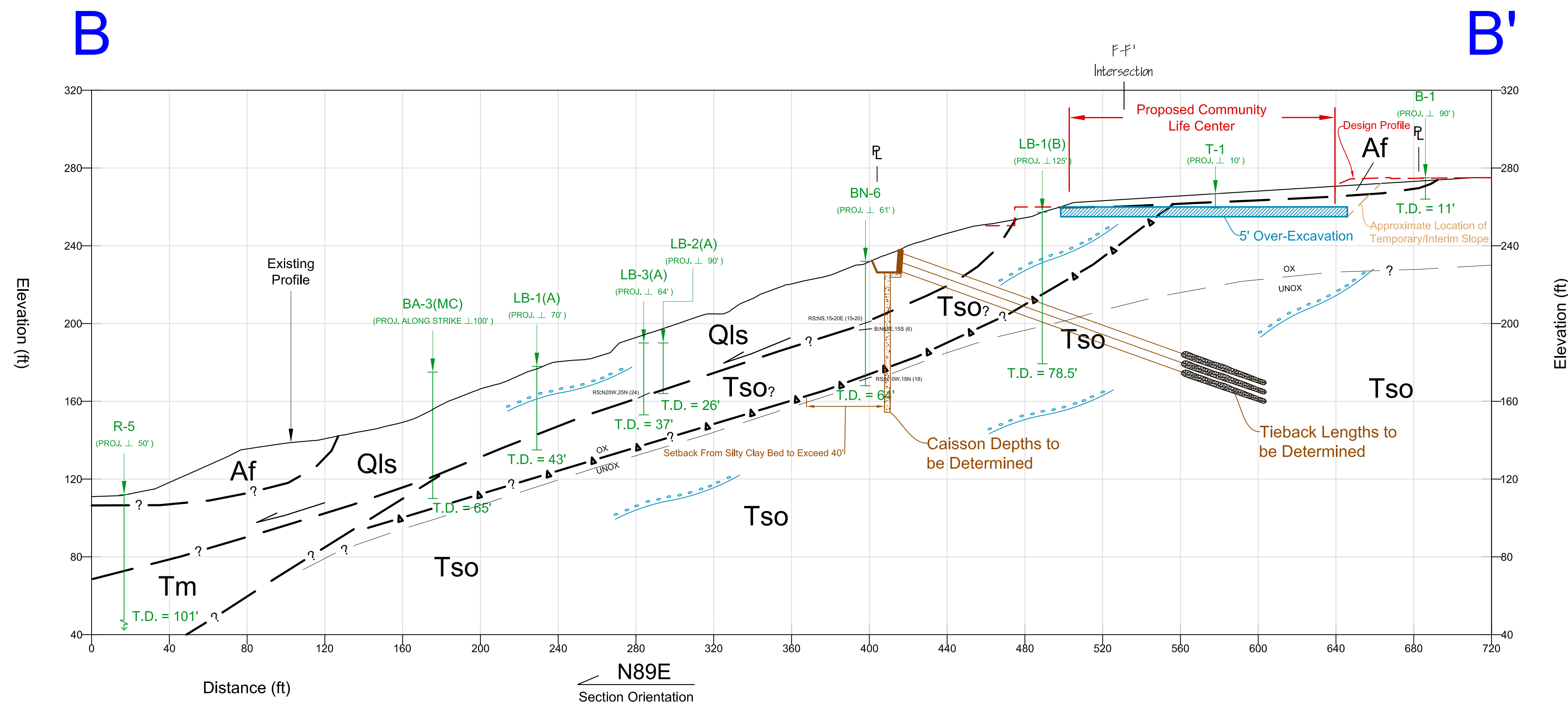
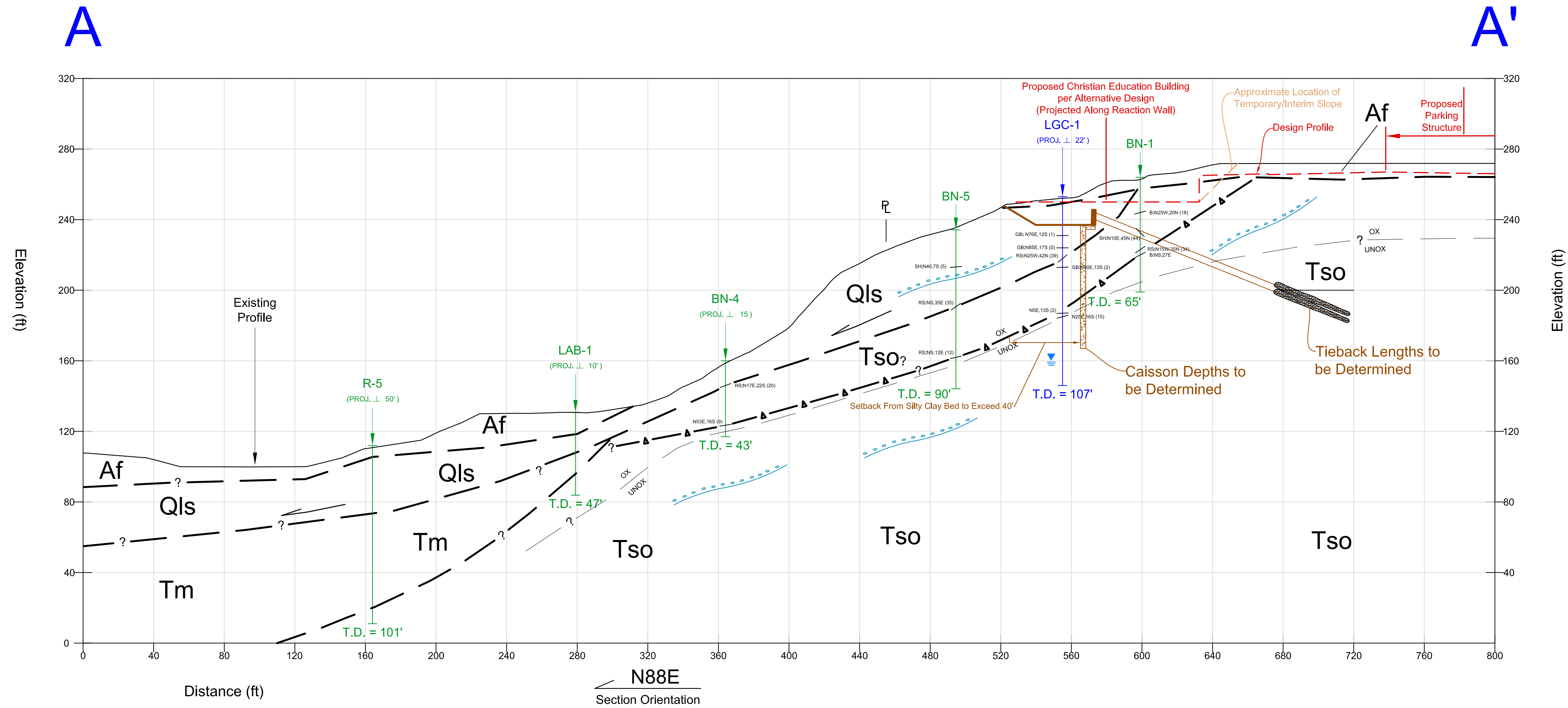

LGC GEOTECHNICAL, INC.
 120 Calle Iglesia, Ste. A
 San Clemente, CA 92672
 TEL (949) 369-6141 FAX (949) 369-6142

**South Shores Church - Alternative Design
 Geotechnical Cross Sections A-A' and B-B'**

CLIENT:
 South Shores Church
 32712 Crown Valley Parkway
 Dana Point, California

PROJECT NAME	South Shores Church
PROJECT NO.	10132-01
ENG. / GEOL.	TJL / KTM
SCALE	1" = 40'
DATE	May 2013

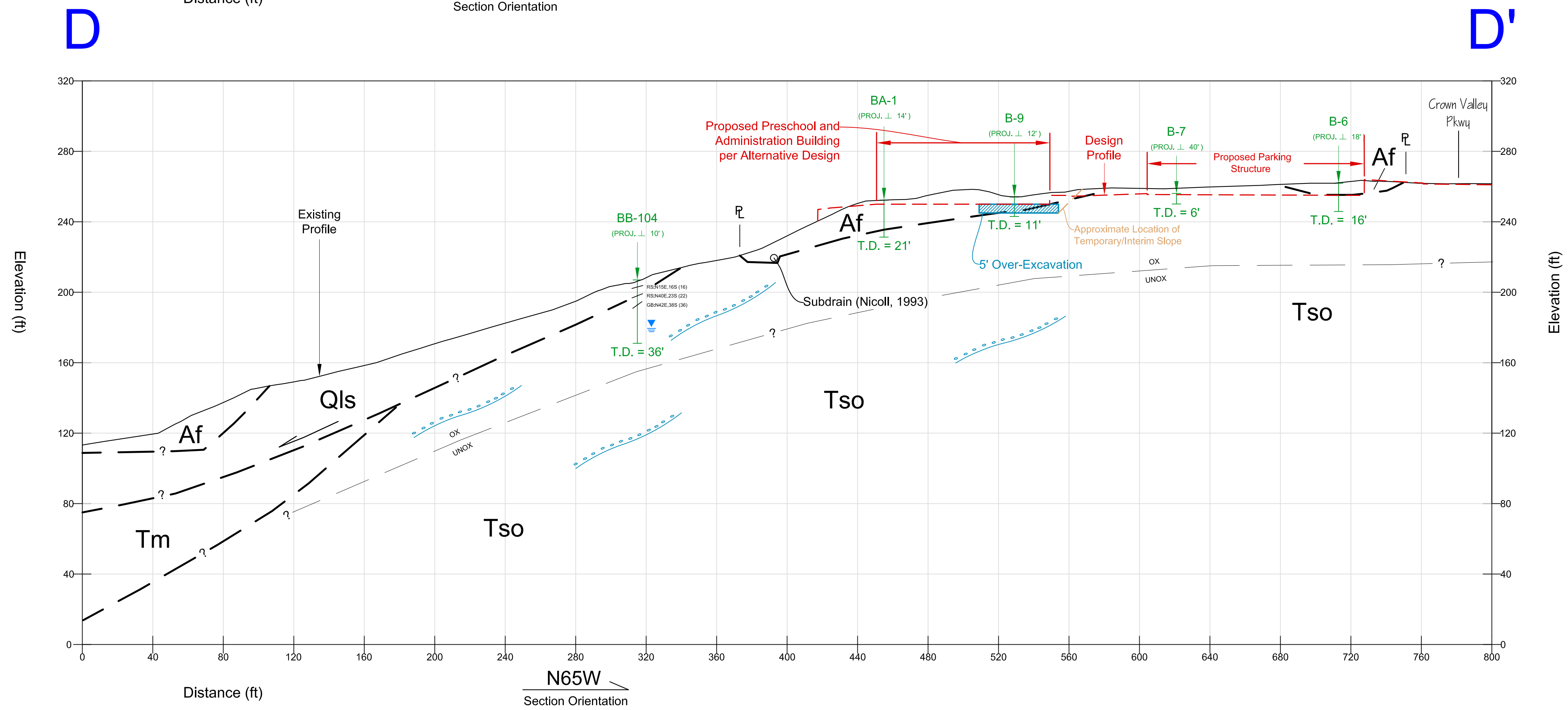
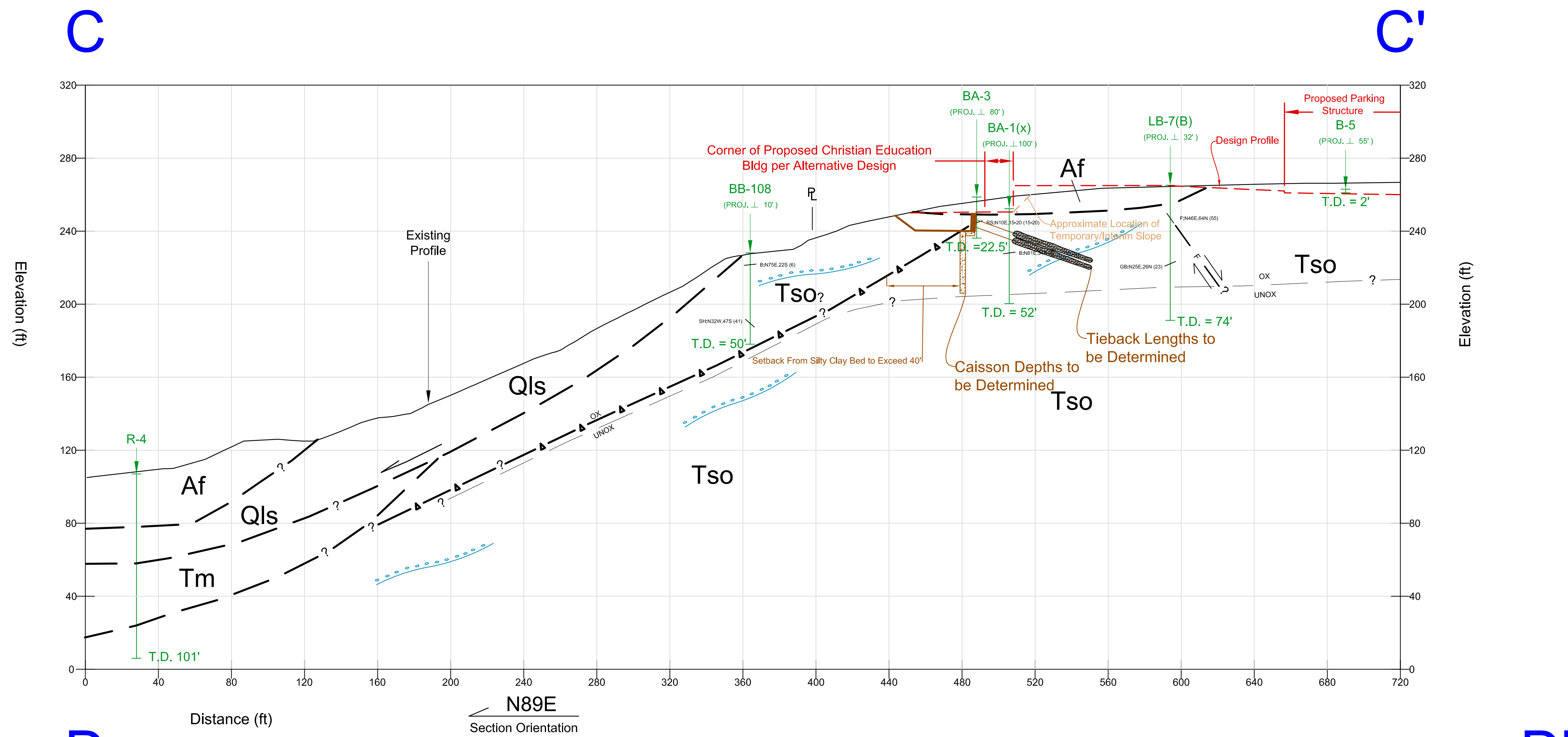

LGC GEOTECHNICAL, INC.
 120 Calle Iglesia, Ste. A
 San Clemente, CA 92672
 TEL (949) 369-6141 FAX (949) 369-6142

**South Shores Church - Alternative Design
 Geotechnical Cross Sections C-C' and D-D'**

CLIENT:
 South Shores Church
 32712 Crown Valley Parkway
 Dana Point, California

PROJECT NAME	South Shores Church
PROJECT NO.	10132-01
ENG. / GEOL.	TJL / KTM
SCALE	1" = 40'
DATE	May 2013

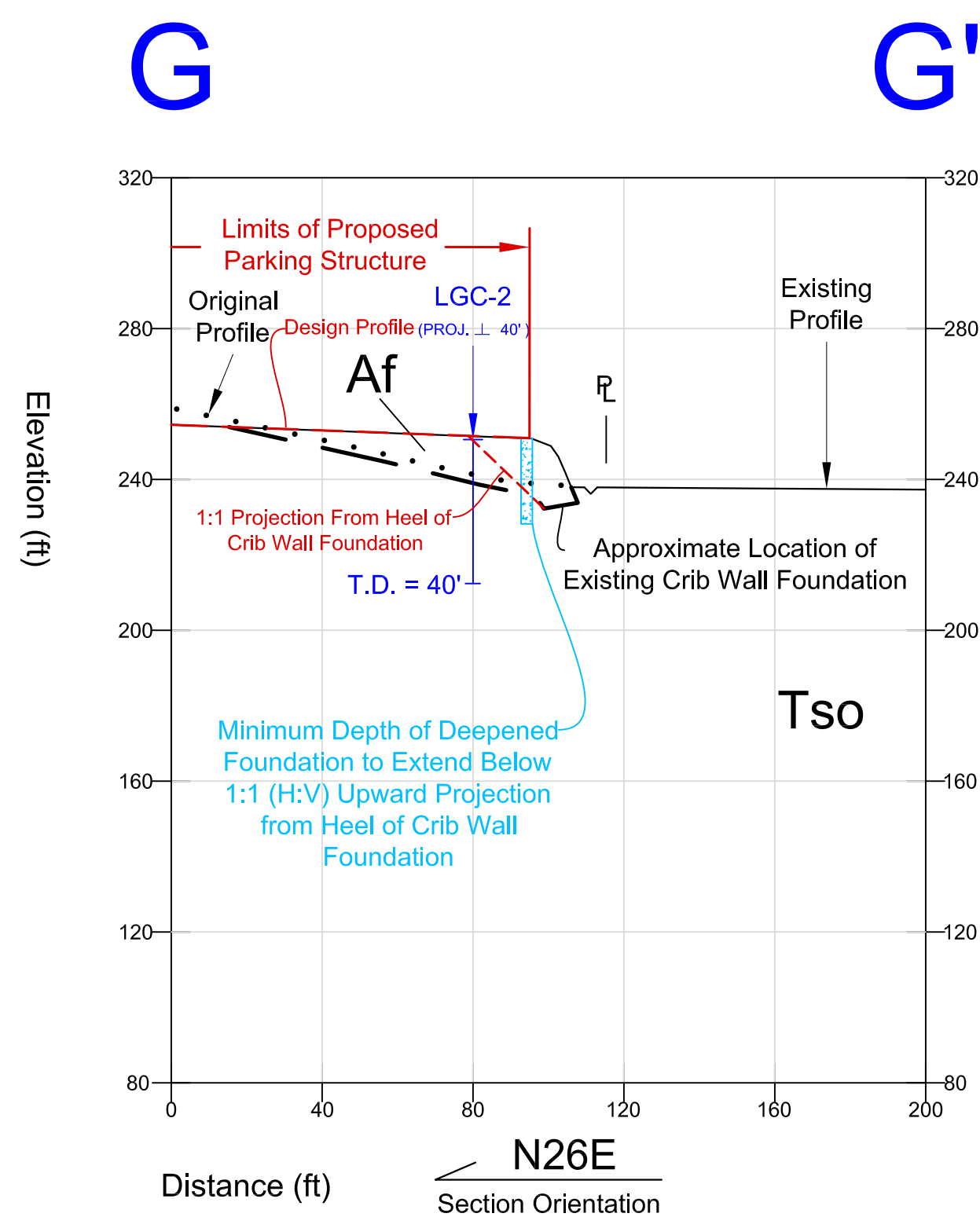
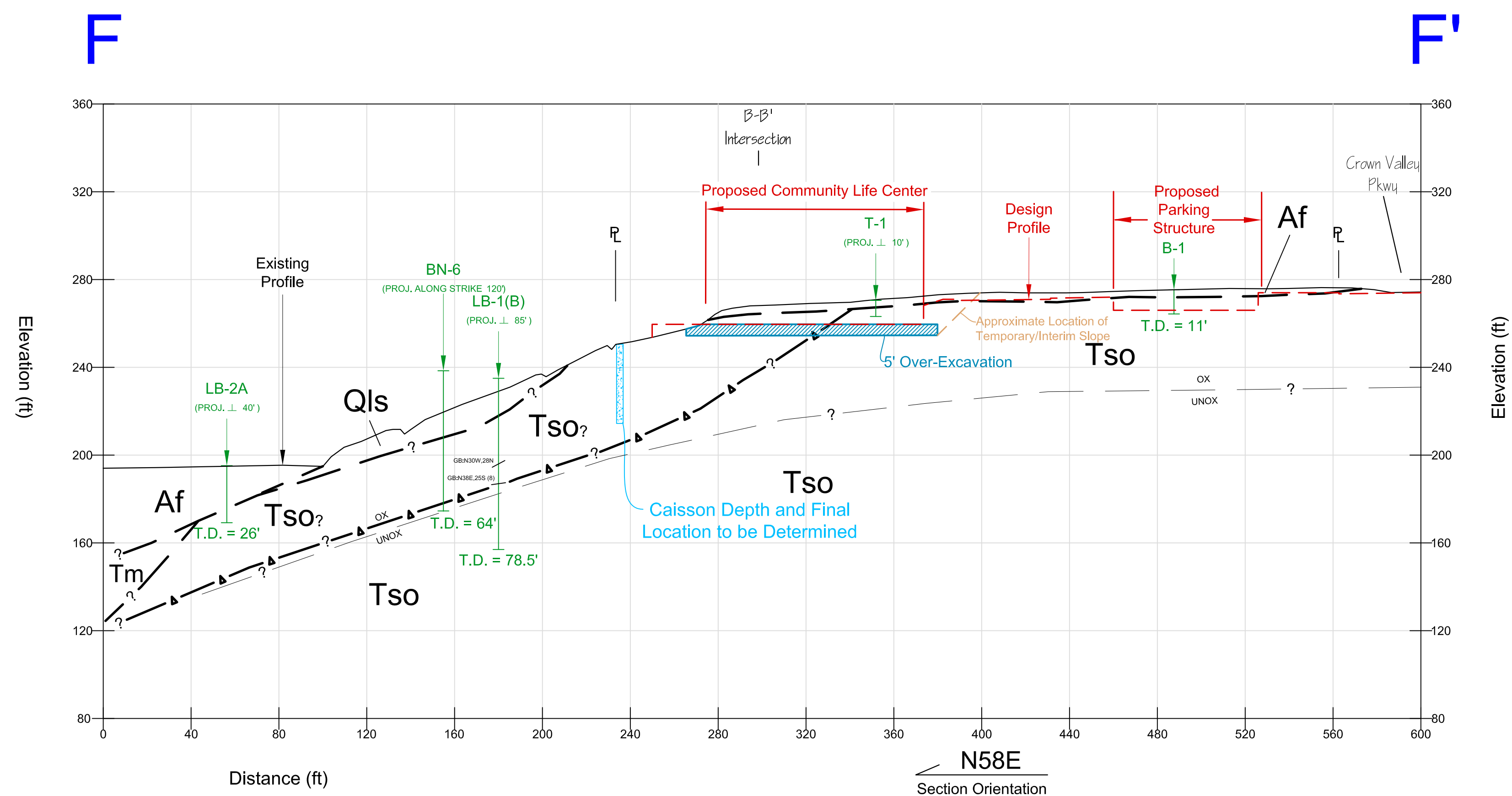
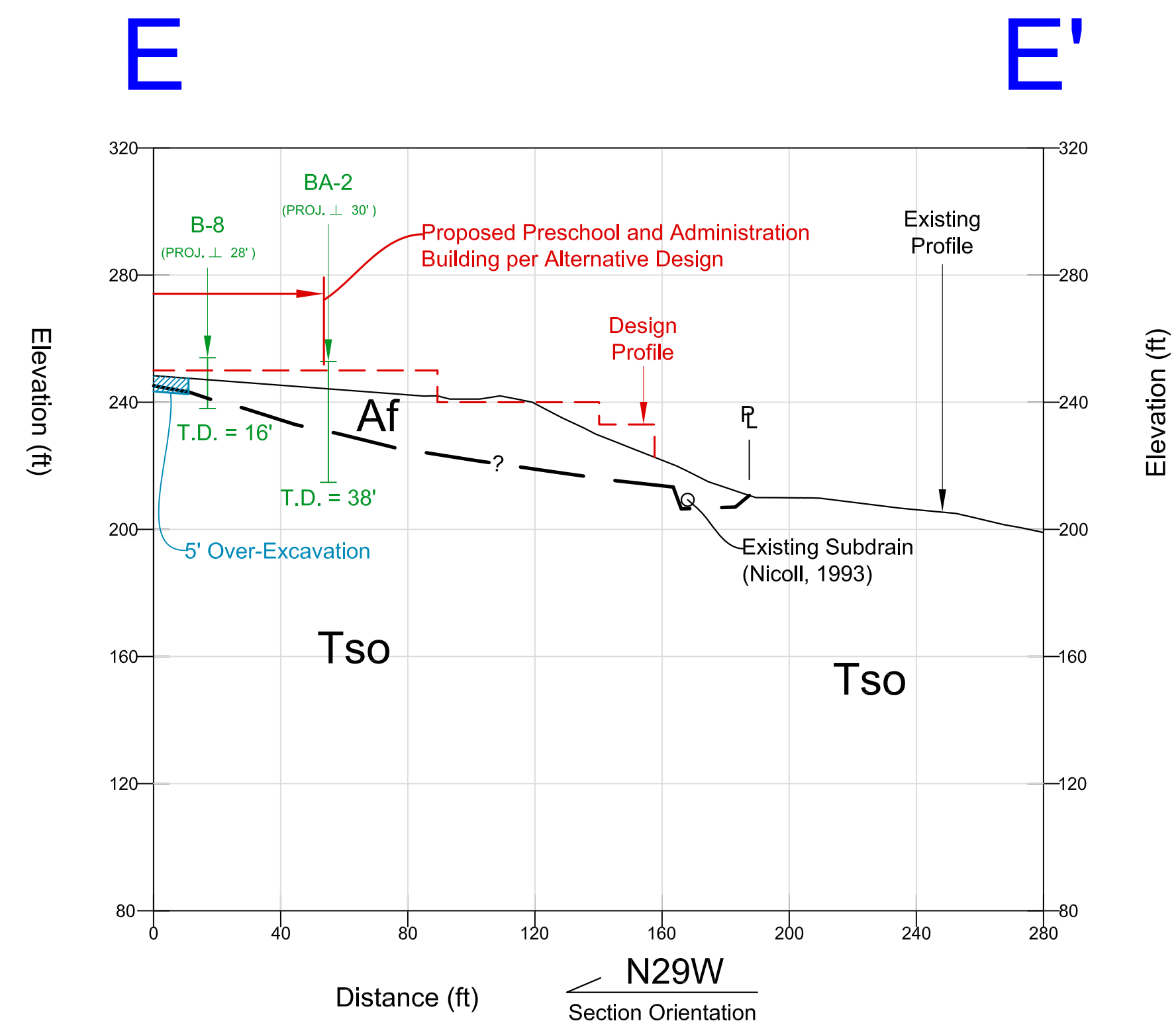

LGC GEOTECHNICAL, INC.
 120 Calle Iglesia, Ste. A
 San Clemente, CA 92672
 TEL (949) 369-6141 FAX (949) 369-6142

**South Shores Church - Alternative Design
 Geotechnical Cross Sections E-E' and F-F'**

CLIENT:
 South Shores Church
 32712 Crown Valley Parkway
 Dana Point, California

PROJECT NAME	South Shores Church
PROJECT NO.	10132-01
ENG. / GEOL.	TJL / KTM
SCALE	1" = 40'
DATE	May 2013

**SHEET
 10 of 10**

December 5, 2013

Project No. 10132-01

Mr. GG Kohlhagen
South Shores Church
32712 Crown Valley Parkway
Dana Point, CA 92629

Subject: *Supplemental Geotechnical Slope Stabilization Design for Proposed Master Plan Alternative, for Environmental Impact Report Purposes, South Shores Church, City of Dana Point, California*

Reference: LGC Geotechnical, 2013, Geotechnical Evaluation and Slope Stabilization Design for Environmental Impact Report Purposes, for Proposed New Structures at the South Shores Church, City of Dana Point, California, Project No. 10132-01, dated May 20, 2013

Introduction

In accordance with your request, LGC Geotechnical, Inc. has provided a supplemental geotechnical slope stabilization design for the proposed Master Plan Alternative design for new structures at the South Shores Church located in the City of Dana Point, California. A complete report of geologic findings, conclusions, and design recommendations, as required for environmental impact report purposes, has been provided in the referenced report by LGC Geotechnical (2013). This supplemental report addresses only a proposed modification to the position of the stabilization system for the Master Plan Alternative. Subsequent, specific design reports will be required prior to actual construction.

In general, all of the geologic findings, conclusions, and preliminary recommendations of the referenced geotechnical evaluation and slope stabilization design report for environmental impact evaluation purposes remain unchanged (LGC Geotechnical, 2013).

Modification to Remedial Measures for Master Plan Alternative

The proposed structures of the Master Plan Alternative design as presented in LGC Geotechnical, 2013, remain unchanged. However, the proposed location of the stabilization system relative to the Master Plan Alternative design has been moved to the modified location presented on the Preliminary Remedial Measures Map, Sheet 2. The presented location of the tieback and caisson system encompasses a larger area of designated Playground for the Preschool into the limits of the area fully stabilized for construction of structures. The southern portion of the stabilization system has been moved slopeward in order to encompass the designated Playground while the northernmost corner has been moved toward the structures in order to streamline the location of the stabilization system relative to the Master Plan Alternative design. Three cross sections, A-A', B-B', and C-C', are affected by this proposed modification, depicted on Sheets 3 and 4 herein.

Slope Stability Analysis

Slope stability analysis was based on modeling of the two-dimensional geotechnical Cross-Sections A-A' through C-C' for the proposed modification to the location of the stabilization system for the Master Plan Alternative design. A conceptual design of caissons (a.k.a. "piers") and tiebacks was utilized in order to stabilize the ground in the same manner as previous analysis presented in LGC Geotechnical, 2013. Caisson depths and tieback array details including unbonded length, strength, and spacing of tiebacks were modeled to increase the static factor of safety to a minimum of 1.5 and pseudo-static factor of safety to a minimum of 1.1. This analysis was performed using the computer program GSTABL7 with STEDwin version 2.002. Block failure modes were analyzed using Janbu's Simplified Method. Pseudo-static analysis was performed utilizing a vertical acceleration coefficient of 0.4g and a horizontal coefficient of 0.15g. The revised engineering analysis has been provided in the attached Slope Stability Analysis. The Preliminary Remedial Measures Map (Sheet 2) and pertinent cross-sections (Sheets 3 and 4) depict the proposed location of the stabilization system.

Minimum Factors of Safety

The line noted as "Approximate Limit of Factor of Safety of 1.5" on the Preliminary Remedial Measures Map (Sheet 2) represents the approximate line of demarcation between portions of the site which will possess slope stability factors of safety of at least 1.5 for static and 1.1 for seismic, and portions of the site that do not. As presented in LGC Geotechnical, 2013, a three-dimensional analysis was performed that indicates the average factor of safety against reactivation of the northeast slope landslide is approximately 1.2. Three-dimensional evaluation is useful and valid for this case of variable factors of safety within an existing landslide because forces of friction (a.k.a. "interslice friction") have a great deal of affect on potential for failure. The boundary conditions add a level of stability to the existing landslide as it is partially buttressed with engineered fill at the northern boundary and has significantly less inclination of slope (and therefore greater stability) at the southern boundary. In our professional opinion, the factor of safety for areas outside of the limits of the stabilization system and designated Playground area remains approximately 1.2 against reactivation of the landslide.

The portion of the designated Playground that is outside of the stabilization system, as defined by Cross Section C-C', is within bedrock and naturally possesses a factor of safety of 1.4 (LGC Geotechnical, 2013). The Playground area as proposed is suitable for its intended use as a non-structural pedestrian use area.

Control of Subsurface Water

As previously discussed in the referenced report (LGC Geotechnical, 2013), infiltration of water to the subsurface is not geotechnically acceptable for the subject site. For the designated Playground surface, the owner may choose to utilize artificial turf (or similar) with no watering needs, or natural turf with a sealed geosynthetic liner system and under-drain to collect water to the site drainage system. Refer to Section 5.11 of the referenced report (LGC Geotechnical, 2013), titled "Subsurface Drainage", for additional recommendations relative to control of subsurface water.

Conclusions

The proposed modification to the location of the stabilization system for the Master Plan Alternative design is overall a minor component of the original geotechnical evaluation for environmental impact report purposes (LGC Geotechnical, 2013). The stabilization system remains within the limits of the originally proposed earthwork limits for the Master Plan Alternative design. The proposed modification is not anticipated to change the conclusions of the original report.

Recommendations

The recommendations of LGC Geotechnical, 2013, remain applicable to the location of the stabilization system presented herein. Preliminary recommendations pertaining to methods of mechanical stabilization and site earthwork are generally unchanged with this location. As stated within the original report, once the finalized plans for the proposed improvements are approved, LGC Geotechnical should perform a grading plan review in order to provide full ground stabilization, foundation, and earthwork construction recommendations. Future versions of the development plan should be provided to this office for geotechnical review for conformance with the geotechnical recommendations provided in LGC Geotechnical, 2013, this report, and any future reports.

Limitations

Our services were performed using the degree of care and skill ordinarily exercised, under similar circumstances, by reputable soils engineers and geologists practicing in this or similar localities. No other warranty, expressed or implied, is made as to the conclusions and professional advice included in this report.

It should be understood that LGC Geotechnical has relied on the accuracy of documents, verbal information, and other material and information provided by you and other associated parties in preparation of this report. LGC Geotechnical makes no warranties or guarantees as to the accuracy or completeness of information obtained from or compiled by others.

Should you have any questions regarding this report, please do not hesitate to contact our office. We appreciate this opportunity to be of service.

Sincerely,

LGC Geotechnical, Inc.



Katie Maes, CEG 2216
Project Geologist



Tim Lawson, GE 2626
Geotechnical Engineer



Attachments: Slope Stability Analyses
Sheets 1 through 4 - Geotechnical Maps and Cross Sections (In Pocket)

Distribution: (4) Addressee (includes 3 wet-signed copies for the City of Dana Point - 1 sealed)

A-A' / Search Along Clay / Caissons and Tiebacks

z:\2010\10132-01 south shores church - dana point\engineering\2013_12\aa'_4c.pl2 Run By: BJE 12/5/2013 01:42PM

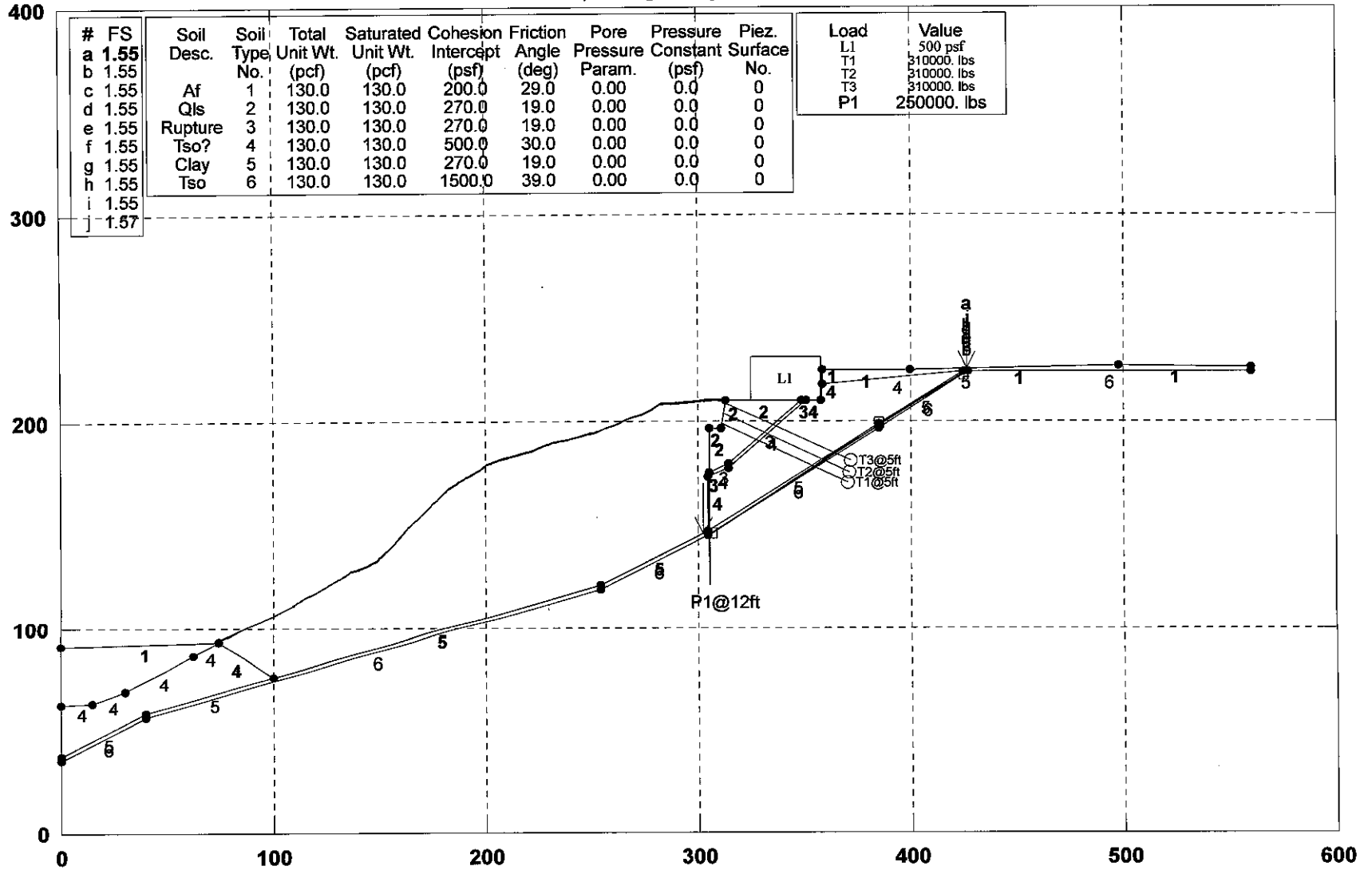

GSTABL7 v.2 FSmin=1.55

Safety Factors Are Calculated By The Simplified Janbu Method for the case of c & phi both > 0

*** GSTABL7 ***

** GSTABL7 by Dr. Garry H. Gregory, Ph.D., P.E., D.GE **

** Original Version 1.0, January 1996; Current Ver. 2.005.2, Jan. 2011 **
 (All Rights Reserved-Unauthorized Use Prohibited)

SLOPE STABILITY ANALYSIS SYSTEM

Modified Bishop, Simplified Janbu, or GLE Method of Slices.
 (Includes Spencer & Morgenstern-Price Type Analysis)
 Including Pier/Pile, Reinforcement, Soil Nail, Tieback,
 Nonlinear Undrained Shear Strength, Curved Phi Envelope,
 Anisotropic Soil, Fiber-Reinforced Soil, Boundary Loads, Water
 Surfaces, Pseudo-Static & Newmark Earthquake, and Applied Forces.

Analysis Run Date: 12/5/2013
 Time of Run: 01:42PM
 Run By: BJE
 Input Data Filename: Z:\2010\10132-01 South Shores Church - Dana Point\Engineerin
 g\2013_12\aa'_4c.
 Output Filename: Z:\2010\10132-01 South Shores Church - Dana Point\Engineerin
 g\2013_12\aa'_4c.OUT
 Unit System: English
 Plotted Output Filename: Z:\2010\10132-01 South Shores Church - Dana Point\Engineerin
 g\2013_12\aa'_4c.PLT

PROBLEM DESCRIPTION: A-A' / Search Along Clay /
 Caissons and Tiebacks

BOUNDARY COORDINATES

17 Top Boundaries
 37 Total Boundaries

Boundary No.	X-Left (ft)	Y-Left (ft)	X-Right (ft)	Y-Right (ft)	Soil Type Below Bnd
1	0.00	92.00	74.00	94.00	1
2	74.00	94.00	100.00	76.60	4
3	100.00	76.60	254.00	122.00	5
4	254.00	122.00	304.70	147.35	5
5	304.70	147.35	304.80	173.90	4
6	304.80	173.90	304.90	175.90	3
7	304.90	175.90	305.00	197.00	2
8	305.00	197.00	311.00	197.00	2
9	311.00	197.00	313.00	210.00	2
10	313.00	210.00	348.70	210.00	2
11	348.70	210.00	350.70	210.00	3
12	350.70	210.00	358.00	210.00	4
13	358.00	210.00	358.10	218.00	4
14	358.10	218.00	358.20	225.00	1
15	358.20	225.00	400.00	225.00	1
16	400.00	225.00	498.00	227.00	1
17	498.00	227.00	560.00	226.00	1
18	358.10	218.00	425.00	224.00	4
19	425.00	224.00	427.00	224.00	5
20	427.00	224.00	560.00	224.00	6
21	0.00	63.00	15.00	64.00	4
22	15.00	64.00	30.00	69.00	4
23	30.00	69.00	62.00	87.00	4
24	62.00	87.00	74.00	94.00	4
25	304.90	175.90	314.00	180.00	3
26	314.00	180.00	348.70	210.00	3
27	0.00	38.00	40.00	59.00	5
28	40.00	59.00	100.00	76.60	5
29	304.80	173.90	314.00	178.00	4
30	314.00	178.00	350.70	210.00	4
31	304.70	147.35	385.00	199.00	5
32	385.00	199.00	425.00	224.00	5
33	0.00	36.00	40.00	57.00	6
34	40.00	57.00	254.00	120.00	6
35	254.00	120.00	304.60	145.35	6
36	304.60	145.35	385.00	197.00	6
37	385.00	197.00	427.00	224.00	6

Default Y-Origin = 0.00(ft)
 Default X-Plus Value = 0.00(ft)
 Default Y-Plus Value = 0.00(ft)

ISOTROPIC SOIL PARAMETERS

Soil Type	Total Unit Wt.	Saturated Unit Wt.	Intercept (pcf)	Friction Angle (psf)	Pore Pressure Param. (deg)	Pressure Constant (psf)	Piez. Surface
1	130.0	130.0	200.0	29.0	0.00	0.00	0
2	130.0	130.0	270.0	19.0	0.00	0.00	0
3	130.0	130.0	270.0	19.0	0.00	0.00	0
4	130.0	130.0	500.0	30.0	0.00	0.00	0
5	130.0	130.0	270.0	19.0	0.00	0.00	0
6	130.0	130.0	1500.0	39.0	0.00	0.00	0

BOUNDARY LOAD(S)

1 Load(s) Specified

Load No.	X-Left (ft)	X-Right (ft)	Intensity (psf)	Deflection (deg)
1	325.00	358.00	500.0	0.0

NOTE - Intensity Is Specified As A Uniformly Distributed Force Acting On A Horizontally Projected Surface.

TIEBACK LOAD(S)

3 Tieback Load(s) Specified

Tieback No.	X-Pos (ft)	Y-Pos (ft)	Load (lbs)	Spacing (ft)	Inclination (deg)	Length (ft)	Force Method
1	311.23	198.50	310000.0	5.0	25.00	65.0	2
2	312.00	203.50	310000.0	5.0	25.00	65.0	2
3	312.77	208.50	310000.0	5.0	25.00	65.0	2

NOTE - An Equivalent Line Load Is Calculated For Each Row Of Tiebacks Assuming A Uniform Distribution Of Load Horizontally Between Individual Tiebacks. Force Method 1 Considers Only Tangential Tieback Forces. Force Method 2 Considers Both Tangential and Normal Tieback Forces. Force Method 3 Considers Only Normal Tieback Forces. Force Method 4 Limits Normal and Tangential Tieback-Force Distribution to 1.5 Times the Tieback Inclination, or to 30 Degrees Below (Left of) the Tieback-Failure Surface Intersection, Whichever is Greater.

PIER/PILE LOAD(S)

1 Pier/Pile Load(s) Specified

Pier/Pile No.	X-Pos (ft)	Y-Pos (ft)	Load (lbs)	Spacing (ft)	Inclination (deg)	Length (ft)
1	305.10	197.00	250000.0	12.0	90.00	75.0

NOTE - An Equivalent Line Load Is Calculated For Each Row Of Piers/Piles Assuming A Uniform Distribution Of Load Horizontally Between Individual Piers/Piles.

Janbus Empirical Coef is being used for the case of c & phi both > 0
 A Critical Failure Surface Searching Method, Using A Random Technique For Generating Sliding Block Surfaces, Has Been Specified.

5000 Trial Surfaces Have Been Generated.
 3 Boxes Specified For Generation Of Central Block Base
 Length Of Line Segments For Active And Passive Portions Of Sliding Block Is 80.0

Box No.	X-Left (ft)	Y-Left (ft)	X-Right (ft)	Y-Right (ft)	Height (ft)
1	304.80	146.35	308.80	146.35	5.00
2	383.00	199.00	387.00	199.00	5.00
3	423.00	222.00	427.00	222.00	5.00

The Factor Of Safety For The Trial Failure Surface Defined By The Coordinates Listed Below Is Misleading.

Failure Surface Defined By 5 Coordinate Points

Point No.	X-Surf (ft)	Y-Surf (ft)
1	304.71	149.92
2	308.29	147.84
3	385.13	198.29
4	423.44	220.63
5	423.45	225.48

Factor Of Safety For The Preceding Specified Surface = -12.240
 The Factor Of Safety For The Trial Failure Surface Defined By The Coordinates Listed Below Is Misleading.

Failure Surface Defined By 5 Coordinate Points

Point No.	X-Surf (ft)	Y-Surf (ft)
1	304.71	149.92
2	308.29	147.84
3	385.13	198.29
4	423.44	220.63
5	423.45	225.48

1 304.71 149.92
 2 308.29 147.84
 3 385.13 198.29
 4 423.44 220.63
 5 423.45 225.48
 Factor Of Safety For The Preceding Specified Surface =-12.240
 The Factor Of Safety For The Trial Failure Surface Defined
 By The Coordinates Listed Below Is Misleading.
 Failure Surface Defined By 5 Coordinate Points
 Point X-Surf Y-Surf
 No. (ft) (ft)
 1 304.71 149.92
 2 308.29 147.84
 3 385.13 198.29
 4 423.44 220.63
 5 423.45 225.48
 Factor Of Safety For The Preceding Specified Surface =-12.240
 The Factor Of Safety For The Trial Failure Surface Defined
 By The Coordinates Listed Below Is Misleading.
 Failure Surface Defined By 5 Coordinate Points
 Point X-Surf Y-Surf
 No. (ft) (ft)
 1 304.71 149.92
 2 308.29 147.84
 3 385.13 198.29
 4 423.44 220.63
 5 423.45 225.48
 Factor Of Safety For The Preceding Specified Surface =-12.240
 The Factor Of Safety For The Trial Failure Surface Defined
 By The Coordinates Listed Below Is Misleading.
 Failure Surface Defined By 5 Coordinate Points
 Point X-Surf Y-Surf
 No. (ft) (ft)
 1 304.71 149.92
 2 308.29 147.84
 3 385.13 198.29
 4 423.44 220.63
 5 423.45 225.48
 Factor Of Safety For The Preceding Specified Surface =-12.240
 The Factor Of Safety For The Trial Failure Surface Defined
 By The Coordinates Listed Below Is Misleading.
 Failure Surface Defined By 5 Coordinate Points
 Point X-Surf Y-Surf
 No. (ft) (ft)
 1 304.71 149.92
 2 308.29 147.84
 3 385.13 198.29
 4 423.44 220.63
 5 423.45 225.48
 Factor Of Safety For The Preceding Specified Surface =-12.240
 The Factor Of Safety For The Trial Failure Surface Defined
 By The Coordinates Listed Below Is Misleading.
 Failure Surface Defined By 5 Coordinate Points
 Point X-Surf Y-Surf
 No. (ft) (ft)
 1 304.71 149.92
 2 308.29 147.84
 3 385.13 198.29
 4 423.44 220.63
 5 423.45 225.48
 Factor Of Safety For The Preceding Specified Surface =-12.240
 The Factor Of Safety For The Trial Failure Surface Defined
 By The Coordinates Listed Below Is Misleading.
 Failure Surface Defined By 5 Coordinate Points
 Point X-Surf Y-Surf
 No. (ft) (ft)
 1 304.71 149.92
 2 308.29 147.84
 3 385.13 198.29
 4 423.44 220.63

5 423.45 225.48
 Factor Of Safety For The Preceding Specified Surface =-12.240
 The Factor Of Safety For The Trial Failure Surface Defined
 By The Coordinates Listed Below Is Misleading.
 Failure Surface Defined By 5 Coordinate Points
 Point X-Surf Y-Surf
 No. (ft) (ft)
 1 304.71 149.92
 2 308.29 147.84
 3 385.13 198.29
 4 423.44 220.63
 5 423.45 225.48
 Factor Of Safety For The Preceding Specified Surface =-12.240
 The Factor Of Safety For The Trial Failure Surface Defined
 By The Coordinates Listed Below Is Misleading.
 Failure Surface Defined By 5 Coordinate Points
 Point X-Surf Y-Surf
 No. (ft) (ft)
 1 304.71 149.92
 2 308.29 147.84
 3 385.13 198.29
 4 423.44 220.63
 5 423.45 225.48
 Factor Of Safety For The Preceding Specified Surface =-12.240
 Following Are Displayed The Ten Most Critical Of The Trial
 Failure Surfaces Evaluated. They Are
 Ordered - Most Critical First.
 * * Safety Factors Are Calculated By The Simplified Janbu Method * *
 Total Number of Trial Surfaces Attempted = 5000
 Number of Trial Surfaces With Misleading FS = 10
 Number of Trial Surfaces With Valid FS = 4990
 Percentage of Trial Surfaces With Non-Valid FS Solutions
 of the Total Attempted = 0.2 %
 Statistical Data On All Valid FS Values:
 FS Max = 13.156 FS Min = 1.549 FS Ave = 2.854
 Standard Deviation = 0.826 Coefficient of Variation = 28.94 %
 Failure Surface Specified By 5 Coordinate Points
 Point X-Surf Y-Surf
 No. (ft) (ft)
 1 302.247 146.124
 2 304.828 145.664
 3 384.729 198.380
 4 424.602 223.613
 5 426.276 225.536
 Factor of Safety
 *** 1.549 ***
 Individual data on the 21 slices

Slice No.	Width (ft)	Weight (lbs)	Water Force		Tie Force Norm (lbs)	Tie Force Tan (lbs)	Earthquake Force		Surcharge Load (lbs)
			Top (lbs)	Bot (lbs)			Hor (lbs)	Ver (lbs)	
1	2.5	265.2	0.0	0.0	0.	0.	0.0	0.0	0.0
2	0.1	194.3	0.0	0.0	61.	3.	0.0	0.0	0.0
3	0.0	104.1	0.0	0.0	17.	1.	0.0	0.0	0.0
4	0.1	275.8	0.0	0.0	40.	0.	0.0	0.0	0.0
5	0.1	529.3	0.0	0.0	56.	0.	0.0	0.0	0.0
6	6.0	38410.0	0.0	0.0	4176.	0.	0.0	0.0	0.0
7	2.0	13807.2	0.0	0.0	1829.	0.	0.0	0.0	0.0
8	1.0	7619.9	0.0	0.0	1007.	0.	0.0	0.0	0.0
9	11.0	78158.6	0.0	0.0	15754.	0.	0.0	0.0	0.0
10	23.7	133128.3	0.0	0.0	62681.	2313.	0.0	0.0	11850.0
11	2.0	9030.2	0.0	0.0	5320.	1910.	0.0	0.0	1000.0
12	7.3	30048.7	0.0	0.0	18067.	8707.	0.0	0.0	3650.0
13	0.1	431.9	0.0	0.0	229.	133.	0.0	0.0	0.0
14	0.1	528.6	0.0	0.0	229.	133.	0.0	0.0	0.0
15	26.5	121990.7	0.0	0.0	42499.	39696.	0.0	0.0	0.0
16	0.3	934.0	0.0	0.0	281.	376.	0.0	0.0	0.0
17	15.0	42320.2	0.0	0.0	12474.	19295.	0.0	0.0	0.0
18	24.6	30135.7	0.0	0.0	11129.	24415.	0.0	0.0	0.0
19	0.3	59.6	0.0	0.0	165.	224.	0.0	0.0	0.0

20 0.1 13.7 0.0 0.0 42. 58. 0.0 0.0 0.0
 21 1.3 132.2 0.0 0.0 822. 1130. 0.0 0.0 0.0

Failure Surface Specified By 5 Coordinate Points

Point No.	X-Surf (ft)	Y-Surf (ft)
1	302.247	146.124
2	304.828	145.664
3	384.729	198.380
4	424.602	223.613
5	426.276	225.536

Factor of Safety
 *** 1.549 ***

Failure Surface Specified By 5 Coordinate Points

Point No.	X-Surf (ft)	Y-Surf (ft)
1	302.247	146.124
2	304.828	145.664
3	384.729	198.380
4	424.602	223.613
5	426.276	225.536

Factor of Safety
 *** 1.549 ***

Failure Surface Specified By 5 Coordinate Points

Point No.	X-Surf (ft)	Y-Surf (ft)
1	302.247	146.124
2	304.828	145.664
3	384.729	198.380
4	424.602	223.613
5	426.276	225.536

Factor of Safety
 *** 1.549 ***

Failure Surface Specified By 5 Coordinate Points

Point No.	X-Surf (ft)	Y-Surf (ft)
1	302.247	146.124
2	304.828	145.664
3	384.729	198.380
4	424.602	223.613
5	426.276	225.536

Factor of Safety
 *** 1.549 ***

Failure Surface Specified By 5 Coordinate Points

Point No.	X-Surf (ft)	Y-Surf (ft)
1	302.247	146.124
2	304.828	145.664
3	384.729	198.380
4	424.602	223.613
5	426.276	225.536

Factor of Safety
 *** 1.549 ***

Failure Surface Specified By 5 Coordinate Points

Point No.	X-Surf (ft)	Y-Surf (ft)
1	302.247	146.124
2	304.828	145.664
3	384.729	198.380
4	424.602	223.613
5	426.276	225.536

Factor of Safety
 *** 1.549 ***

Failure Surface Specified By 5 Coordinate Points

Point No.	X-Surf (ft)	Y-Surf (ft)
1	302.247	146.124
2	304.828	145.664
3	384.729	198.380
4	424.602	223.613
5	426.276	225.536

Factor of Safety
 *** 1.549 ***

Failure Surface Specified By 5 Coordinate Points

Point No.	X-Surf (ft)	Y-Surf (ft)
1	302.247	146.124
2	304.828	145.664
3	384.729	198.380
4	424.602	223.613
5	426.276	225.536

Factor of Safety
 *** 1.549 ***

Failure Surface Specified By 5 Coordinate Points

Point No.	X-Surf (ft)	Y-Surf (ft)
1	303.212	146.606
2	305.055	145.908
3	383.518	197.764
4	424.454	222.764
5	427.064	225.552

Factor of Safety
 *** 1.566 ***

**** END OF GSTABL7 OUTPUT ****

A-A' / Search Along Clay / Caissons and Tiebacks / Pseudo

z:\2010\10132-01 south shores church - dana point\engineering\2013_12\aa'_4cp.pl2 Run By: BJE 12/5/2013 01:43PM

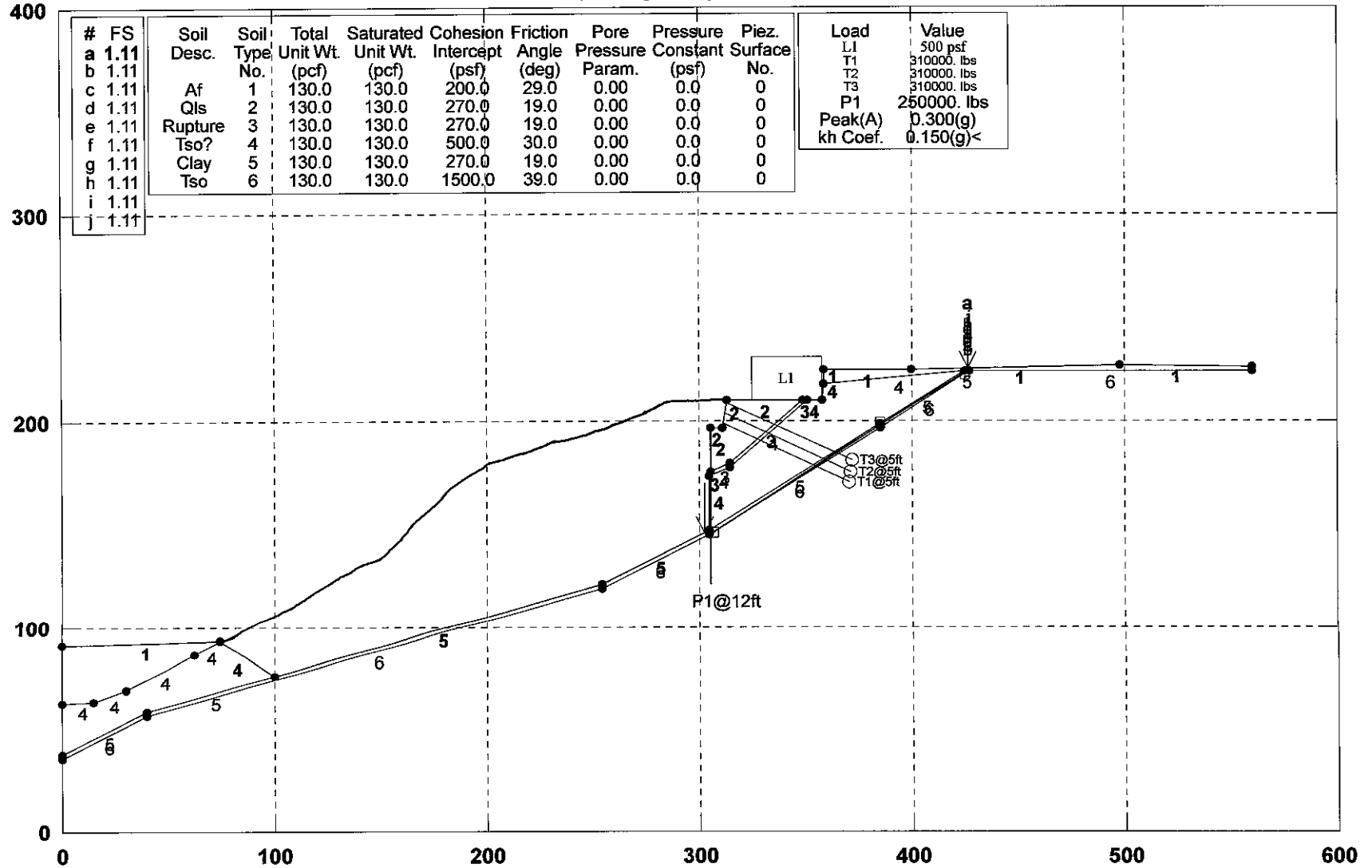

GSTABL7 v.2 FSmin=1.11

Safety Factors Are Calculated By The Simplified Janbu Method for the case of c & phi both > 0

*** GSTABL7 ***

** GSTABL7 by Dr. Garry H. Gregory, Ph.D., P.E., D.GE **
 ** Original Version 1.0, January 1996; Current Ver. 2.005.2, Jan. 2011 **
 (All Rights Reserved-Unauthorizd Use Prohibited)

SLOPE STABILITY ANALYSIS SYSTEM

Modified Bishop, Simplified Janbu, or GLE Method of Slices.
 (Includes Spencer & Morgenstern-Price Type Analysis)
 Including Pier/Pile, Reinforcement, Soil Nail, Tieback,
 Nonlinear Undrained Shear Strength, Curved Phi Envelope,
 Anisotropic Soil, Fiber-Reinforced Soil, Boundary Loads, Water
 Surfaces, Pseudo-Static & Newmark Earthquake, and Applied Forces.

Analysis Run Date: 12/5/2013
 Time of Run: 01:43PM
 Run By: BJE
 Input Data Filename: Z:\2010\10132-01 South Shores Church - Dana Point\Engineerin
 g\2013_12\aa'_4cp.
 Output Filename: Z:\2010\10132-01 South Shores Church - Dana Point\Engineerin
 g\2013_12\aa'_4cp.OUT
 Unit System: English
 Plotted Output Filename: Z:\2010\10132-01 South Shores Church - Dana Point\Engineerin
 g\2013_12\aa'_4cp.PLT

PROBLEM DESCRIPTION: A-A' / Search Along Clay /
 Caissons and Tiebacks / Pseudo

BOUNDARY COORDINATES

17 Top Boundaries

37 Total Boundaries

Boundary No.	X-Left (ft)	Y-Left (ft)	X-Right (ft)	Y-Right (ft)	Soil Type Below Bnd
1	0.00	92.00	74.00	94.00	1
2	74.00	94.00	100.00	76.60	4
3	100.00	76.60	254.00	122.00	5
4	254.00	122.00	304.70	147.35	5
5	304.70	147.35	304.80	173.90	4
6	304.80	173.90	304.90	175.90	3
7	304.90	175.90	305.00	197.00	2
8	305.00	197.00	311.00	197.00	2
9	311.00	197.00	313.00	210.00	2
10	313.00	210.00	348.70	210.00	2
11	348.70	210.00	350.70	210.00	3
12	350.70	210.00	358.00	210.00	4
13	358.00	210.00	358.10	218.00	4
14	358.10	218.00	358.20	225.00	1
15	358.20	225.00	400.00	225.00	1
16	400.00	225.00	498.00	227.00	1
17	498.00	227.00	560.00	226.00	1
18	358.10	218.00	425.00	224.00	4
19	425.00	224.00	427.00	224.00	5
20	427.00	224.00	560.00	224.00	6
21	0.00	63.00	15.00	64.00	4
22	15.00	64.00	30.00	69.00	4
23	30.00	69.00	62.00	87.00	4
24	62.00	87.00	74.00	94.00	4
25	304.90	175.90	314.00	180.00	3
26	314.00	180.00	348.70	210.00	3
27	0.00	38.00	40.00	59.00	5
28	40.00	59.00	100.00	76.60	5
29	304.80	173.90	314.00	178.00	4
30	314.00	178.00	350.70	210.00	4
31	304.70	147.35	385.00	199.00	5
32	385.00	199.00	425.00	224.00	5
33	0.00	36.00	40.00	57.00	6
34	40.00	57.00	254.00	120.00	6
35	254.00	120.00	304.60	145.35	6
36	304.60	145.35	385.00	197.00	6
37	385.00	197.00	427.00	224.00	6

Default Y-Origin = 0.00(ft)
 Default X-Plus Value = 0.00(ft)
 Default Y-Plus Value = 0.00(ft)

ISOTROPIC SOIL PARAMETERS

6 Type(s) of Soil

Soil No.	Total (pcf)	Saturated (pcf)	Intercept (psf)	Friction Angle (deg)	Pore Pressure Param. (psf)	Pressure Constant (psf)	Piez. Surface No.
1	130.0	130.0	200.0	29.0	0.00	0.0	0
2	130.0	130.0	270.0	19.0	0.00	0.0	0
3	130.0	130.0	270.0	19.0	0.00	0.0	0
4	130.0	130.0	500.0	30.0	0.00	0.0	0
5	130.0	130.0	270.0	19.0	0.00	0.0	0
6	130.0	130.0	1500.0	39.0	0.00	0.0	0

BOUNDARY LOAD(S)

1 Load(s) Specified

Load No.	X-Left (ft)	X-Right (ft)	Intensity (psf)	Deflection (deg)
1	325.00	358.00	500.0	0.0

NOTE - Intensity Is Specified As A Uniformly Distributed Force Acting On A Horizontally Projected Surface.

Specified Peak Ground Acceleration Coefficient (A) = 0.300(g)
 Specified Horizontal Earthquake Coefficient (kh) = 0.150(g)
 Specified Vertical Earthquake Coefficient (kv) = 0.000(g)
 Specified Seismic Pore-Pressure Factor = 0.000

TIEBACK LOAD(S)

3 Tieback Load(s) Specified

Tieback No.	X-Pos (ft)	Y-Pos (ft)	Load (lbs)	Spacing (ft)	Inclination (deg)	Length (ft)	Force Method
1	311.23	198.50	310000.0	5.0	25.00	65.0	2
2	312.00	203.50	310000.0	5.0	25.00	65.0	2
3	312.77	208.50	310000.0	5.0	25.00	65.0	2

NOTE - An Equivalent Line Load Is Calculated For Each Row Of Tiebacks Assuming A Uniform Distribution Of Load Horizontally Between Individual Tiebacks. Force Method 1 Considers Only Tangential Tieback Forces. Force Method 2 Considers Both Tangential and Normal Tieback Forces. Force Method 3 Considers Only Normal Tieback Forces. Force Method 4 Limits Normal and Tangential Tieback-Force Distribution to 1.5 Times the Tieback Inclination, or to 30 Degrees Below (Left of) the Tieback-Failure Surface Intersection, Whichever is Greater.

PIER/PILE LOAD(S)

1 Pier/Pile Load(s) Specified

Pier/Pile No.	X-Pos (ft)	Y-Pos (ft)	Load (lbs)	Spacing (ft)	Inclination (deg)	Length (ft)
1	305.10	197.00	250000.0	12.0	90.00	75.0

NOTE - An Equivalent Line Load Is Calculated For Each Row Of Piers/Piles Assuming A Uniform Distribution Of Load Horizontally Between Individual Piers/Piles.

Janbus Empirical Coef is being used for the case of c & phi both > 0
 A Critical Failure Surface Searching Method, Using A Random Technique For Generating Sliding Block Surfaces, Has Been Specified.

5000 Trial Surfaces Have Been Generated.
 3 Boxes Specified For Generation Of Central Block Base
 Length Of Line Segments For Active And Passive Portions Of Sliding Block Is 80.0

Box No.	X-Left (ft)	Y-Left (ft)	X-Right (ft)	Y-Right (ft)	Height (ft)
1	304.80	146.35	308.80	146.35	5.00
2	383.00	199.00	387.00	199.00	5.00
3	423.00	222.00	427.00	222.00	5.00

Following Are Displayed The Ten Most Critical Of The Trial Failure Surfaces Evaluated. They Are Ordered - Most Critical First.

* * Safety Factors Are Calculated By The Simplified Janbu Method * *
 Total Number of Trial Surfaces Attempted = 5000
 Number of Trial Surfaces With Valid FS = 5000
 Statistical Data On All Valid FS Values:
 FS Max = 10.812 FS Min = 1.105 FS Ave = 2.007
 Standard Deviation = 0.631 Coefficient of Variation = 31.42 %
 Failure Surface Specified By 5 Coordinate Points

Point No.	X-Surf (ft)	Y-Surf (ft)
1		
2		
3		
4		
5		

Slice No.	Width (ft)	Weight (lbs)	Water Top (lbs)	Water Bot (lbs)	Tie Force (lbs)	Tie Force (lbs)	Earthquake Force (lbs)	Surcharge (lbs)	Hor Load (lbs)	Ver Load (lbs)
1	2.5	265.2	0.0	0.0	0.0	0.0	39.8	0.0	0.0	0.0
2	0.1	194.3	0.0	0.0	61.0	3.0	29.1	0.0	0.0	0.0
3	0.0	104.1	0.0	0.0	17.0	1.0	15.6	0.0	0.0	0.0
4	0.1	275.8	0.0	0.0	40.0	0.0	41.4	0.0	0.0	0.0
5	0.1	529.3	0.0	0.0	56.0	0.0	79.4	0.0	0.0	0.0
6	6.0	38410.0	0.0	0.0	4176.0	0.0	5761.5	0.0	0.0	0.0
7	2.0	13807.2	0.0	0.0	1829.0	0.0	2071.1	0.0	0.0	0.0
8	1.0	7619.9	0.0	0.0	1007.0	0.0	1143.0	0.0	0.0	0.0
9	11.0	78158.6	0.0	0.0	15754.0	0.0	11723.8	0.0	0.0	0.0
10	23.7	133128.3	0.0	0.0	62681.0	2313.0	19969.2	0.0	11850.0	0.0
11	2.0	9030.2	0.0	0.0	5320.0	1910.0	1354.5	0.0	1000.0	0.0
12	7.3	30048.7	0.0	0.0	18067.0	8707.0	4507.3	0.0	3650.0	0.0
13	0.1	431.9	0.0	0.0	229.0	133.0	64.8	0.0	0.0	0.0
14	0.1	528.6	0.0	0.0	229.0	133.0	79.3	0.0	0.0	0.0
15	26.5	121990.7	0.0	0.0	42499.0	39696.0	18298.6	0.0	0.0	0.0
16	0.3	934.0	0.0	0.0	281.0	376.0	140.1	0.0	0.0	0.0
17	15.0	42320.2	0.0	0.0	12474.0	19295.0	6348.0	0.0	0.0	0.0
18	24.6	30135.7	0.0	0.0	11129.0	24415.0	4520.4	0.0	0.0	0.0
19	0.3	59.6	0.0	0.0	165.0	224.0	8.9	0.0	0.0	0.0
20	0.1	13.7	0.0	0.0	42.0	58.0	2.1	0.0	0.0	0.0
21	1.3	132.2	0.0	0.0	822.0	1130.0	19.8	0.0	0.0	0.0

Point No.	X-Surf (ft)	Y-Surf (ft)
1	302.247	146.124
2	304.828	145.664
3	384.729	198.380
4	424.602	223.613
5	426.276	225.536

Factor of Safety
*** 1.105 ***

Failure Surface Specified By 5 Coordinate Points

Point No.	X-Surf (ft)	Y-Surf (ft)
1	302.247	146.124
2	304.828	145.664
3	384.729	198.380
4	424.602	223.613
5	426.276	225.536

Factor of Safety
*** 1.105 ***

Failure Surface Specified By 5 Coordinate Points

Point No.	X-Surf (ft)	Y-Surf (ft)
1	302.247	146.124
2	304.828	145.664
3	384.729	198.380
4	424.602	223.613
5	426.276	225.536

Factor of Safety
*** 1.105 ***

Failure Surface Specified By 5 Coordinate Points

Point No.	X-Surf (ft)	Y-Surf (ft)
1	302.247	146.124
2	304.828	145.664
3	384.729	198.380
4	424.602	223.613
5	426.276	225.536

Factor of Safety
*** 1.105 ***

Failure Surface Specified By 5 Coordinate Points

Point No.	X-Surf (ft)	Y-Surf (ft)
1	302.247	146.124
2	304.828	145.664
3	384.729	198.380
4	424.602	223.613

5	426.276	225.536
---	---------	---------

Factor of Safety
*** 1.105 ***

Failure Surface Specified By 5 Coordinate Points

Point No.	X-Surf (ft)	Y-Surf (ft)
1	302.247	146.124
2	304.828	145.664
3	384.729	198.380
4	424.602	223.613
5	426.276	225.536

Factor of Safety
*** 1.105 ***

Failure Surface Specified By 5 Coordinate Points

Point No.	X-Surf (ft)	Y-Surf (ft)
1	302.247	146.124
2	304.828	145.664
3	384.729	198.380
4	424.602	223.613
5	426.276	225.536

Factor of Safety
*** 1.105 ***

Failure Surface Specified By 5 Coordinate Points

Point No.	X-Surf (ft)	Y-Surf (ft)
1	302.247	146.124
2	304.828	145.664
3	384.729	198.380
4	424.602	223.613
5	426.276	225.536

Factor of Safety
*** 1.105 ***

Failure Surface Specified By 5 Coordinate Points

Point No.	X-Surf (ft)	Y-Surf (ft)
1	302.247	146.124
2	304.828	145.664
3	384.729	198.380
4	424.602	223.613
5	426.276	225.536

Factor of Safety
*** 1.105 ***

Failure Surface Specified By 5 Coordinate Points

Point No.	X-Surf (ft)	Y-Surf (ft)
1	303.212	146.606
2	305.055	145.908
3	383.518	197.764
4	424.454	222.764
5	427.064	225.552

Factor of Safety
*** 1.114 ***

**** END OF GSTABL7 OUTPUT ****

B-B' / Search Along Clay / Caissons and Tiebacks

z:\2010\10132-01 south shores church - dana point\engineering\2013_12\bb'1.pl2 Run By: BJE 12/5/2013 01:44PM

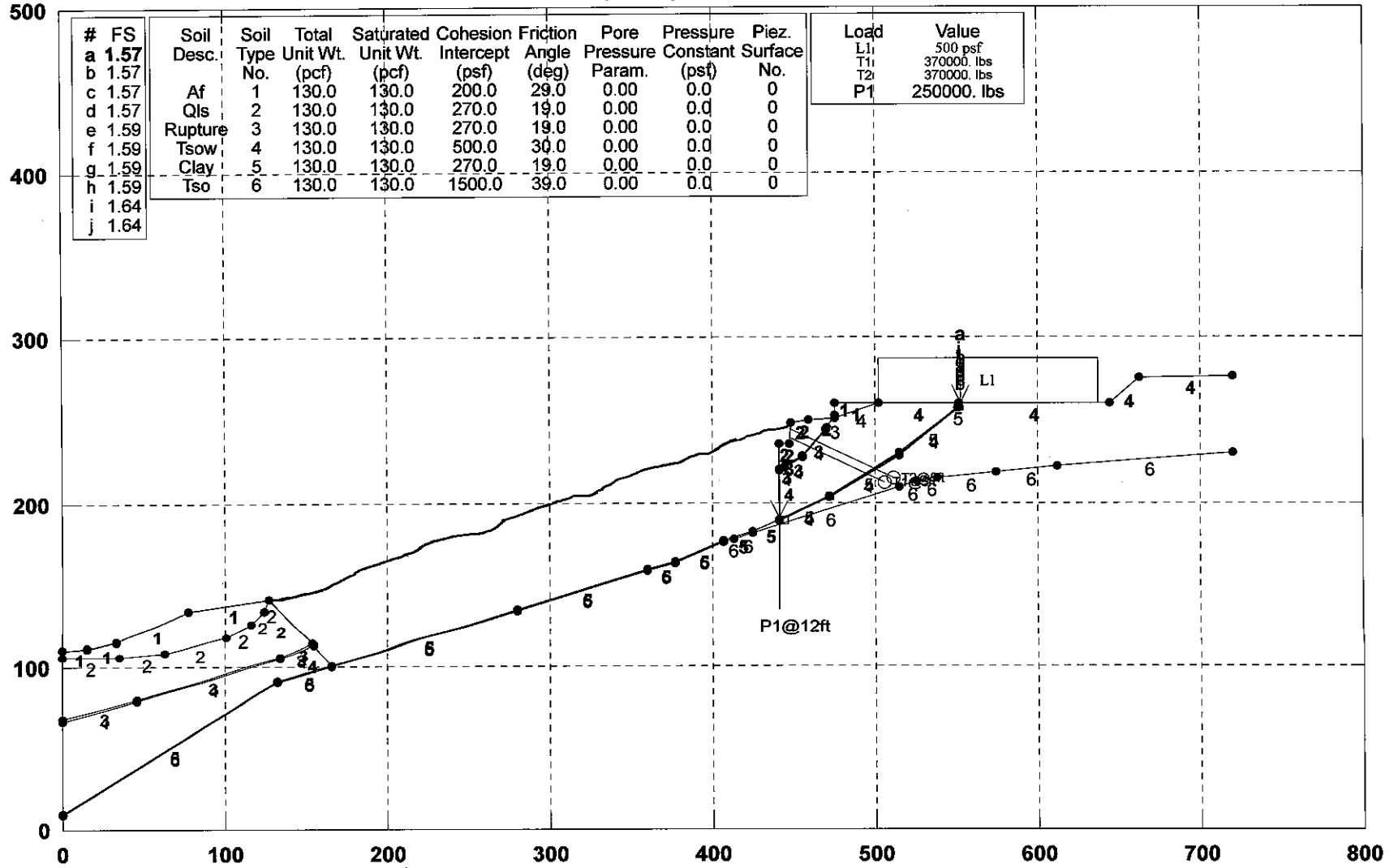

GSTABL7 v.2 FSmin=1.57

Safety Factors Are Calculated By The Simplified Janbu Method for the case of c & phi both > 0

*** GSTABL7 ***

** GSTABL7 by Dr. Garry H. Gregory, Ph.D., P.E., D.GE **
 ** Original Version 1.0, January 1996; Current Ver. 2.005.2, Jan. 2011 **
 (All Rights Reserved-Unauthorizd Use Prohibited)

SLOPE STABILITY ANALYSIS SYSTEM

Modified Bishop, Simplified Janbu, or GLE Method of Slices.
 (Includes Spencer & Morgenstern-Price Type Analysis)
 Including Pier/Pile, Reinforcement, Soil Nail, Tieback,
 Nonlinear Undrained Shear Strength, Curved Phi Envelope,
 Anisotropic Soil, Fiber-Reinforced Soil, Boundary Loads, Water
 Surfaces, Pseudo-Static & Newmark Earthquake, and Applied Forces.

Analysis Run Date: 12/5/2013
 Time of Run: 01:44PM
 Run By: BJE
 Input Data Filename: Z:\2010\10132-01 South Shores Church - Dana Point\Engineerin
 g\2013_12\bb'1.
 Output Filename: Z:\2010\10132-01 South Shores Church - Dana Point\Engineerin
 g\2013_12\bb'1.OUT
 Unit System: English
 Plotted Output Filename: Z:\2010\10132-01 South Shores Church - Dana Point\Engineerin
 g\2013_12\bb'1.PLT

PROBLEM DESCRIPTION: B-B' / Search Along Clay /
 Caissons and Tiebacks

BOUNDARY COORDINATES

26 Top Boundaries

70 Total Boundaries

Boundary No.	X-Left (ft)	Y-Left (ft)	X-Right (ft)	Y-Right (ft)	Soil Type Below Bnd
1	0.00	111.00	15.00	112.00	1
2	15.00	112.00	33.00	115.00	1
3	33.00	115.00	77.00	135.00	1
4	77.00	135.00	127.00	142.00	1
5	127.00	142.00	154.00	114.00	2
6	154.00	114.00	155.00	113.00	3
7	155.00	113.00	166.00	101.00	4
8	166.00	101.00	280.00	136.00	5
9	280.00	136.00	360.00	160.00	5
10	360.00	160.00	377.00	165.00	5
11	377.00	165.00	407.00	177.00	5
12	407.00	177.00	425.00	183.00	5
13	425.00	183.00	440.70	190.00	5
14	440.70	190.00	440.80	219.20	4
15	440.80	219.20	440.90	220.20	3
16	440.90	220.20	441.00	236.00	2
17	441.00	236.00	447.00	236.00	2
18	447.00	236.00	448.00	248.00	2
19	448.00	248.00	459.00	250.00	2
20	459.00	250.00	475.00	251.00	2
21	475.00	251.00	475.10	260.00	1
22	475.10	260.00	502.00	260.00	1
23	502.00	260.00	552.00	260.00	4
24	552.00	260.00	644.00	260.00	4
25	644.00	260.00	662.00	275.00	4
26	662.00	275.00	720.00	276.00	4
27	720.00	276.00	720.00	260.00	4
28	720.00	260.00	720.00	257.00	5
29	720.00	257.00	720.00	222.00	3
30	720.00	222.00	720.00	229.00	3
31	720.00	229.00	720.00	245.00	3
32	720.00	245.00	720.00	253.00	3
33	720.00	253.00	720.00	221.00	4
34	720.00	221.00	720.00	228.00	4
35	720.00	228.00	720.00	244.00	4
36	720.00	244.00	720.00	106.00	2
37	720.00	106.00	720.00	109.00	2
38	720.00	109.00	720.00	118.00	2
39	720.00	118.00	720.00	127.00	2
40	720.00	127.00	720.00	135.00	2

41	124.00	135.00	127.00	142.00	2
42	0.00	68.00	46.00	80.00	3
43	46.00	80.00	134.00	106.00	3
44	134.00	106.00	154.00	114.00	3
45	0.00	67.00	46.00	79.00	4
46	46.00	79.00	134.00	105.00	4
47	134.00	105.00	155.00	113.00	4
48	0.00	10.00	132.00	92.00	5
49	132.00	92.00	166.00	101.00	5
50	407.00	177.00	425.00	183.00	5
51	440.70	190.00	472.00	204.00	5
52	472.00	204.00	515.00	230.00	5
53	515.00	230.00	551.00	257.00	5
54	0.00	9.00	132.00	91.00	6
55	132.00	91.00	166.00	100.00	6
56	166.00	100.00	280.00	135.00	6
57	280.00	135.00	360.00	159.00	6
58	360.00	159.00	377.00	164.00	6
59	377.00	164.00	407.00	176.00	6
60	407.00	176.00	413.00	178.00	6
61	413.00	178.00	425.00	182.00	6
62	440.60	189.00	472.00	203.00	4
63	472.00	203.00	515.00	229.00	4
64	515.00	229.00	552.00	257.00	4
65	425.00	182.00	515.00	210.00	6
66	515.00	210.00	526.00	213.00	6
67	526.00	213.00	538.00	215.00	6
68	538.00	215.00	574.00	219.00	6
69	574.00	219.00	612.00	222.00	6
70	612.00	222.00	720.00	230.00	6

Default Y-Origin = 0.00(ft)
 Default X-Plus Value = 0.00(ft)
 Default Y-Plus Value = 0.00(ft)

ISOTROPIC SOIL PARAMETERS

6 Type(s) of Soil

Type No.	Total (pcf)	Saturated (pcf)	Cohesion (psf)	Friction Angle (deg)	Pore Pressure Param. (psf)	Pressure Constant (psf)	Piez. Surface
1	130.0	130.0	200.0	29.0	0.00	0.0	0
2	130.0	130.0	270.0	19.0	0.00	0.0	0
3	130.0	130.0	270.0	19.0	0.00	0.0	0
4	130.0	130.0	500.0	30.0	0.00	0.0	0
5	130.0	130.0	270.0	19.0	0.00	0.0	0
6	130.0	130.0	1500.0	39.0	0.00	0.0	0

BOUNDARY LOAD(S)

1 Load(s) Specified

Load No.	X-Left (ft)	X-Right (ft)	Intensity (psf)	Deflection (deg)
1	502.00	637.00	500.0	0.0

NOTE - Intensity Is Specified As A Uniformly Distributed Force Acting On A Horizontally Projected Surface.

TIEBACK LOAD(S)

2 Tieback Load(s) Specified

Tieback No.	X-Pos (ft)	Y-Pos (ft)	Load (lbs)	Spacing (ft)	Inclination (deg)	Length (ft)	Force Method
1	447.29	239.50	370000.0	5.0	25.00	65.0	2
2	447.71	244.50	370000.0	5.0	25.00	70.0	2

NOTE - An Equivalent Line Load Is Calculated For Each Row Of Tiebacks Assuming A Uniform Distribution Of Load Horizontally Between Individual Tiebacks. Force Method 1 Considers Only Tangential Tieback Forces.

Force Method 2 Considers Both Tangential and Normal Tieback Forces.

Force Method 3 Considers Only Normal Tieback Forces.

Force Method 4 Limits Normal and Tangential Tieback-Force Distribution to 1.5 Times the Tieback Inclination, or to 30 Degrees Below (Left of) the Tieback-Failure Surface Intersection, Whichever is Greater.

PIER/PILE LOAD(S)

1 Pier/Pile Load(s) Specified

Pier/Pile No.	X-Pos (ft)	Y-Pos (ft)	Load (lbs)	Spacing (ft)	Inclination (deg)	Length (ft)
1	441.10	236.00	250000.0	12.0	90.00	100.0

NOTE - An Equivalent Line Load Is Calculated For Each Row Of Piers/Piles Assuming A Uniform Distribution Of Load Horizontally Between Individual Piers/Piles.

Janbus Empirical Coef is being used for the case of c & phi both > 0
 A Critical Failure Surface Searching Method, Using A Random Technique For Generating Sliding Block Surfaces, Has Been Specified.

8000 Trial Surfaces Have Been Generated.
 4 Boxes Specified For Generation Of Central Block Base
 Length Of Line Segments For Active And Passive Portions Of Sliding Block Is 60.0

Box No.	X-Left (ft)	Y-Left (ft)	X-Right (ft)	Y-Right (ft)	Height (ft)
1	440.80	189.50	446.00	189.50	5.00
2	470.00	204.00	474.00	204.00	5.00
3	513.00	230.00	517.00	230.00	5.00
4	550.00	257.00	554.00	257.00	2.00

The Factor Of Safety For The Trial Failure Surface Defined By The Coordinates Listed Below Is Misleading.
 Failure Surface Defined By 6 Coordinate Points

Point No.	X-Surf (ft)	Y-Surf (ft)
1	440.71	192.61
2	444.93	188.41
3	471.32	202.59
4	516.13	229.81
5	550.48	257.21
6	550.49	260.00

Factor Of Safety For The Preceding Specified Surface = -3.219
 The Factor Of Safety For The Trial Failure Surface Defined By The Coordinates Listed Below Is Misleading.

Point No.	X-Surf (ft)	Y-Surf (ft)
1	440.71	192.61
2	444.93	188.41
3	471.32	202.59
4	516.13	229.81
5	550.48	257.21
6	550.49	260.00

Factor Of Safety For The Preceding Specified Surface = -3.219
 The Factor Of Safety For The Trial Failure Surface Defined By The Coordinates Listed Below Is Misleading.

Point No.	X-Surf (ft)	Y-Surf (ft)
1	440.71	192.61
2	444.93	188.41
3	471.32	202.59
4	516.13	229.81
5	550.48	257.21
6	550.49	260.00

Factor Of Safety For The Preceding Specified Surface = -3.219
 The Factor Of Safety For The Trial Failure Surface Defined By The Coordinates Listed Below Is Misleading.

Point No.	X-Surf (ft)	Y-Surf (ft)
1	440.71	192.61
2	444.93	188.41
3	471.32	202.59
4	516.13	229.81
5	550.48	257.21
6	550.49	260.00

Factor Of Safety For The Preceding Specified Surface = -3.219
 Following Are Displayed The Ten Most Critical Of The Trial Failure Surfaces Evaluated. They Are Ordered - Most Critical First.

* * * Safety Factors Are Calculated By The Simplified Janbu Method * * *
 Total Number of Trial Surfaces Attempted = 8000

Number of Trial Surfaces with Misleading FS = 4
 Number of Trial Failure Surfaces is Greater Than 5000.
 Statistical Data on FS Values are Not Generated.
 To Generate Stastical Data, Reduce Number of Trial Failure Surfaces to 5000 or less.
 Failure Surface Specified By 6 Coordinate Points

Point No.	X-Surf (ft)	Y-Surf (ft)
1	440.702	190.706
2	441.187	190.225
3	471.530	203.424
4	513.184	228.103
5	552.135	257.892
6	553.013	260.000

Factor of Safety
 *** 1.574 ***

Individual data on the 22 slices										
Slice No.	Width (ft)	Weight (lbs)	Water Force (lbs)		Tie Force Norm (lbs)	Tie Force Tan (lbs)	Earthquake Force (lbs)		Surcharge Load (lbs)	
			Top	Bot			Hor	Ver		
1	0.1	181.4	0.0	0.0	0.0	0.0	0.0	0.0	0.0	0.0
2	0.1	378.8	0.0	0.0	0.0	0.0	0.0	0.0	0.0	0.0
3	0.1	489.4	0.0	0.0	0.0	0.0	0.0	0.0	0.0	0.0
4	0.2	1109.9	0.0	0.0	0.0	0.0	0.0	0.0	0.0	0.0
5	0.6	3386.4	0.0	0.0	0.0	0.0	0.0	0.0	0.0	0.0
6	3.2	18893.5	0.0	0.0	1939.0	0.0	0.0	0.0	0.0	0.0
7	2.0	11357.2	0.0	0.0	1430.0	0.0	0.0	0.0	0.0	0.0
8	1.0	6373.8	0.0	0.0	786.0	0.0	0.0	0.0	0.0	0.0
9	7.0	49072.2	0.0	0.0	6919.0	0.0	0.0	0.0	0.0	0.0
10	4.0	27317.2	0.0	0.0	5110.0	0.0	0.0	0.0	0.0	0.0
11	11.0	71468.8	0.0	0.0	17849.0	37.0	0.0	0.0	0.0	0.0
12	1.5	9476.7	0.0	0.0	2751.0	364.0	0.0	0.0	0.0	0.0
13	0.5	2885.9	0.0	0.0	920.0	30.0	0.0	0.0	0.0	0.0
14	3.0	18063.1	0.0	0.0	6005.0	453.0	0.0	0.0	0.0	0.0
15	0.1	649.9	0.0	0.0	203.0	23.0	0.0	0.0	0.0	0.0
16	26.9	162584.4	0.0	0.0	50864.0	23368.0	0.0	0.0	0.0	0.0
17	11.2	51194.8	0.0	0.0	13563.0	12799.0	0.0	0.0	5592.2	0.0
18	1.8	7365.1	0.0	0.0	2230.0	1961.0	0.0	0.0	907.8	0.0
19	34.4	77594.6	0.0	0.0	25284.0	33492.0	0.0	0.0	17188.0	0.0
20	2.6	1096.6	0.0	0.0	1182.0	2105.0	0.0	0.0	1312.0	0.0
21	0.1	38.0	0.0	0.0	59.0	107.0	0.0	0.0	67.7	0.0
22	0.9	120.2	0.0	0.0	1374.0	849.0	0.0	0.0	438.7	0.0

Failure Surface Specified By 6 Coordinate Points

Point No.	X-Surf (ft)	Y-Surf (ft)
1	440.702	190.706
2	441.187	190.225
3	471.530	203.424
4	513.184	228.103
5	552.135	257.892
6	553.013	260.000

Factor of Safety
 *** 1.574 ***

Failure Surface Specified By 6 Coordinate Points

Point No.	X-Surf (ft)	Y-Surf (ft)
1	440.702	190.706
2	441.187	190.225
3	471.530	203.424
4	513.184	228.103
5	552.135	257.892
6	553.013	260.000

Factor of Safety
 *** 1.574 ***

Failure Surface Specified By 6 Coordinate Points

Point No.	X-Surf (ft)	Y-Surf (ft)
1	440.702	190.706
2	441.187	190.225

3	471.530	203.424
4	513.184	228.103
5	552.135	257.892
6	553.013	260.000

Factor of Safety
 *** 1.574 ***

Failure Surface Specified By 6 Coordinate Points

Point No.	X-Surf (ft)	Y-Surf (ft)
1	440.702	190.580
2	441.497	189.878
3	472.050	203.897
4	515.235	229.709
5	550.968	256.113
6	552.776	260.000

Factor of Safety
 *** 1.585 ***

Failure Surface Specified By 6 Coordinate Points

Point No.	X-Surf (ft)	Y-Surf (ft)
1	440.702	190.580
2	441.497	189.878
3	472.050	203.897
4	515.235	229.709
5	550.968	256.113
6	552.776	260.000

Factor of Safety
 *** 1.585 ***

Failure Surface Specified By 6 Coordinate Points

Point No.	X-Surf (ft)	Y-Surf (ft)
1	440.702	190.580
2	441.497	189.878
3	472.050	203.897
4	515.235	229.709
5	550.968	256.113
6	552.776	260.000

Factor of Safety
 *** 1.585 ***

Failure Surface Specified By 6 Coordinate Points

Point No.	X-Surf (ft)	Y-Surf (ft)
1	440.702	190.580
2	441.497	189.878
3	472.050	203.897
4	515.235	229.709
5	550.968	256.113
6	552.776	260.000

Factor of Safety
 *** 1.585 ***

Failure Surface Specified By 6 Coordinate Points

Point No.	X-Surf (ft)	Y-Surf (ft)
1	440.403	189.868
2	440.994	189.375
3	470.944	202.965
4	514.661	228.659
5	550.175	256.771
6	551.957	260.000

Factor of Safety
 *** 1.638 ***

Failure Surface Specified By 6 Coordinate Points

Point No.	X-Surf (ft)	Y-Surf (ft)
1	440.403	189.868
2	440.994	189.375
3	470.944	202.965
4	514.661	228.659
5	550.175	256.771
6	551.957	260.000

Factor of Safety
 *** 1.638 ***
 **** END OF GSTABL7 OUTPUT ****

B-B' / Search Along Clay / Caissons and Tiebacks / Pseudo

z:\2010\10132-01 south shores church - dana point\engineering\2013_12\bb'1p.pl2 Run By: BJE 12/5/2013 01:45PM

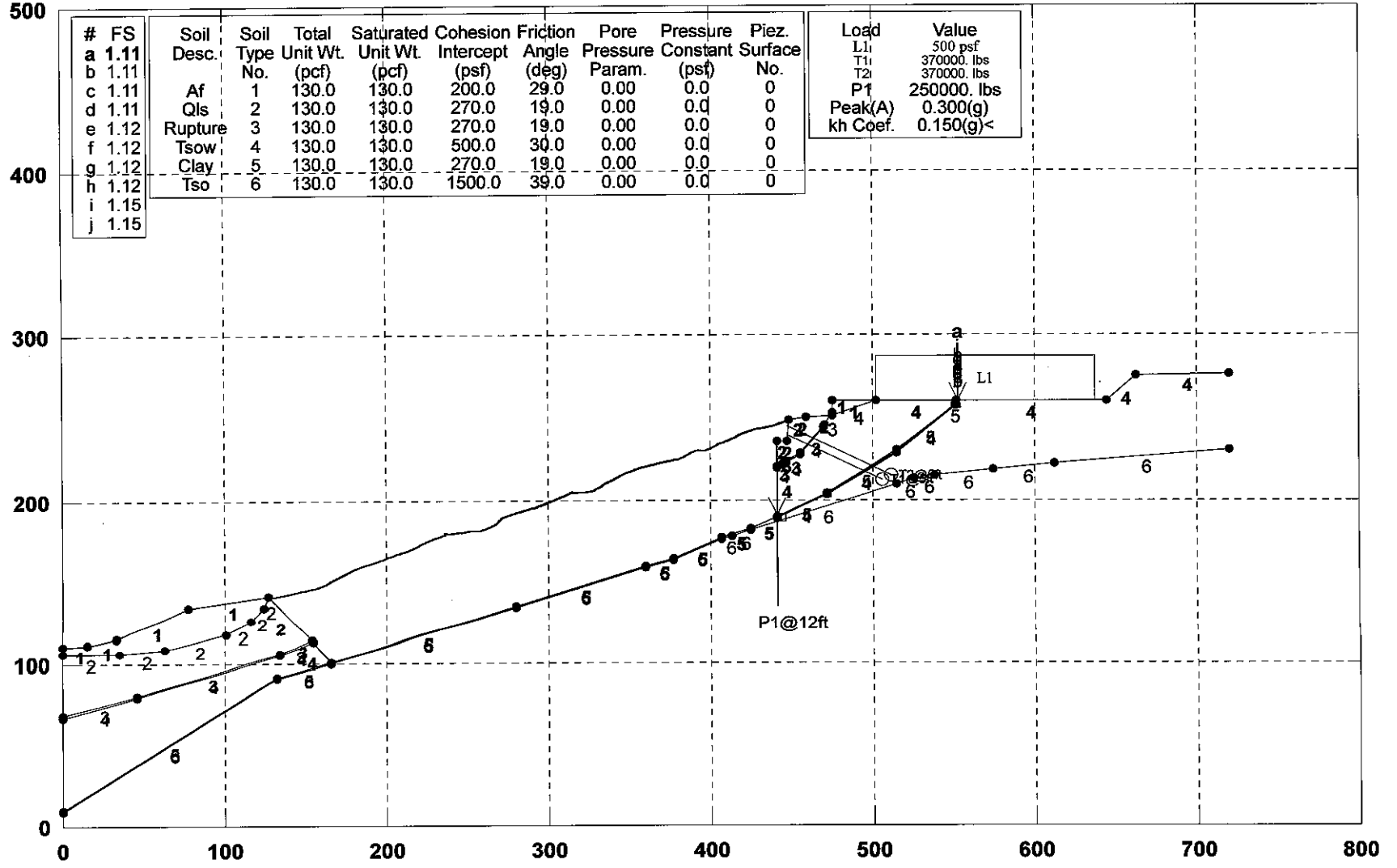

GSTABL7 v.2 FSmin=1.11

Safety Factors Are Calculated By The Simplified Janbu Method for the case of c & phi both > 0

*** GSTABL7 ***

** GSTABL7 by Dr. Garry H. Gregory, Ph.D., P.E., D.GE **

** Original Version 1.0, January 1996; Current Ver. 2.005.2, Jan. 2011 **
(All Rights Reserved-Unauthorizd Use Prohibited)

SLOPE STABILITY ANALYSIS SYSTEM

Modified Bishop, Simplified Janbu, or GLE Method of Slices.
(Includes Spencer & Morgenstern-Price Type Analysis)
Including Pier/Pile, Reinforcement, Soil Nail, Tieback,
Nonlinear Undrained Shear Strength, Curved Phi Envelope,
Anisotropic Soil, Fiber-Reinforced Soil, Boundary Loads, Water
Surfaces, Pseudo-Static & Newmark Earthquake, and Applied Forces.

Analysis Run Date: 12/5/2013
Time of Run: 01:45PM
Run By: BJE
Input Data Filename: Z:\2010\10132-01 South Shores Church - Dana Point\Engineerin
g\2013_12\bb'lp.
Output Filename: Z:\2010\10132-01 South Shores Church - Dana Point\Engineerin
g\2013_12\bb'lp.OUT
Unit System: English
Plotted Output Filename: Z:\2010\10132-01 South Shores Church - Dana Point\Engineerin
g\2013_12\bb'lp.PLT

PROBLEM DESCRIPTION: B-B' / Search Along Clay /
Caissons and Tiebacks / Pseudo

BOUNDARY COORDINATES

26 Top Boundaries

70 Total Boundaries

Boundary No.	X-Left (ft)	Y-Left (ft)	X-Right (ft)	Y-Right (ft)	Soil Type Below Bnd
1	0.00	111.00	15.00	112.00	1
2	15.00	112.00	33.00	115.00	1
3	33.00	115.00	77.00	135.00	1
4	77.00	135.00	127.00	142.00	1
5	127.00	142.00	154.00	114.00	2
6	154.00	114.00	155.00	113.00	3
7	155.00	113.00	166.00	101.00	4
8	166.00	101.00	280.00	136.00	5
9	280.00	136.00	360.00	160.00	5
10	360.00	160.00	377.00	165.00	5
11	377.00	165.00	407.00	177.00	5
12	407.00	177.00	425.00	183.00	5
13	425.00	183.00	440.70	190.00	5
14	440.70	190.00	440.80	219.20	4
15	440.80	219.20	440.90	220.20	3
16	440.90	220.20	441.00	236.00	2
17	441.00	236.00	447.00	236.00	2
18	447.00	236.00	448.00	248.00	2
19	448.00	248.00	459.00	250.00	2
20	459.00	250.00	475.00	251.00	2
21	475.00	251.00	475.10	260.00	1
22	475.10	260.00	502.00	260.00	1
23	502.00	260.00	552.00	260.00	4
24	552.00	260.00	644.00	260.00	4
25	644.00	260.00	662.00	275.00	4
26	662.00	275.00	720.00	276.00	4
27	720.00	276.00	720.00	260.00	4
28	720.00	260.00	552.00	257.00	5
29	552.00	257.00	445.00	222.00	3
30	445.00	222.00	455.00	229.00	3
31	455.00	229.00	470.00	245.00	3
32	470.00	245.00	475.00	253.00	3
33	475.00	253.00	445.00	221.00	4
34	445.00	221.00	445.00	228.00	4
35	445.00	228.00	470.00	244.00	4
36	0.00	106.00	35.00	106.00	2
37	35.00	106.00	63.00	109.00	2
38	63.00	109.00	101.00	118.00	2
39	101.00	118.00	116.00	127.00	2
40	116.00	127.00	124.00	135.00	2

41	124.00	135.00	127.00	142.00	2
42	0.00	68.00	46.00	80.00	3
43	46.00	80.00	134.00	106.00	3
44	134.00	106.00	154.00	114.00	3
45	0.00	67.00	46.00	79.00	4
46	46.00	79.00	134.00	105.00	4
47	134.00	105.00	155.00	113.00	4
48	0.00	10.00	132.00	92.00	5
49	132.00	92.00	166.00	101.00	5
50	407.00	177.00	425.00	183.00	5
51	440.70	190.00	472.00	204.00	5
52	472.00	204.00	515.00	230.00	5
53	515.00	230.00	551.00	257.00	5
54	0.00	9.00	132.00	91.00	6
55	132.00	91.00	166.00	100.00	6
56	166.00	100.00	280.00	135.00	6
57	280.00	135.00	360.00	159.00	6
58	360.00	159.00	377.00	164.00	6
59	377.00	164.00	407.00	176.00	6
60	407.00	176.00	413.00	178.00	6
61	413.00	178.00	425.00	182.00	6
62	440.60	189.00	472.00	203.00	4
63	472.00	203.00	515.00	229.00	4
64	515.00	229.00	552.00	257.00	4
65	425.00	182.00	515.00	210.00	6
66	515.00	210.00	526.00	213.00	6
67	526.00	213.00	538.00	215.00	6
68	538.00	215.00	574.00	219.00	6
69	574.00	219.00	612.00	222.00	6
70	612.00	222.00	720.00	230.00	6

Default Y-Origin = 0.00(ft)
Default X-Plus Value = 0.00(ft)
Default Y-Plus Value = 0.00(ft)

ISOTROPIC SOIL PARAMETERS

6 Type(s) of Soil

Soil Type No.	Total (pcf)	Saturated (pcf)	Cohesion (psf)	Friction Angle (deg)	Pore Pressure Param. (psf)	Pressure Constant	Piez. Surface
1	130.0	130.0	200.0	29.0	0.00	0.00	0
2	130.0	130.0	270.0	19.0	0.00	0.00	0
3	130.0	130.0	270.0	19.0	0.00	0.00	0
4	130.0	130.0	500.0	30.0	0.00	0.00	0
5	130.0	130.0	270.0	19.0	0.00	0.00	0
6	130.0	130.0	1500.0	39.0	0.00	0.00	0

BOUNDARY LOAD(S)

1 Load(s) Specified

Load No.	X-Left (ft)	X-Right (ft)	Intensity (psf)	Deflection (deg)
1	502.00	637.00	500.0	0.0

NOTE - Intensity Is Specified As A Uniformly Distributed

Force Acting On A Horizontally Projected Surface.

Specified Peak Ground Acceleration Coefficient (A) = 0.300(g)

Specified Horizontal Earthquake Coefficient (kh) = 0.150(g)

Specified Vertical Earthquake Coefficient (kv) = 0.000(g)

Specified Seismic Pore-Pressure Factor = 0.000

TIEBACK LOAD(S)

2 Tieback Load(s) Specified

Tieback No.	X-Pos (ft)	Y-Pos (ft)	Load (lbs)	Spacing (ft)	Inclination (deg)	Length (ft)	Force Method
1	447.29	239.50	370000.0	5.0	25.00	65.0	2
2	447.71	244.50	370000.0	5.0	25.00	70.0	2

NOTE - An Equivalent Line Load Is Calculated For Each Row Of Tiebacks

Assuming A Uniform Distribution Of Load Horizontally Between Individual

Tiebacks. Force Method 1 Considers Only Tangential Tieback Forces.

Force Method 2 Considers Both Tangential and Normal Tieback Forces.

Force Method 3 Considers Only Normal Tieback Forces.

Force Method 4 Limits Normal and Tangential Tieback-Force Distribution

to 1.5 Times The Tieback Inclination, or to 30 Degrees Below (Left of)

the Tieback-Failure Surface Intersection, Whichever is Greater.

PIER/PILE LOAD(S)

1 Pier/Pile Load(s) Specified
 Pier/Pile X-Pos Y-Pos Load Spacing Inclination Length
 No. (ft) (ft) (lbs) (ft) (deg) (ft)
 1 441.10 236.00 250000.0 12.0 90.00 100.0
 NOTE - An Equivalent Line Load Is Calculated For Each Row Of Piers/Piles
 Assuming A Uniform Distribution Of Load Horizontally Between
 Individual Piers/Piles.

Janbus Empirical Coef is being used for the case of c & phi both > 0
 A Critical Failure Surface Searching Method, Using A Random
 Technique For Generating Sliding Block Surfaces, Has Been
 Specified.

8000 Trial Surfaces Have Been Generated.
 4 Boxes Specified For Generation Of Central Block Base
 Length Of Line Segments For Active And Passive Portions Of
 Sliding Block Is 60.0

Box No.	X-Left (ft)	Y-Left (ft)	X-Right (ft)	Y-Right (ft)	Height (ft)
1	440.80	189.50	446.00	189.50	5.00
2	470.00	204.00	474.00	204.00	5.00
3	513.00	230.00	517.00	230.00	5.00
4	550.00	257.00	554.00	257.00	2.00

The Factor Of Safety For The Trial Failure Surface Defined
 By The Coordinates Listed Below Is Misleading.
 Failure Surface Defined By 6 Coordinate Points

Point No.	X-Surf (ft)	Y-Surf (ft)
1	440.71	192.61
2	444.93	188.41
3	471.32	202.59
4	516.13	229.81
5	550.48	257.21
6	550.49	260.00

Factor Of Safety For The Preceding Specified Surface = -5.901
 The Factor Of Safety For The Trial Failure Surface Defined
 By The Coordinates Listed Below Is Misleading.

Failure Surface Defined By 6 Coordinate Points

Point No.	X-Surf (ft)	Y-Surf (ft)
1	440.71	192.61
2	444.93	188.41
3	471.32	202.59
4	516.13	229.81
5	550.48	257.21
6	550.49	260.00

Factor Of Safety For The Preceding Specified Surface = -5.901
 The Factor Of Safety For The Trial Failure Surface Defined
 By The Coordinates Listed Below Is Misleading.

Failure Surface Defined By 6 Coordinate Points

Point No.	X-Surf (ft)	Y-Surf (ft)
1	440.71	192.61
2	444.93	188.41
3	471.32	202.59
4	516.13	229.81
5	550.48	257.21
6	550.49	260.00

Factor Of Safety For The Preceding Specified Surface = -5.901
 The Factor Of Safety For The Trial Failure Surface Defined
 By The Coordinates Listed Below Is Misleading.

Failure Surface Defined By 6 Coordinate Points

Point No.	X-Surf (ft)	Y-Surf (ft)
1	440.71	192.61
2	444.93	188.41
3	471.32	202.59
4	516.13	229.81
5	550.48	257.21
6	550.49	260.00

Factor Of Safety For The Preceding Specified Surface = -5.901
 Following Are Displayed The Ten Most Critical Of The Trial

Failure Surfaces Evaluated. They Are
 Ordered - Most Critical First.
 * * Safety Factors Are Calculated By The Simplified Janbu Method * *
 Total Number of Trial Surfaces Attempted = 8000
 Number of Trial Surfaces with Misleading FS = 4
 Number of Trial Failure Surfaces is Greater Than 5000.
 Statistical Data on FS Values are Not Generated.
 To Generate Stastical Data, Reduce Number of Trial
 Failure Surfaces to 5000 or less.
 Failure Surface Specified By 6 Coordinate Points

Point No.	X-Surf (ft)	Y-Surf (ft)
1	440.702	190.706
2	441.187	190.225
3	471.530	203.424
4	513.184	228.103
5	552.135	257.892
6	553.013	260.000

Factor of Safety
 *** 1.109 ***

Individual data on the 22 slices

Slice No.	Width (ft)	Weight (lbs)	Water Force		Tie Force		Earthquake Force		Surcharge (lbs)	
			Top (lbs)	Bot (lbs)	Norm (lbs)	Tan (lbs)	Hor (lbs)	Ver (lbs)		
1	0.1	181.4	0.0	0.0	0.0	0.0	0.0	27.2	0.0	0.0
2	0.1	378.8	0.0	0.0	0.0	0.0	0.0	56.8	0.0	0.0
3	0.1	489.4	0.0	0.0	0.0	0.0	0.0	73.4	0.0	0.0
4	0.2	1109.9	0.0	0.0	0.0	0.0	0.0	166.5	0.0	0.0
5	0.6	3386.4	0.0	0.0	0.0	0.0	0.0	508.0	0.0	0.0
6	3.2	18893.5	0.0	0.0	1939.	0.	2834.0	0.0	0.0	0.0
7	2.0	11357.2	0.0	0.0	1430.	0.	1703.6	0.0	0.0	0.0
8	1.0	6373.8	0.0	0.0	786.	0.	956.1	0.0	0.0	0.0
9	7.0	49072.2	0.0	0.0	6919.	0.	7360.8	0.0	0.0	0.0
10	4.0	27317.2	0.0	0.0	5110.	0.	4097.6	0.0	0.0	0.0
11	11.0	71468.8	0.0	0.0	17849.	37.	10720.3	0.0	0.0	0.0
12	1.5	9476.7	0.0	0.0	2751.	364.	1421.5	0.0	0.0	0.0
13	0.5	2885.9	0.0	0.0	920.	30.	432.9	0.0	0.0	0.0
14	3.0	18063.1	0.0	0.0	6005.	453.	2709.5	0.0	0.0	0.0
15	0.1	649.9	0.0	0.0	203.	23.	97.5	0.0	0.0	0.0
16	26.9	162584.4	0.0	0.0	50864.	23368.	24387.7	0.0	0.0	0.0
17	11.2	51194.8	0.0	0.0	13563.	12799.	7679.2	0.0	5592.2	0.0
18	1.8	7365.1	0.0	0.0	2230.	1961.	1104.8	0.0	907.8	0.0
19	34.4	77594.6	0.0	0.0	25284.	33492.	11639.2	0.0	17188.0	0.0
20	2.6	1096.6	0.0	0.0	1182.	2105.	164.5	0.0	1312.0	0.0
21	0.1	38.0	0.0	0.0	59.	107.	5.7	0.0	67.7	0.0
22	0.9	120.2	0.0	0.0	1374.	849.	18.0	0.0	438.7	0.0

Failure Surface Specified By 6 Coordinate Points

Point No.	X-Surf (ft)	Y-Surf (ft)
1	440.702	190.706
2	441.187	190.225
3	471.530	203.424
4	513.184	228.103
5	552.135	257.892
6	553.013	260.000

Factor of Safety
 *** 1.109 ***

Failure Surface Specified By 6 Coordinate Points

Point No.	X-Surf (ft)	Y-Surf (ft)
1	440.702	190.706
2	441.187	190.225
3	471.530	203.424
4	513.184	228.103
5	552.135	257.892
6	553.013	260.000

Factor of Safety
 *** 1.109 ***

Failure Surface Specified By 6 Coordinate Points

Point No.	X-Surf (ft)	Y-Surf (ft)
1	440.702	190.706
2	441.187	190.225
3	471.530	203.424
4	513.184	228.103
5	552.135	257.892
6	553.013	260.000

Factor of Safety
*** 1.109 ***

Failure Surface Specified By 6 Coordinate Points

Point No.	X-Surf (ft)	Y-Surf (ft)
1	440.702	190.580
2	441.497	189.878
3	472.050	203.897
4	515.235	229.709
5	550.968	256.113
6	552.776	260.000

Factor of Safety
*** 1.115 ***

Failure Surface Specified By 6 Coordinate Points

Point No.	X-Surf (ft)	Y-Surf (ft)
1	440.702	190.580
2	441.497	189.878
3	472.050	203.897
4	515.235	229.709
5	550.968	256.113
6	552.776	260.000

Factor of Safety
*** 1.115 ***

Failure Surface Specified By 6 Coordinate Points

Point No.	X-Surf (ft)	Y-Surf (ft)
1	440.702	190.580
2	441.497	189.878
3	472.050	203.897
4	515.235	229.709
5	550.968	256.113
6	552.776	260.000

Factor of Safety
*** 1.115 ***

Failure Surface Specified By 6 Coordinate Points

Point No.	X-Surf (ft)	Y-Surf (ft)
1	440.702	190.580
2	441.497	189.878
3	472.050	203.897
4	515.235	229.709
5	550.968	256.113
6	552.776	260.000

Factor of Safety
*** 1.115 ***

Failure Surface Specified By 6 Coordinate Points

Point No.	X-Surf (ft)	Y-Surf (ft)
1	440.701	190.184
2	441.324	189.907
3	471.104	203.223
4	516.977	230.207
5	550.897	257.531
6	552.907	260.000

Factor of Safety
*** 1.152 ***

Failure Surface Specified By 6 Coordinate Points

Point No.	X-Surf (ft)	Y-Surf (ft)
1	440.701	190.184
2	441.324	189.907

3	471.104	203.223
4	516.977	230.207
5	550.897	257.531
6	552.907	260.000

Factor of Safety
*** 1.152 ***
**** END OF GSTABL7 OUTPUT ****

C-C' / Circular / Caissons and Tiebacks

z:\2010\10132-01 south shores church - dana point\engineering\2013_12\cc'_8c.pl2 Run By: BJE 12/5/2013 01:46PM

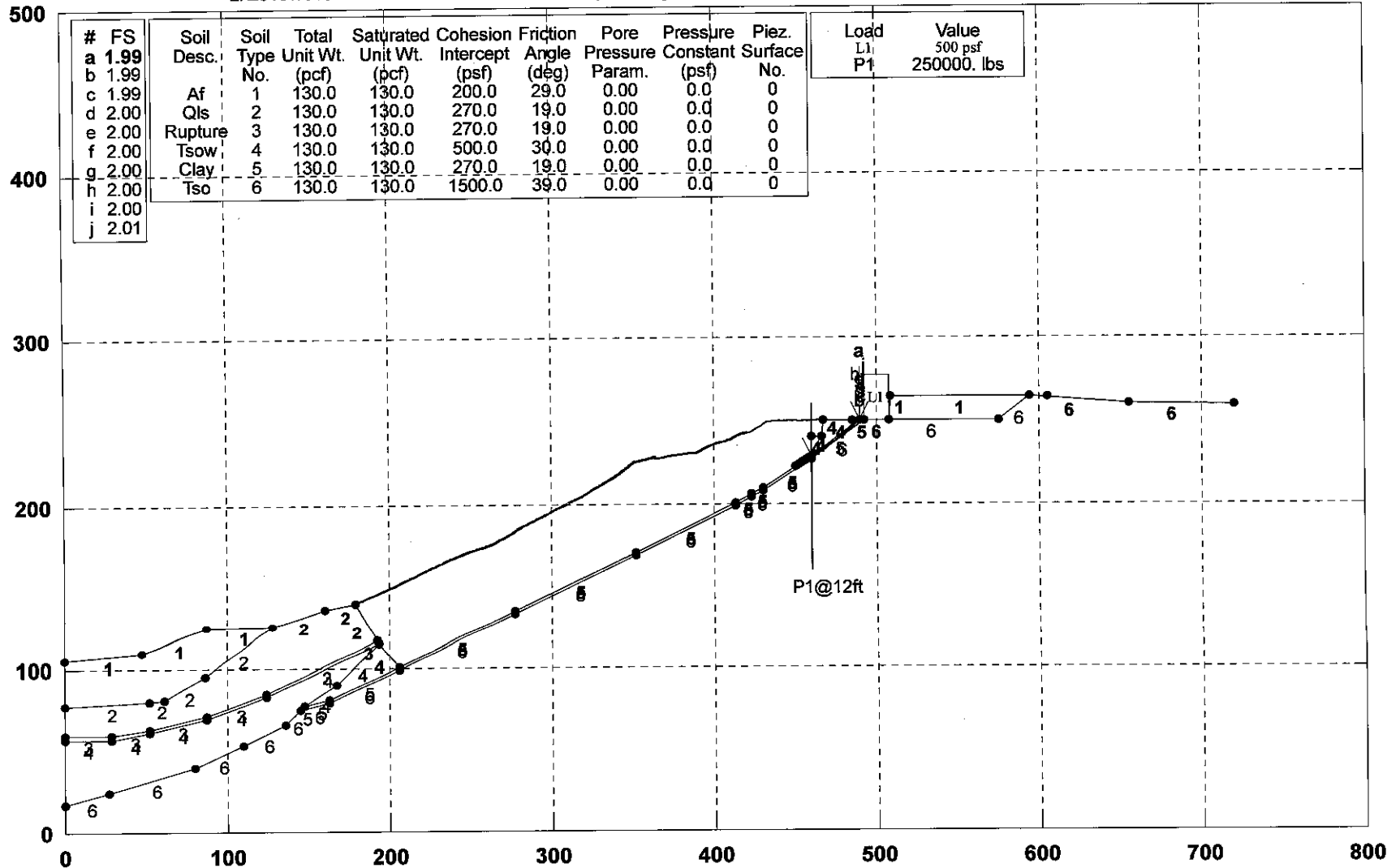

GSTABL7 v.2 FSmin=1.99

Safety Factors Are Calculated By The Modified Bishop Method

*** GSTABL7 ***

** GSTABL7 by Dr. Garry H. Gregory, Ph.D., P.E., D.GE **

** Original Version 1.0, January 1996; Current Ver. 2.005.2, Jan. 2011 **
 (All Rights Reserved-Unauthorized Use Prohibited)

SLOPE STABILITY ANALYSIS SYSTEM

Modified Bishop, Simplified Janbu, or GLE Method of Slices.
 (Includes Spencer & Morgenstern-Price Type Analysis)
 Including Pier/Pile, Reinforcement, Soil Nail, Tieback,
 Nonlinear Undrained Shear Strength, Curved Phi Envelope,
 Anisotropic Soil, Fiber-Reinforced Soil, Boundary Loads, Water
 Surfaces, Pseudo-Static & Newmark Earthquake, and Applied Forces.

Analysis Run Date: 12/5/2013
 Time of Run: 01:46PM
 Run By: BJE
 Input Data Filename: Z:\2010\10132-01 South Shores Church - Dana Point\Engineerin
 g\2013_12\cc'_8c.
 Output Filename: Z:\2010\10132-01 South Shores Church - Dana Point\Engineerin
 g\2013_12\cc'_8c.OUT
 Unit System: English
 Plotted Output Filename: Z:\2010\10132-01 South Shores Church - Dana Point\Engineerin
 g\2013_12\cc'_8c.PLT

PROBLEM DESCRIPTION: C-C' / Circular /
 Caissons and Tiebacks

BOUNDARY COORDINATES

24 Top Boundaries

60 Total Boundaries

Boundary No.	X-Left (ft)	Y-Left (ft)	X-Right (ft)	Y-Right (ft)	Soil Type Below Bnd
1	0.00	105.00	48.00	110.00	1
2	48.00	110.00	87.00	125.00	1
3	87.00	125.00	128.00	126.00	1
4	128.00	126.00	160.00	137.00	2
5	160.00	137.00	179.00	140.00	2
6	179.00	140.00	193.00	117.00	2
7	193.00	117.00	193.10	115.00	3
8	193.10	115.00	206.00	101.00	4
9	206.00	101.00	277.00	136.00	5
10	277.00	136.00	352.00	171.00	5
11	352.00	171.00	413.00	201.00	5
12	413.00	201.00	423.00	206.00	5
13	423.00	206.00	430.00	210.00	5
14	430.00	210.00	460.00	228.65	5
15	460.00	228.65	460.10	240.00	4
16	460.10	240.00	466.00	240.00	4
17	466.00	240.00	467.00	250.00	4
18	467.00	250.00	489.50	250.00	4
19	489.50	250.00	492.50	250.00	5
20	492.50	250.00	508.00	250.00	6
21	508.00	250.00	508.10	265.00	1
22	508.10	265.00	594.00	265.00	1
23	594.00	265.00	655.00	260.00	6
24	655.00	260.00	720.00	259.00	6
25	0.00	77.00	52.00	80.00	2
26	52.00	80.00	61.00	81.00	2
27	61.00	81.00	86.00	95.00	2
28	86.00	95.00	128.00	126.00	2
29	0.00	59.00	29.00	59.00	3
30	29.00	59.00	52.00	63.00	3
31	52.00	63.00	87.00	71.00	3
32	87.00	71.00	124.00	85.00	3
33	124.00	85.00	193.00	117.00	3
34	0.00	57.00	29.00	57.00	4
35	29.00	57.00	52.00	61.00	4
36	52.00	61.00	87.00	69.00	4
37	87.00	69.00	124.00	83.00	4
38	124.00	83.00	193.10	115.00	4
39	0.00	17.00	27.00	24.00	6
40	27.00	24.00	80.00	40.00	6

41	80.00	40.00	110.00	53.00	6
42	110.00	53.00	136.00	66.00	6
43	136.00	66.00	145.00	75.00	6
44	145.00	75.00	148.00	77.00	5
45	148.00	77.00	167.00	90.00	4
46	167.00	90.00	193.10	115.00	4
47	148.00	77.00	163.00	81.00	5
48	163.00	81.00	206.00	101.00	5
49	460.00	228.65	489.50	250.00	5
50	145.00	75.00	163.00	79.00	6
51	163.00	79.00	206.00	99.00	6
52	206.00	99.00	277.00	134.00	6
53	277.00	134.00	352.00	169.00	6
54	352.00	169.00	413.00	199.00	6
55	413.00	199.00	423.00	204.00	6
56	423.00	204.00	430.00	208.00	6
57	430.00	208.00	460.00	226.65	6
58	460.00	226.65	492.50	250.00	6
59	492.50	250.00	575.00	250.00	6
60	575.00	250.00	594.00	265.00	6

Default Y-Origin = 0.00(ft)
 Default X-Plus Value = 0.00(ft)
 Default Y-Plus Value = 0.00(ft)

ISOTROPIC SOIL PARAMETERS

6 Type(s) of Soil

Soil No.	Total (pcf)	Saturated (pcf)	Cohesion (psf)	Friction Angle (deg)	Pore Pressure Param. (psf)	Constant Surface	Piez. Surface
1	130.0	130.0	200.0	29.0	0.00	0.0	0
2	130.0	130.0	270.0	19.0	0.00	0.0	0
3	130.0	130.0	270.0	19.0	0.00	0.0	0
4	130.0	130.0	500.0	30.0	0.00	0.0	0
5	130.0	130.0	270.0	19.0	0.00	0.0	0
6	130.0	130.0	1500.0	39.0	0.00	0.0	0

BOUNDARY LOAD(S)

1 Load(s) Specified

Load No.	X-Left (ft)	X-Right (ft)	Intensity (psf)	Deflection (deg)
1	492.00	508.00	500.0	0.0

NOTE - Intensity Is Specified As A Uniformly Distributed Force Acting On A Horizontally Projected Surface.

TIEBACK LOAD(S)

2 Tieback Load(s) Specified

Tieback No.	X-Pos (ft)	Y-Pos (ft)	Load (lbs)	Spacing (ft)	Inclination (deg)	Length (ft)	Force Method
1	466.25	242.50	32000.0	5.0	25.00	50.0	2
2	466.75	247.50	32000.0	5.0	25.00	50.0	2

NOTE - An Equivalent Line Load Is Calculated For Each Row Of Tiebacks Assuming A Uniform Distribution Of Load Horizontally Between Individual Tiebacks. Force Method 1 Considers Only Tangential Tieback Forces. Force Method 2 Considers Both Tangential and Normal Tieback Forces. Force Method 3 Considers Only Normal Tieback Forces. Force Method 4 Limits Normal and Tangential Tieback-Force Distribution to 1.5 Times the Tieback Inclination, or to 30 Degrees Below (Left of) the Tieback-Failure Surface Intersection, Whichever is Greater.

TIEBACK ANCHOR LOAD DATA HAS BEEN SUPPRESSED

PIER/PILE LOAD(S)

1 Pier/Pile Load(s) Specified

Pier/Pile No.	X-Pos (ft)	Y-Pos (ft)	Load (lbs)	Spacing (ft)	Inclination (deg)	Length (ft)
1	460.20	240.00	250000.0	12.0	90.00	80.0

NOTE - An Equivalent Line Load Is Calculated For Each Row Of Piers/Piles Assuming A Uniform Distribution Of Load Horizontally Between Individual Piers/Piles.

A Critical Failure Surface Searching Method, Using A Random Technique For Generating Circular Surfaces, Has Been Specified.

5000 Trial Surfaces Have Been Generated.

500 Surface(s) Initiate(s) From Each Of 10 Points Equally Spaced Along The Ground Surface Between X = 450.00(ft) and X = 460.00(ft)

Each Surface Terminates Between X = 485.00(ft)
and X = 605.00(ft)

Unless Further Limitations Were Imposed, The Minimum Elevation
At Which A Surface Extends Is Y = 0.00(ft)

10.00(ft) Line Segments Define Each Trial Failure Surface.
Following Are Displayed The Ten Most Critical Of The Trial

Failure Surfaces Evaluated. They Are
Ordered - Most Critical First.

* * Safety Factors Are Calculated By The Modified Bishop Method * *

Total Number of Trial Surfaces Attempted = 5000

Number of Trial Surfaces With Valid FS = 5000

Statistical Data On All Valid FS Values:

FS Max = 11.866 FS Min = 1.987 FS Ave = 6.750

Standard Deviation = 2.041 Coefficient of Variation = 30.24 %

Failure Surface Specified By 5 Coordinate Points

Point No.	X-Surf (ft)	Y-Surf (ft)
1	460.000	228.653
2	468.387	234.100
3	476.573	239.843
4	484.549	245.876
5	489.614	250.000

Circle Center At X = 311.938 ; Y = 465.808 ; and Radius = 279.579

Factor of Safety

*** 1.987 ***

Individual data on the 9 slices

Slice No.	Width (ft)	Weight (lbs)	Water Force		Tie Force		Earthquake Norm (lbs)	Tie Tan (lbs)	Hor Ver Load (lbs)	Surcharge (lbs)
			Top (lbs)	Bot (lbs)	Force (lbs)	Force (lbs)				
1	0.0	15.8	0.0	0.0	0.0	0.0	0.0	0.0	0.0	0.0
2	0.1	57.5	0.0	0.0	0.0	0.0	0.0	0.0	0.0	0.0
3	5.9	7183.5	0.0	0.0	0.0	0.0	0.0	0.0	0.0	0.0
4	1.0	1576.2	0.0	0.0	0.0	0.0	0.0	0.0	0.0	0.0
5	1.4	2947.0	0.0	0.0	0.0	0.0	0.0	0.0	0.0	0.0
6	8.2	13864.9	0.0	0.0	0.0	0.0	0.0	0.0	0.0	0.0
7	8.0	7403.5	0.0	0.0	0.0	0.0	0.0	0.0	0.0	0.0
8	5.0	1357.4	0.0	0.0	0.0	0.0	0.0	0.0	0.0	0.0
9	0.1	0.7	0.0	0.0	0.0	0.0	0.0	0.0	0.0	0.0

Failure Surface Specified By 5 Coordinate Points

Point No.	X-Surf (ft)	Y-Surf (ft)
1	460.000	228.653
2	468.281	234.259
3	476.438	240.045
4	484.465	246.008
5	489.600	250.000

Circle Center At X = 208.668 ; Y = 608.889 ; and Radius = 455.792

Factor of Safety

*** 1.989 ***

Failure Surface Specified By 5 Coordinate Points

Point No.	X-Surf (ft)	Y-Surf (ft)
1	460.000	228.653
2	468.640	233.688
3	476.950	239.251
4	484.897	245.321
5	490.288	250.000

Circle Center At X = 383.645 ; Y = 369.633 ; and Radius = 160.329

Factor of Safety

*** 1.992 ***

Failure Surface Specified By 5 Coordinate Points

Point No.	X-Surf (ft)	Y-Surf (ft)
1	460.000	228.653
2	468.177	234.410
3	476.305	240.236
4	484.383	246.130
5	489.596	250.000

Circle Center At X = -220.387 ; Y = 1203.693 ; and Radius = 1188.962

Factor of Safety

*** 1.995 ***

Failure Surface Specified By 5 Coordinate Points

Point No.	X-Surf (ft)	Y-Surf (ft)
1	460.000	228.653
2	468.290	234.247
3	476.517	239.930
4	484.682	245.704
5	490.619	250.000

Circle Center At X = -46.347 ; Y = 988.035 ; and Radius = 912.714

Factor of Safety

*** 1.997 ***

Failure Surface Specified By 5 Coordinate Points

Point No.	X-Surf (ft)	Y-Surf (ft)
1	460.000	228.653
2	468.227	234.338
3	476.359	240.158
4	484.392	246.114
5	489.457	250.000

Circle Center At X = 122.817 ; Y = 725.477 ; and Radius = 600.438

Factor of Safety

*** 1.999 ***

Failure Surface Specified By 5 Coordinate Points

Point No.	X-Surf (ft)	Y-Surf (ft)
1	460.000	228.653
2	468.488	233.941
3	476.675	239.683
4	484.537	245.863
5	489.247	250.000

Circle Center At X = 367.335 ; Y = 386.870 ; and Radius = 183.356

Factor of Safety

*** 2.000 ***

Failure Surface Specified By 6 Coordinate Points

Point No.	X-Surf (ft)	Y-Surf (ft)
1	451.111	223.124
2	460.081	227.544
3	468.543	232.872
4	476.405	239.053
5	483.581	246.017
6	486.910	250.000

Circle Center At X = 414.247 ; Y = 309.507 ; and Radius = 93.920

Factor of Safety

*** 2.003 ***

Failure Surface Specified By 5 Coordinate Points

Point No.	X-Surf (ft)	Y-Surf (ft)
1	460.000	228.653
2	468.499	233.922
3	476.867	239.398
4	485.097	245.078
5	491.869	250.000

Circle Center At X = 249.611 ; Y = 577.529 ; and Radius = 407.403

Factor of Safety

*** 2.003 ***

Failure Surface Specified By 5 Coordinate Points

Point No.	X-Surf (ft)	Y-Surf (ft)
1	460.000	228.653
2	468.355	234.149
3	476.691	239.672
4	485.010	245.221
5	492.124	250.000

Circle Center At X = -1238.204 ; Y = 2819.371 ; and Radius = 3097.695

Factor of Safety

*** 2.006 ***

**** END OF GSTABL7 OUTPUT ****

C-C' / Circular / Caissons and Tiebacks / Pseudo

z:\2010\10132-01 south shores church - dana point\engineering\2013_12\cc'_8cp.pl2 Run By: BJE 12/5/2013 01:47PM

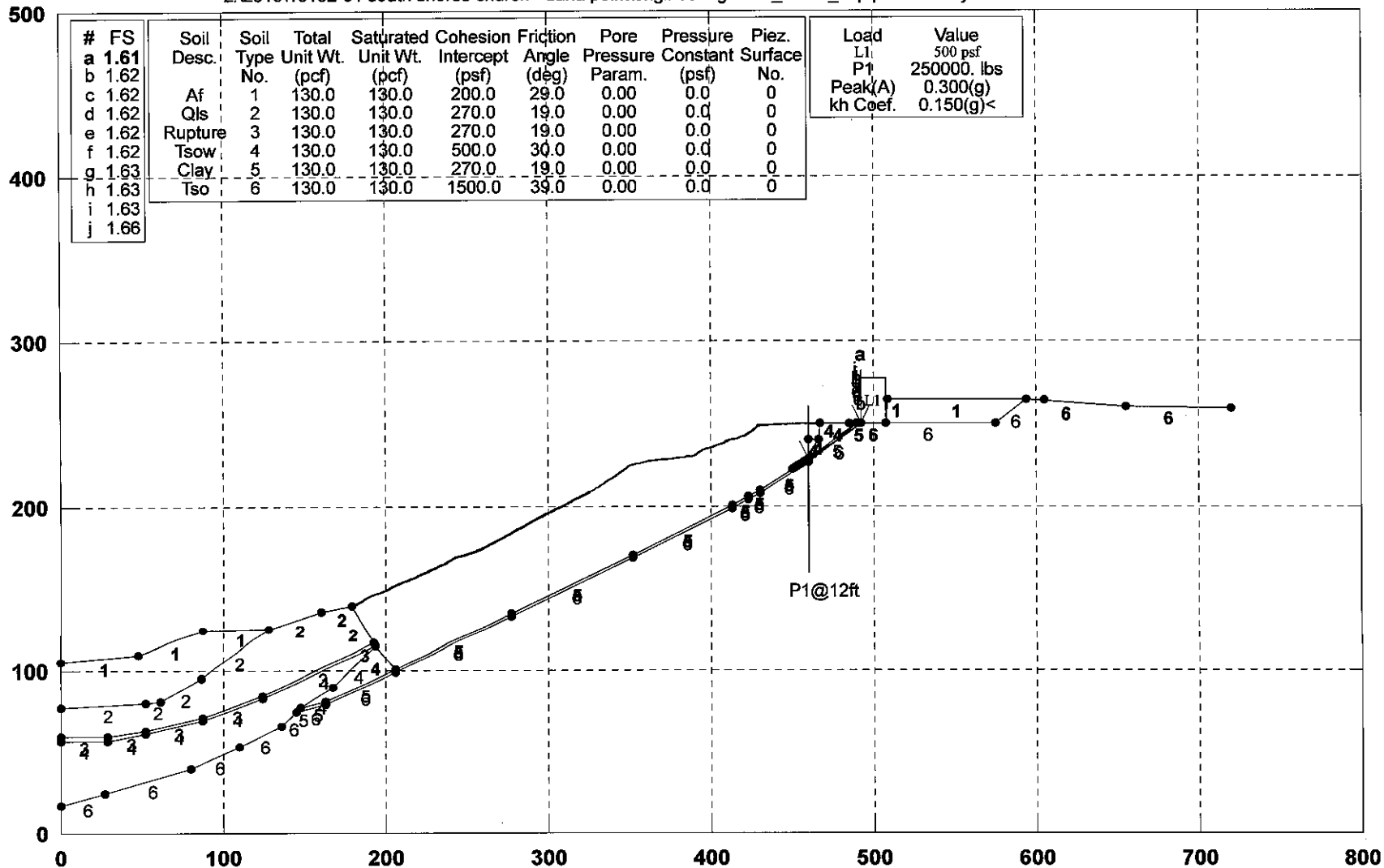

GSTABL7 v.2 FSmin=1.61

Safety Factors Are Calculated By The Modified Bishop Method

*** GSTABL7 ***

** GSTABL7 by Dr. Garry H. Gregory, Ph.D., P.E., D.GE **

** Original Version 1.0, January 1996; Current Ver. 2.005.2, Jan. 2011 **
 (All Rights Reserved-Unauthorised Use Prohibited)

SLOPE STABILITY ANALYSIS SYSTEM

Modified Bishop, Simplified Janbu, or GLE Method of Slices.
 (Includes Spencer & Morgenstern-Price Type Analysis)
 Including Pier/Pile, Reinforcement, Soil Nail, Tieback,
 Nonlinear Undrained Shear Strength, Curved Phi Envelope,
 Anisotropic Soil, Fiber-Reinforced Soil, Boundary Loads, Water
 Surfaces, Pseudo-Static & Newmark Earthquake, and Applied Forces.

Analysis Run Date: 12/5/2013
 Time of Run: 01:47PM
 Run By: BJE
 Input Data Filename: Z:\2010\10132-01 South Shores Church - Dana Point\Engineerin
 g\2013_12\cc'_8cp.
 Output Filename: Z:\2010\10132-01 South Shores Church - Dana Point\Engineerin
 g\2013_12\cc'_8cp.OUT
 Unit System: English
 Plotted Output Filename: Z:\2010\10132-01 South Shores Church - Dana Point\Engineerin
 g\2013_12\cc'_8cp.PLT

PROBLEM DESCRIPTION: C-C' / Circular /
 Caissons and Tiebacks / Pseudo

BOUNDARY COORDINATES

24 Top Boundaries
 60 Total Boundaries

Boundary No.	X-Left (ft)	Y-Left (ft)	X-Right (ft)	Y-Right (ft)	Soil Type Below Bnd
1	0.00	105.00	48.00	110.00	1
2	48.00	110.00	87.00	125.00	1
3	87.00	125.00	128.00	126.00	1
4	128.00	126.00	160.00	137.00	2
5	160.00	137.00	179.00	140.00	2
6	179.00	140.00	193.00	117.00	2
7	193.00	117.00	193.10	115.00	3
8	193.10	115.00	206.00	101.00	4
9	206.00	101.00	277.00	136.00	5
10	277.00	136.00	352.00	171.00	5
11	352.00	171.00	413.00	201.00	5
12	413.00	201.00	423.00	206.00	5
13	423.00	206.00	430.00	210.00	5
14	430.00	210.00	460.00	228.65	5
15	460.00	228.65	460.10	240.00	4
16	460.10	240.00	466.00	240.00	4
17	466.00	240.00	467.00	250.00	4
18	467.00	250.00	489.50	250.00	4
19	489.50	250.00	492.50	250.00	5
20	492.50	250.00	508.00	250.00	6
21	508.00	250.00	508.10	265.00	1
22	508.10	265.00	594.00	265.00	1
23	594.00	265.00	655.00	260.00	6
24	655.00	260.00	720.00	259.00	6
25	0.00	77.00	52.00	80.00	2
26	52.00	80.00	61.00	81.00	2
27	61.00	81.00	86.00	95.00	2
28	86.00	95.00	128.00	126.00	2
29	0.00	59.00	29.00	59.00	3
30	29.00	59.00	52.00	63.00	3
31	52.00	63.00	87.00	71.00	3
32	87.00	71.00	124.00	85.00	3
33	124.00	85.00	193.00	117.00	3
34	0.00	57.00	29.00	57.00	4
35	29.00	57.00	52.00	61.00	4
36	52.00	61.00	87.00	69.00	4
37	87.00	69.00	124.00	83.00	4
38	124.00	83.00	193.10	115.00	4
39	0.00	17.00	27.00	24.00	6
40	27.00	24.00	80.00	40.00	6

41	80.00	40.00	110.00	53.00	6
42	110.00	53.00	136.00	66.00	6
43	136.00	66.00	145.00	75.00	6
44	145.00	75.00	148.00	77.00	5
45	148.00	77.00	167.00	90.00	4
46	167.00	90.00	193.10	115.00	4
47	148.00	77.00	163.00	81.00	5
48	163.00	81.00	206.00	101.00	5
49	460.00	228.65	489.50	250.00	5
50	145.00	75.00	163.00	79.00	6
51	163.00	79.00	206.00	99.00	6
52	206.00	99.00	277.00	134.00	6
53	277.00	134.00	352.00	169.00	6
54	352.00	169.00	413.00	199.00	6
55	413.00	199.00	423.00	204.00	6
56	423.00	204.00	430.00	208.00	6
57	430.00	208.00	460.00	226.65	6
58	460.00	226.65	492.50	250.00	6
59	492.50	250.00	575.00	250.00	6
60	575.00	250.00	594.00	265.00	6

Default Y-Origin = 0.00(ft)
 Default X-Plus Value = 0.00(ft)
 Default Y-Plus Value = 0.00(ft)

ISOTROPIC SOIL PARAMETERS

6 Type(s) of Soil

Soil No.	Total (pcf)	Saturated (pcf)	Cohesion (psf)	Friction (deg)	Pore Pressure Param. (psf)	Pressure Constant	Piez. Surface
1	130.00	130.00	200.00	29.00	0.00	0.00	0
2	130.00	130.00	270.00	19.00	0.00	0.00	0
3	130.00	130.00	270.00	19.00	0.00	0.00	0
4	130.00	130.00	500.00	30.00	0.00	0.00	0
5	130.00	130.00	270.00	19.00	0.00	0.00	0
6	130.00	130.00	1500.00	39.00	0.00	0.00	0

BOUNDARY LOAD(S)

1 Load(s) Specified

Load No.	X-Left (ft)	X-Right (ft)	Intensity (psf)	Deflection (deg)
1	492.00	508.00	500.00	0.00

NOTE - Intensity Is Specified As A Uniformly Distributed Force Acting On A Horizontally Projected Surface.

Specified Peak Ground Acceleration Coefficient (A) = 0.300(g)

Specified Horizontal Earthquake Coefficient (kh) = 0.150(g)

Specified Vertical Earthquake Coefficient (kv) = 0.000(g)

Specified Seismic Pore-Pressure Factor = 0.000

TIEBACK LOAD(S)

2 Tieback Load(s) Specified

Tieback No.	X-Pos (ft)	Y-Pos (ft)	Load (lbs)	Spacing (ft)	Inclination (deg)	Length (ft)	Force Method
1	466.25	242.50	32000.00	5.0	25.00	50.0	2
2	466.75	247.50	32000.00	5.0	25.00	50.0	2

NOTE - An Equivalent Line Load Is Calculated For Each Row Of Tiebacks Assuming A Uniform Distribution Of Load Horizontally Between Individual Tiebacks. Force Method 1 Considers Only Tangential Tieback Forces.

Force Method 2 Considers Both Tangential and Normal Tieback Forces.

Force Method 3 Considers Only Normal Tieback Forces.

Force Method 4 Limits Normal and Tangential Tieback-Force Distribution to 1.5 Times the Tieback Inclination, or to 30 Degrees Below (Left of) the Tieback-Failure Surface Intersection, Whichever is Greater.

TIEBACK ANCHOR LOAD DATA HAS BEEN SUPPRESSED

PIER/PILE LOAD(S)

1 Pier/Pile Load(s) Specified

Pier/Pile No.	X-Pos (ft)	Y-Pos (ft)	Load (lbs)	Spacing (ft)	Inclination (deg)	Length (ft)
1	460.20	240.00	250000.00	12.0	90.00	80.0

NOTE - An Equivalent Line Load Is Calculated For Each Row Of Piers/Piles Assuming A Uniform Distribution Of Load Horizontally Between Individual Piers/Piles.

A Critical Failure Surface Searching Method, Using A Random Technique For Generating Circular Surfaces, Has Been Specified.

5000 Trial Surfaces Have Been Generated.
 500 Surface(s) Initiate(s) From Each Of 10 Points Equally Spaced
 Along The Ground Surface Between X = 450.00(ft)
 and X = 460.00(ft)
 Each Surface Terminates Between X = 485.00(ft)
 and X = 605.00(ft)

Unless Further Limitations Were Imposed, The Minimum Elevation
 At Which A Surface Extends Is Y = 0.00(ft)
 10.00(ft) Line Segments Define Each Trial Failure Surface.
 Following Are Displayed The Ten Most Critical Of The Trial

Failure Surfaces Evaluated. They Are
 Ordered - Most Critical First.

* * Safety Factors Are Calculated By The Modified Bishop Method * *

Total Number of Trial Surfaces Attempted = 5000

Number of Trial Surfaces With Valid FS = 5000

Statistical Data On All Valid FS Values:

FS Max = 7.933 FS Min = 1.613 FS Ave = 4.421
 Standard Deviation = 0.955 Coefficient of Variation = 21.60 %

Failure Surface Specified By 5 Coordinate Points

Point No.	X-Surf (ft)	Y-Surf (ft)
1	460.000	228.653
2	468.499	233.922
3	476.867	239.398
4	485.097	245.078
5	491.869	250.000

Circle Center At X = 249.611 ; Y = 577.529 ; and Radius = 407.403

Factor of Safety
 *** 1.613 ***

Individual data on the 9 slices

Slice No.	Width (ft)	Weight (lbs)	Water Force (lbs)		Tie Force (lbs)		Earthquake Norm (lbs)	Tie Tan (lbs)	Earthquake Hor Ver Load (lbs)	Surcharge (lbs)
			Top	Bot	Top	Bot				
1	0.0	8.1	0.0	0.0	0.0	0.0	1.2	0.0	0.0	0.0
2	0.1	65.3	0.0	0.0	0.0	0.0	9.8	0.0	0.0	0.0
3	5.9	7252.6	0.0	0.0	0.0	0.0	1087.9	0.0	0.0	0.0
4	1.0	1601.2	0.0	0.0	0.0	0.0	240.2	0.0	0.0	0.0
5	1.5	3224.5	0.0	0.0	0.0	0.0	483.7	0.0	0.0	0.0
6	8.4	14510.6	0.0	0.0	0.0	0.0	2176.6	0.0	0.0	0.0
7	8.2	8305.1	0.0	0.0	0.0	0.0	1245.8	0.0	0.0	0.0
8	4.4	1901.3	0.0	0.0	0.0	0.0	285.2	0.0	0.0	0.0
9	2.4	265.1	0.0	0.0	0.0	0.0	39.8	0.0	0.0	0.0

Failure Surface Specified By 5 Coordinate Points

Point No.	X-Surf (ft)	Y-Surf (ft)
1	460.000	228.653
2	468.355	234.149
3	476.691	239.672
4	485.010	245.221
5	492.124	250.000

Circle Center At X = -1238.204 ; Y = 2819.371 ; and Radius = 3097.695

Factor of Safety
 *** 1.615 ***

Failure Surface Specified By 5 Coordinate Points

Point No.	X-Surf (ft)	Y-Surf (ft)
1	460.000	228.653
2	468.640	233.688
3	476.950	239.251
4	484.897	245.321
5	490.288	250.000

Circle Center At X = 383.645 ; Y = 369.633 ; and Radius = 160.329

Factor of Safety
 *** 1.617 ***

Failure Surface Specified By 5 Coordinate Points

Point No.	X-Surf (ft)	Y-Surf (ft)
1	460.000	228.653
2	468.290	234.247

3	476.517	239.930
4	484.682	245.704
5	490.619	250.000

Circle Center At X = -46.347 ; Y = 988.035 ; and Radius = 912.714

Factor of Safety
 *** 1.620 ***

Failure Surface Specified By 5 Coordinate Points

Point No.	X-Surf (ft)	Y-Surf (ft)
1	460.000	228.653
2	468.387	234.100
3	476.573	239.843
4	484.549	245.876
5	489.614	250.000

Circle Center At X = 311.938 ; Y = 465.808 ; and Radius = 279.579

Factor of Safety
 *** 1.621 ***

Failure Surface Specified By 5 Coordinate Points

Point No.	X-Surf (ft)	Y-Surf (ft)
1	460.000	228.653
2	468.281	234.259
3	476.438	240.045
4	484.465	246.008
5	489.600	250.000

Circle Center At X = 208.668 ; Y = 608.889 ; and Radius = 455.792

Factor of Safety
 *** 1.624 ***

Failure Surface Specified By 5 Coordinate Points

Point No.	X-Surf (ft)	Y-Surf (ft)
1	460.000	228.653
2	468.177	234.410
3	476.305	240.236
4	484.383	246.130
5	489.596	250.000

Circle Center At X = -220.387 ; Y = 1203.693 ; and Radius = 1188.962

Factor of Safety
 *** 1.629 ***

Failure Surface Specified By 5 Coordinate Points

Point No.	X-Surf (ft)	Y-Surf (ft)
1	460.000	228.653
2	468.227	234.338
3	476.359	240.158
4	484.392	246.114
5	489.457	250.000

Circle Center At X = 122.817 ; Y = 725.477 ; and Radius = 600.438

Factor of Safety
 *** 1.633 ***

Failure Surface Specified By 5 Coordinate Points

Point No.	X-Surf (ft)	Y-Surf (ft)
1	460.000	228.653
2	468.488	233.941
3	476.675	239.683
4	484.537	245.863
5	489.247	250.000

Circle Center At X = 367.335 ; Y = 386.870 ; and Radius = 183.356

Factor of Safety
 *** 1.634 ***

Failure Surface Specified By 5 Coordinate Points

Point No.	X-Surf (ft)	Y-Surf (ft)
1	460.000	228.653
2	468.383	234.106
3	476.509	239.933
4	484.364	246.123
5	488.851	250.000

Circle Center At X = 343.892 ; Y = 416.312 ; and Radius = 220.673

Z:\2010\10132-01 South Shores Church - Dana Point\Engineering\2013_12\cc'_8cp.OUT Page 5

Factor of Safety
*** 1.662 ***
**** END OF GSTABL7 OUTPUT ****

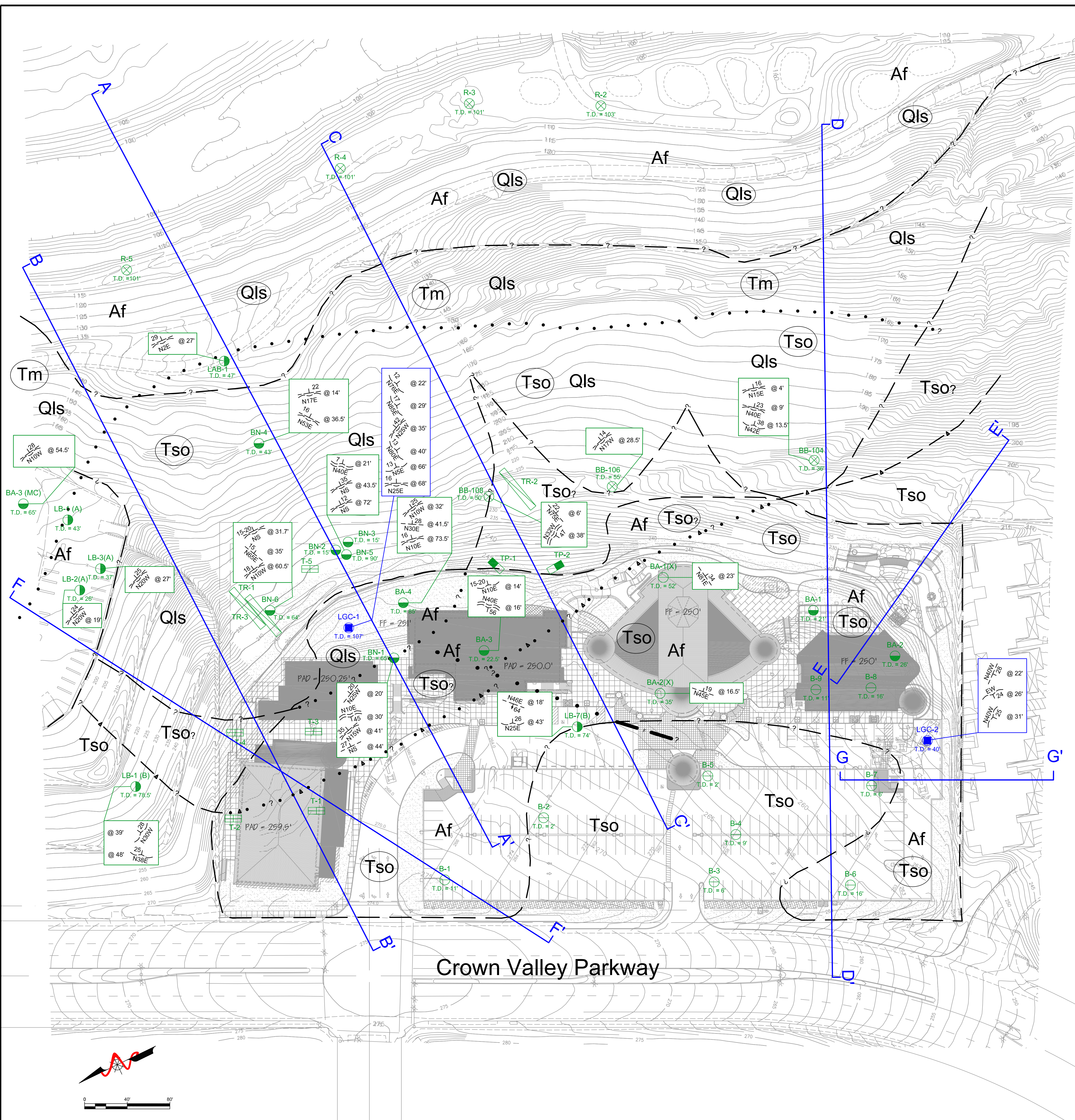

LEGEND

Approximate Locations of Borings and Trenches with Total Depth in Feet (Borings Only):

- LGC-1 Recent Borings by LGC Geotechnical, Inc.
- B-9 Hollow Stem Boring by Nicoll (2006)
- BA-2(X) Bucket Auger Boring by Nicoll (1993)
- BA-4 Bucket Auger Boring by Nicoll (2006)
- BN-6 Bucket Auger Boring by Nicoll (2007)
- T-5 Test Pit by Nicoll (2006b)
- ▭ TR-3 Trench by Nicoll (2007)
- ▭ TP-2 Test Pit by Nicoll (2006a)
- BA-3 (MC) Bucket Auger Boring for Monarch Coast Apartments by Nicoll (2007)
- LB-3(A) Bucket Auger Boring by Moran (1977)
- LB-7(B) Bucket Auger Boring by Leighton & Associates (1985) from Nicoll (1993)
- LAB-1 Bucket Auger Boring by Leighton & Associates (1986)
- BB-108 Bucket Auger Boring by Agra (2000)
- R-5 Rotary Wash Boring by Agra (2000)

Earth Units (Circled Where Buried):

- Af** Artificial Fill
- Qls** Quaternary Landslide
- Tm** Tertiary Monterey Formation
- Tso** Tertiary San Onofre Formation

Map and Cross Section Symbols:

- · - · Approximate Location of Geologic Contact, Dotted Where Buried, Queried Where Uncertain
- · - · Approximate Location of Fault, Dotted Where Buried, Queried Where Uncertain
- · - · Approximate Location of Geologic Silty Clay Bed, Dotted Where Buried, Queried Where Uncertain
- ↔ Approximate Cross Section Alignment
- N40W / 28 @ 22' Bedding Attitude with Depth in Feet (Dashed Where Buried)
- N5E / 66 @ 66' General Bedding Attitude with Depth in Feet (Dashed Where Buried)
- N35 / N15W @ 41' Rupture Surface Attitude with Depth in Feet (Dashed Where Buried)
- N46E / 64 @ 18' Fault Attitude with Depth in Feet (Dashed Where Buried)



LGC GEOTECHNICAL, INC.
 120 Calle Iglesia
 San Clemente, CA 92672
 TEL (949) 369-6141 FAX (949) 369-6142





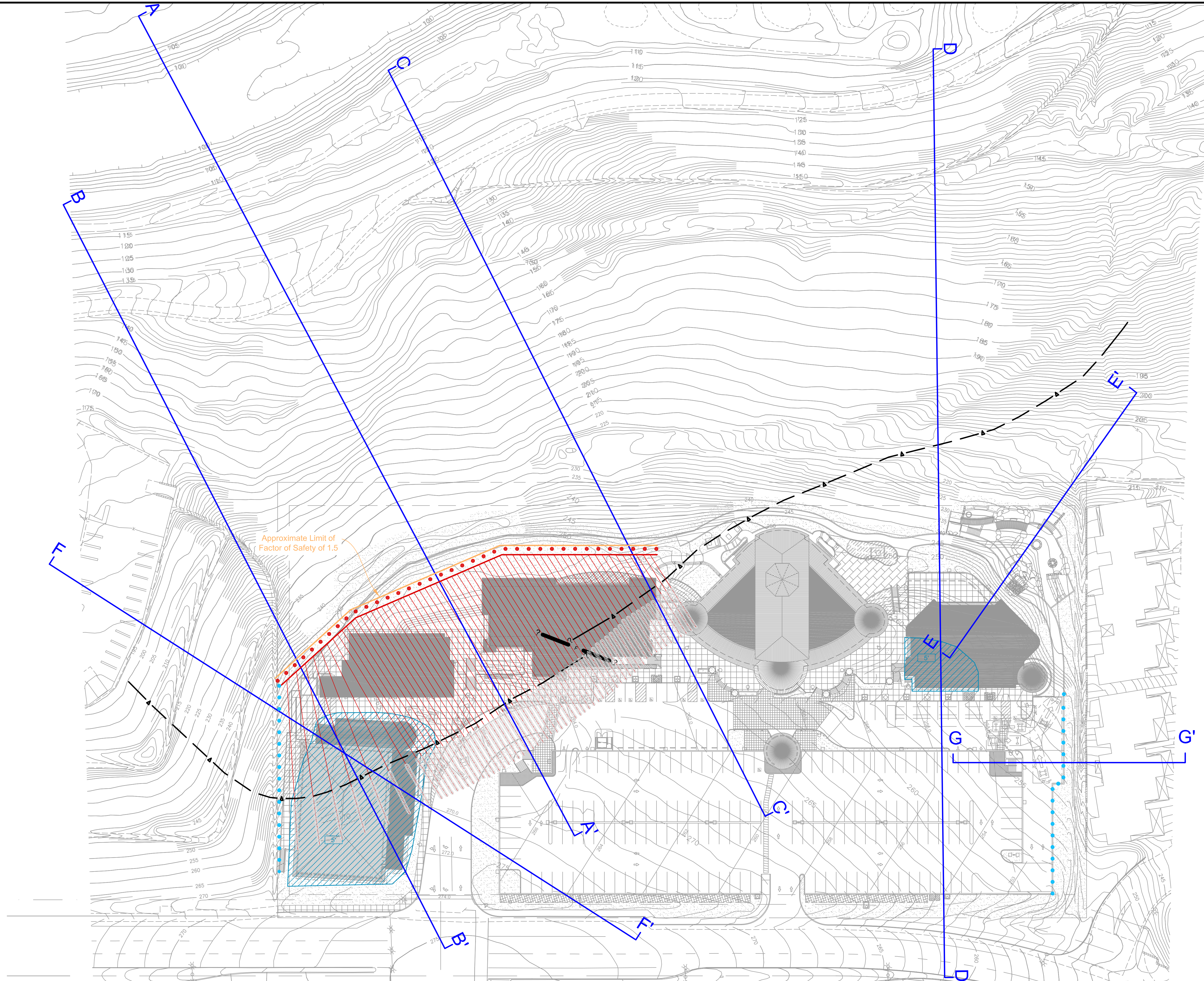

**South Shores Church - Alternative Design
 Geotechnical Map**

CLIENT:
 South Shores Church
 32712 Crown Valley Parkway
 Dana Point, California

PROJECT NAME	South Shores Church
PROJECT NO.	10132-01
ENG. / GEOL.	TJL / KTM
SCALE	1" = 40'
DATE	December 2013

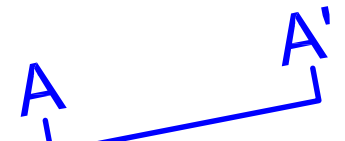
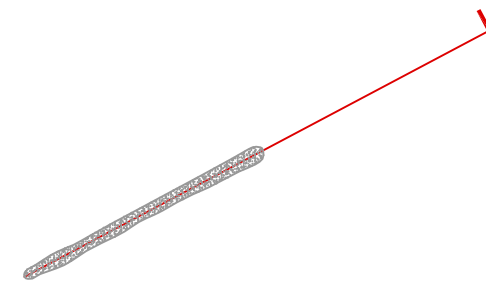

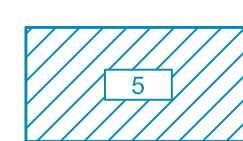
LEGEND

-  Approximate Location of Silty Clay Bed
(Engineered Fill Overlies Majority of Feature, Not Depicted)
-  Approximate Location of Fault
-  Cross Section Alignment
-  Approximate Location of Tieback Column Relative to Reaction Wall
Number of Tiebacks in Columns Vary
Tiebacks to be Spaced 5 Feet on Center
-  Approximate Location of Caissons to be Installed in Front of Reaction Wall
(To Be Connected by Grade Beams)
-  Approximate Location of Over-Excavation with Depth in Feet
-  Approximate Location of Caissons for Deepened Footing
(To Be Connected by Grade Beams)



LGC GEOTECHNICAL, INC.
 120 Calle Iglesia, Ste. A
 San Clemente, CA 92672
 TEL (949) 369-6141 FAX (949) 369-6142

**South Shores Church - Alternative Design
 Preliminary Remedial Measures Map**

CLIENT:
 South Shores Church
 32712 Crown Valley Parkway
 Dana Point, California

PROJECT NAME	South Shores Church
PROJECT NO.	10132-01
ENG. / GEOL.	TJL / KTM
SCALE	1" = 40'
DATE	December 2013

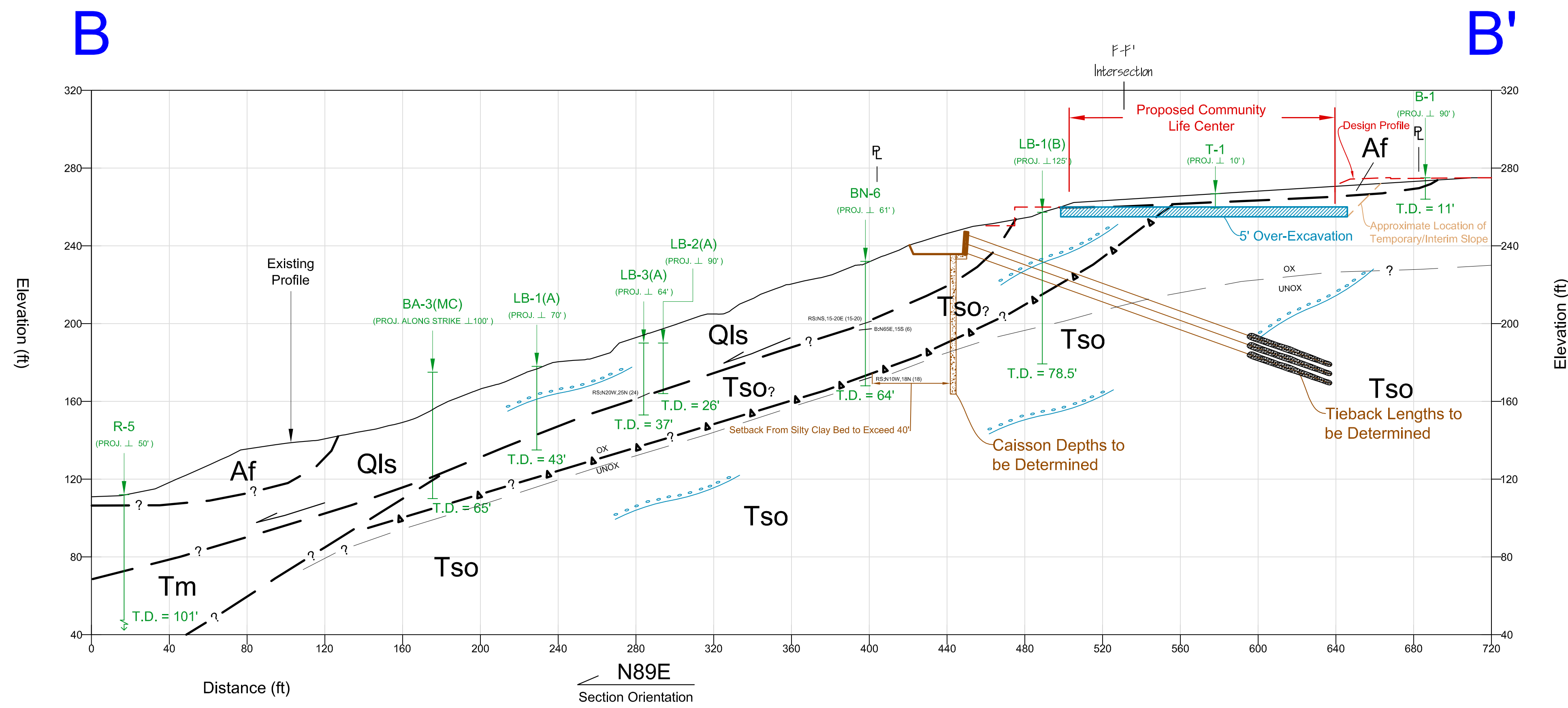
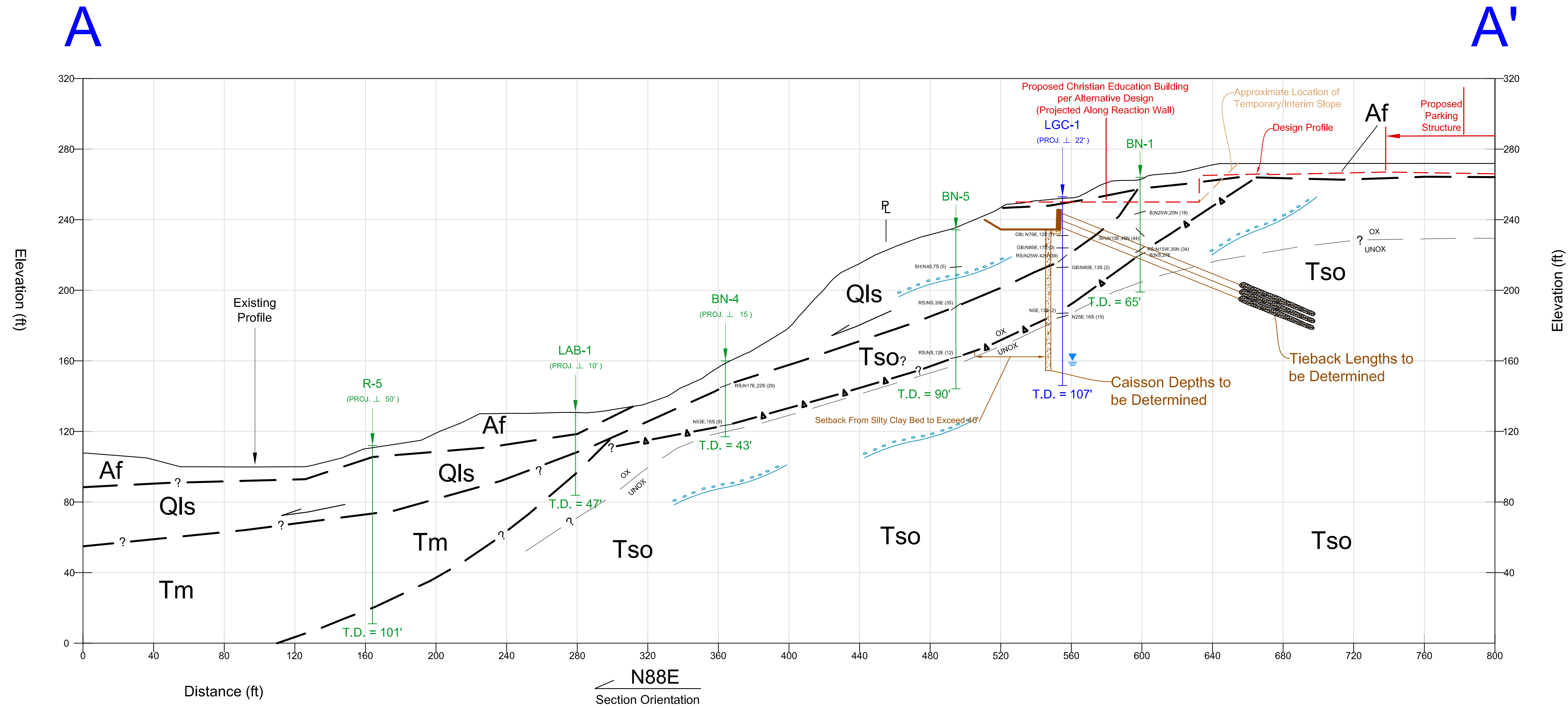

LGC GEOTECHNICAL, INC.
 120 Calle Iglesia, Ste. A
 San Clemente, CA 92672
 TEL (949) 369-6141 FAX (949) 369-6142

**South Shores Church - Alternative Design
 Geotechnical Cross Sections A-A' and B-B'**

CLIENT:
 South Shores Church
 32712 Crown Valley Parkway
 Dana Point, California

PROJECT NAME	South Shores Church
PROJECT NO.	10132-01
ENG. / GEOL.	TJL / KTM
SCALE	1" = 40'
DATE	December 2013

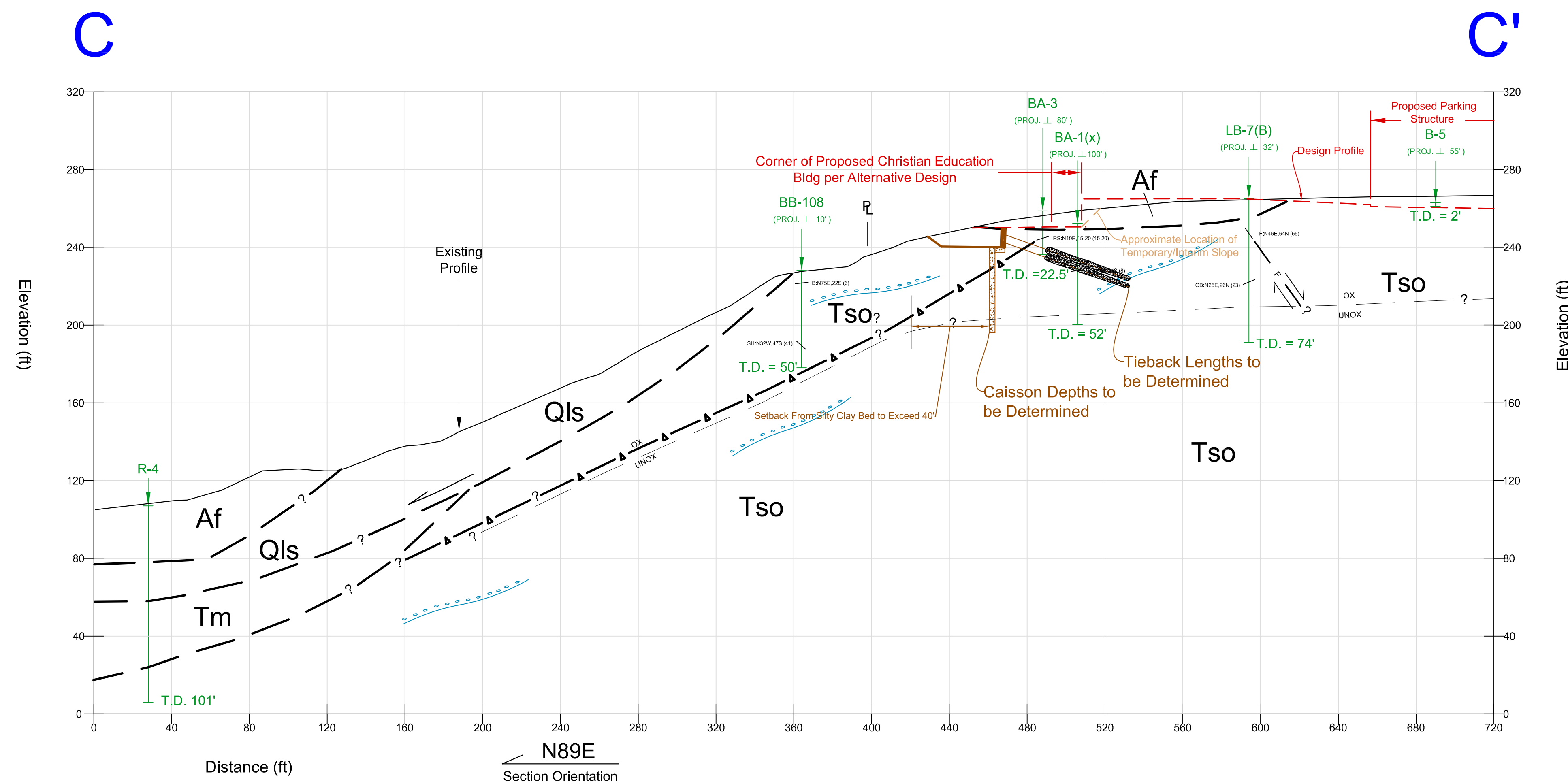

LGC GEOTECHNICAL, INC.
 120 Calle Iglesia, Ste. A
 San Clemente, CA 92672
 TEL (949) 369-6141 FAX (949) 369-6142

**South Shores Church - Alternative Design
 Geotechnical Cross Section C-C'**

CLIENT:
 South Shores Church
 32712 Crown Valley Parkway
 Dana Point, California

PROJECT NAME	South Shores Church
PROJECT NO.	10132-01
ENG. / GEOL.	TJL / KTM
SCALE	1" = 40'
DATE	December 2013